

**EXPLORING PSYCHOLOGICAL RESILIENCE AMONG
PRE-ADOLESCENTS ORPHANED BY AIDS:
A CASE STUDY**

Anja Pienaar

"Pure, unspoil religion, in the eyes of God our Father is thus:
coming to the help of widows and orphans when they need it".
James 1:27

EXPLORING PSYCHOLOGICAL RESILIENCE AMONG PRE-ADOLESCENTS ORPHANED BY AIDS: A CASE STUDY

by

Anja Pienaar

(B.A. Fine Arts, P.G.D.E., B. Ed. Hon.)

Dissertation

Submitted in accordance with the partial requirements for the degree

MAGISTER EDUCATIONIS

**Faculty of Humanities
Department of Psychology of Education
University of the Free State
Bloemfontein**

June 2007

**Supervisors:
Dr. Z. Swanepoel
Prof H.C.J. van Rensburg**

The financial assistance of the National Research Foundation (NRF) towards this research is hereby acknowledged. Opinions expressed and conclusions arrived at are those of the author and are not necessarily to be attributed to the National Research Foundation.

Declaration

I declare that the dissertation hereby submitted by me for the MAGISTER EDUCATIONIS degree at the University of the Free State is my own independent work and has not previously been submitted by me at another university or faculty. All the sources I have used or quoted have been indicated and acknowledged by means of complete references. I further cede copyright of this thesis in favour of the University of the Free State.

.....
A. PIENAAR

.....
DATE

Dedicated, in loving memory, to my grandfather
Cornelis, Antonie van Ee

Acknowledgements

I wish to express my sincere gratitude and appreciation to:

- Mrs Avril Snyman (Administrator of Lebone Land), for authorising the study.
- The eight children from Lebone, for their enthusiasm and kindness, and for sharing their experiences.
- Gloria Pitso, Emelia Molefi, Mpho Mohobo and Lulu Ngcobo for their assistance and co-operation during the fieldwork.
- The key informants who generously shared their knowledge and views, for their time and willingness to take part in this study.
- My supervisor, Dr Zendré Swanepoel, for her guidance, constant faith in me and support, particularly during the initial stages of the fieldwork.
- Prof Dingie Janse van Rensburg, co-supervisor of this study, for providing me with the opportunity and means to further my academic career, for his guidance, patience, encouragement, constructive criticism and understanding in many respects.
- Prof Anette Wilkinson; Prof Coen Bester, Prof Louis Venter and Prof Willfred Greyling for their interest and backing during this study.
- Prof Anthony Ulyatt for editing the literature review and Mrs Marie-Thérèse Murray for editing the introduction, methodology, results and discussion sections.
- Mrs Sonja Liebenberg and Francois Steyn for their assistance in the technical finishing of this document.
- My colleagues at the Centre for Health Systems Research & Development, for their interest and incredible support during the research.
- Marisa Wilke (Catholic Relief Services Project Manager), for her passion for life, friendship and support, especially during tough times.
- My friends and family, particularly my mother and grandmother, for their interest and belief in me, and for their understanding, having to deal with little time spent together.
- My husband, Cobus, for inspiration and support.
- God, for strength, courage and guidance, and for entrusting the eight children from Lebone to me.

Synopsis

TITLE: Exploring psychological resilience among pre-adolescents orphaned by AIDS: a case study

STUDENT: Anja Pienaar

DEGREE: M Ed. (Specialising in Psychology of Education)

SUPERVISORS: Dr Z. Swanepoel
Prof H.C.J. van Rensburg

KEY WORDS: Psychological resilience; HIV/AIDS, orphans; pre-adolescents; child development, intervention and prevention strategies

Children maturing toward adulthood not only grow physically, but also develop psychologically and in ways that define intellectual, social, spiritual and emotional characteristics. The circumstances or conditions in which this growth takes place can impede or enhance their development. Presently, poor socio-economic circumstances in South Africa are fuelling the Human Immunodeficiency Virus (HIV) and Acquired Immune Deficiency Syndrome (AIDS) epidemic in the country, which is depriving families and communities of the assets and social structures necessary for the healthy development of children. In many instances, HIV/AIDS causes the very conditions that enable the epidemic to thrive. However, some children seem to cope, irrespective of these challenging conditions. They appear to rise above their circumstances and attain outcomes associated with healthy development. In other words, faced with significant stressors or adversity, these children display the ability to be resilient.

With this in mind, research was conducted to identify and explore factors contributing to psychological resilience among children who lost their primary caregivers as a result of AIDS. The research focused on eight pre-adolescents living in a community care facility, Lebone Land in Bloemfontein. Primary data were obtained by means of individual interviews. Research tools that incorporate drawing were used to assist and structure the data collection process. Factors that enable the children to cope with and overcome adversities related to AIDS, as well as the actual adversities pertaining to each child, were identified and explored. In addition, individual semi-structured interviews were conducted with seven key informants involved with the education and care of these children in order to collect complementary data regarding the children's behaviour, prior residence and family characteristics, as well as future prospects.

Data were analysed using the constant comparative method. Results indicated that adversities such as illness, death, poverty and violence were significant among the children in the research group. Common factors that contributed to psychological resilience among the group mainly included morality, social values,

resistance skills, religion and faith. These inner resources generally played an important role in assisting the children with their purpose in life. To this end, constructive use of time, commitment to learning, goal-setting, problem-solving ability and self-efficacy played a fundamental role in attaining their future projections. Therefore, the qualities of optimism, perseverance and hope characterised the children's process of recovery. Strong relational networks of support, particularly friendships with other children from Lebone, also contributed toward developing and sustaining resilience.

Based on these results, it is theorised that the causal conditions leading to psychological resilience include need deprivation with resulting tension, and that these elicit the use of defences, specifically repression as a means of coping with traumatic incidents or adversity. As far as the latter is concerned, psychological resilience entails the constant resolution and mediation of the past, present and future. This process necessitates the development of self-awareness not only to facilitate access to external and internal resources, but also to effectively deal with pain associated with loss. The key determining factor or relational condition thought to influence this process is love. In addition, it is posited that by way of cognitive reframing or "re-authoring" and the configuration of a strong internal locus of control (belief system), children may overcome adversity and lead constructive lives.

The results of this study suggest that programmes aimed at promoting resilience in AIDS orphans should employ a Gestalt therapy approach and incorporate creative and expressive activities. Outcomes of such initiatives should preferably be demonstrated by means of longitudinal research strategies.

Sinopsis

TITEL:	Exploring psychological resilience among pre-adolescents orphaned by AIDS: a case study
STUDENT:	Anja Pienaar
GRAAD:	M Ed. (Psigo-Opvoedkunde)
STUDIELEIERS:	Dr. Z. Swanepoel Prof. H.C.J. van Rensburg

SLEUTELWOORDE: Psigologiese weerbaarheid; MIV/VIGS, weeskinders; preadolossensie; kinderontwikkeling; ingryping-en voorkomingstrategieë.

Met volwassewording groei kinders nie net fisies nie, maar ontwikkel ook psigies en op wyses wat intellektuele, sosiale, geestelike en emosionele eienskappe definieer. Die omstandighede of toestande waarin hierdie groei plaasvind kan hul ontwikkeling strem of bevorder. Swak sosio-ekonomiese omstandighede in Suid-Afrika versnel tans die Menslike Immungebrekvirus (MIV) en die Verworwe Immungebreksindroom (VIGS) epidemie wat gesinne en gemeenskappe van die nodige bates en sosiale strukture vir die gesonde ontwikkeling van kinders ontnem. In baie gevalle veroorsaak MIV/VIGS juis die toestande wat die epidemie laat toeneem. Sommige kinders toon egter die vermoë om hierdie uitdagende toestande te kan hanteer. Dit blyk dat hulle bo hul omstandighede uitstyg en uitkomste wat met gesonde ontwikkeling verband hou, bereik. Met ander woorde, gegewe die stressors of teenslae wat hierdie kinders in die gesig staar, toon hulle psigologiese weerbaarheid.

Op grond van die voorafgaande is navorsing onderneem om die faktore wat tot psigologiese weerbaarheid by VIGS-wese mag lei te identifiseer en te ondersoek. Primêre data is deur middel van individuele onderhoude met agt preadolesse te van 'n gemeenskapversorgingsfasiliteit, Lebone Land in Bloemfontein, verkry. Navorsingsinstrumente wat teken as aktiwiteit insluit is as hulpmiddel gebruik om die dataversamelingsproses te struktureer. Faktore wat kinders in staat stel om teenslae wat met VIGS verband hou te hanteer en die hoof te bied, asook spesifieke teenslae ten opsigte van elke kind, is geïdentifiseer en ondersoek. Bykomend is individuele semi-gestruktureerde onderhoude met sewe sleutelpersone gehou wat by die onderrig en versorging van hierdie kinders betrokke is. Tydens hierdie onderhoude is aanvullende data aangaande die kinders se gedrag, vroeëre verblyf- en gesinseienskappe, en toekomsverwagtinge ingesamel.

Data is deur middel van die konstante vergelykende metode geanaliseer. Die resultate toon dat veral teenslae soos siekte, dood, armoede en geweld onder die kinders in die navorsingsgroep voorgekom het. Algemene faktore wat tot psigologiese weerbaarheid gelei het, het hoofsaaklik moraliteit, sosiale waardes, weerstandsvaardighede, asook godsdienste en geloof ingesluit. Hierdie innerlike hulpbronne het 'n belangrike bydrae tot die verwesenliking van hul lewensdoelstellings gelewer. Ten opsigte hiervan het konstruktiewe tydgebruik, verbintenis tot leer, doelwitstelling, probleemoplossingsvaardighede en selfeffektiwiteit 'n fundamentele rol gespeel ten einde hul toekomsprojeksies te bereik. Optimisme, deurstellingsvermoë en hoop het die kinders se herstelproses gekenmerk. Sterk ondersteuningsnetwerke, veral vriendskappe met ander kinders van Lebone, het ook tot die ontwikkeling en volhoubaarheid van weerbaarheid bygedra.

Op grond van hierdie resultate word geredeneer dat die toestande wat tot psigologiese weerbaarheid lei, behoefte deprivasie en gevolglike spanning behels wat verdedigingsmeganismes ontlok, spesifiek repressie as metode om traumatiese insidente of teenslae te hanteer. In hierdie verband bestaan psigologiese weerbaarheid uit die konstante bemiddeling en oplossing van aspekte rakende die verlede, hede en toekoms. Dié proses noodsaak nie net die ontwikkeling van gesonde selfbewussyn om toegang tot eksterne en interne hulpbronne te fasiliteer nie, maar ook om pyn wat met verlies verband hou effektief te hanteer. Die sleutelfaktor of verhoudingsvoorwaarde wat hierdie proses beïnvloed blyk liefde te wees. Bykomend word aangevoer dat kinders deur middel van kognitiewe herstrukturering of "herskrywing", asook die strukturering van 'n sterk interne lokus van beheer (oortuigings), teenslae kan oorkom en 'n konstruktiewe lewe kan lei.

Die resultate van hierdie studie dui daarop dat programme wat die bevordering van weerbaarheid by VIGS-wese ten doel stel, 'n gestaltherapie-benadering moet volg en kreatiewe en ekspressiewe aktiwiteite insluit. Die uitkomst van sulke inisiatiewe moet verkieslik deur longitudinale navorsingstrategieë aangedui word.

Table of contents

CHAPTER 1: ORIENTATION TO THE STUDY

1.	CONTEXTUALISATION, PROBLEM STATEMENT AND RATIONALE	1
2.	AIMS AND OBJECTIVES OF THE RESEARCH	3
3.	RESEARCH STRATEGY AND METHODOLOGY	4
3.1	Non-empirical investigation (Literature study)	5
3.2	Empirical investigation	6
4.	VALUE OF THE RESEARCH	6
5.	CHAPTER LAYOUT AND PRESENTATION	7
6.	SUMMARY	8

CHAPTER 2: AN INTEGRATIVE UNDERSTANDING OF THE PROCESSES LEADING TO RESILIENCE IN THE DEVELOPING CHILD

1.	INTRODUCTION	9
2.	DEFINITIONS AND DESCRIPTIONS OF RESILIENCE	9
3.	SINGLE-FACETED MODELS OF RESILIENCE	11
3.1	Compensatory model	11
3.2	Challenge model	12
3.3	Protective factor model	13
3.4	Interaction of the three models	14
4.	THE INTEGRATIVE MODEL	15
4.1	Stressors and challenges	16
4.1.1	Adversities	16
4.1.2	Stress	17
4.1.3	Risk	19
4.2	The social context	20
4.3	Person-environment interactional process	24
4.4	Internal self-characteristics	25
4.4.1	Domains of internal resilience factors	26
4.4.1.1	Spiritual or motivational characteristics	27

4.4.1.2	Cognitive competencies	28
4.4.1.3	Behavioural or social competencies	29
4.4.1.4	Emotional stability and emotional management	30
4.4.1.5	Physical well-being and physical competencies	30
4.5	Internal individual resilience factors	31
4.5.1	Paradigm of resilience factors	31
4.6	Resilience processes	33
4.6.1	Resilience as the ability to bounce back	34
4.6.2	Resilience as learning	34
4.6.3	Resilience as reintegration	35
4.7	Positive life outcomes	37
5.	SUMMARY	39

CHAPTER 3: DEVELOPMENTAL ASSETS AND CHILDREN AFFECTED BY HIV/AIDS: THE EXTERNAL AND INTERNAL ENVIRONMENT

1.	INTRODUCTION	42
2.	THE CONCEPT OF DEVELOPMENT	42
2.1	External or situational factors and realities in South Africa	44
2.1.1	Stigma and discrimination	46
2.1.2	Poverty and unemployment	47
2.1.3	Violence, crime, alcohol and drug abuse, and neighbourhood disorganization	47
2.1.4	Multiculturalism	48
2.1.5	Disintegration of family structures	48
2.1.6	Education	49
3.	COPING STRATEGIES, RESOURCES AND PROCESSES	50
3.1	Coping strategies	50
3.2	Sources	51
3.2.1	External sources (Environmental variables)	53
3.2.2	Internal sources (Personal factors)	55
3.2.2.1	Efficacy beliefs	55
3.2.2.2	Symbolizing	60
3.2.2.3	Learning	61
3.3	Processes	64
3.3.1	Cognitive processes	64
3.3.2	Motivational processes	65

3.3.3	Affective processes	65
3.3.4	Selection processes	66
4.	DEVELOPMENTAL PHASES	67
4.1	Forethought phase	71
4.2	Performance control phase	71
4.3	Self-reflection phase	72
5.	SUMMARY	72

CHAPTER 4: RESEARCH METHODOLOGY

1.	INTRODUCTION	74
2.	RESEARCH DESIGN	74
2.1	Research methods	74
2.2	Rationale and purpose of qualitative investigation of psychological resilience among pre-adolescent HIV/AIDS-affected children	76
2.3	The research perspective of this study: Grounded and Living theory	76
2.4	Geographical demarcation and selection of participants	77
2.5	Methods of data collection	78
2.5.1	Biographical questionnaire	79
2.5.2	Communication mapping	79
2.5.3	River of life	79
2.5.4	Happy and sad	80
2.5.5	Rationale for inclusion	80
2.6	Data collection process	81
2.7	Objectivity, validity and reliability	83
2.8	Data presentation and analysis	84
2.9	Ethical considerations	85
3.	SUMMARY	86

CHAPTER 5: RESULTS OF THE EMPIRICAL INVESTIGATION

1.	INTRODUCTION	87
2.	THE RESEARCH CONTEXT - LEBONE LAND	87
3.	DESCRIPTION OF CASES	88

SUBJECT 1: Dikeledi		90
1.	Biographical information	90
2.	Idiographic data	90
2.1	Communication mapping	90
2.2	River of life	91
2.3	Happy and sad	92
3.	Interviews held with key informants	94
3.1	Social worker	94
3.2	Caregivers	95
3.3	Pastor	96
3.4	Teacher	96
4.	Identified categories and themes	97
SUBJECT 2: Khaya		101
1.	Biographical information	101
2.	Idiographic data	101
2.1	Communication mapping	101
2.2	River of life	102
2.3	Happy and sad	103
3.	Interviews held with key informants	104
3.1	Social worker	105
3.2	Caregivers	105
3.3	Pastor	105
3.4	Teacher	106
4.	Identified categories and themes	106
SUBJECT 3: Thato		110
1.	Biographical information	110
2.	Idiographic data	110
2.1	Communication mapping	110
2.2	River of life	111
2.3	Happy and sad	113
3.	Interviews held with key informants	114
3.1	Social worker	114
3.2	Caregivers	115
3.3	Pastor	115
3.4	Teacher	115
4.	Identified categories and themes	115

SUBJECT 4: Lebo		119
1.	Biographical information	119
2.	Idiographic data	119
2.1	Communication mapping	119
2.2	River of life	121
2.3	Happy and sad	123
3.	Interviews held with key informants	125
3.1	Social worker	125
3.2	Caregivers	126
3.3	Pastor	127
3.4	Teacher	127
4.	Identified categories and themes	127
SUBJECT 5: Poelo		132
1.	Biographical information	132
2.	Idiographic data	132
2.1	Communication mapping	132
2.2	River of life	134
2.3	Happy and sad	136
3.	Interviews held with key informants	137
3.1	Social worker	138
3.2	Caregivers	138
3.3	Pastor	139
3.4	Teacher	139
4.	Identified categories and themes	140
SUBJECT 6: Kagiso		143
1.	Biographical information	143
2.	Idiographic data	143
2.1	Communication mapping	143
2.2	River of life	144
2.3	Happy and sad	146
3.	Interviews held with key informants	147
3.1	Social worker	147
3.2	Caregivers	148
3.3	Pastor	149
3.4	Teacher	149

4.	Identified categories and themes	149
SUBJECT 7: Bophelo		153
1.	Biographical information	153
2.	Idiographic data	153
2.1	Communication mapping	153
2.2	River of life	154
2.3	Happy and sad	156
3.	Interviews held with key informants	158
3.1	Social worker	158
3.2	Caregivers	159
3.3	Pastor	159
3.4	Teacher	160
4.	Identified categories and themes	160
SUBJECT 8: Zandi		165
1.	Biographical information	165
2.	Idiographic data	165
2.1	Communication mapping	165
2.2	River of life	169
2.3	Happy and sad	171
3.	Interviews held with key informants	172
3.1	Social worker	172
3.2	Caregivers	173
3.3	Pastor	173
3.4	Teacher	173
4.	Identified categories and themes	174
4.	COMPLEMENTARY INFORMATION OBTAINED FROM KEY INFORMANTS	177
4.1	Social worker	177
4.2	Caregivers	178
4.3	Pastor	179
4.4	Teachers	180
5.	SUMMARY	181

CHAPTER 6: DISCUSSION OF THE RESULTS AND CONCLUSIONS

1.	INTRODUCTION	182
----	--------------	-----

1.1	External realities: stressors and challenges	182
1.1.1	Summary of the results	182
1.1.2	Discussion of the results	191
1.2	External supports or support networks	193
1.2.1	Summary of the results	193
1.2.2	Discussion of the results	194
1.3	Inner strengths	195
1.3.1	Summary of the results	195
1.3.2	Discussion of the results	198
1.4	Interpersonal problem-solving skills	199
1.4.1	Summary of the results	199
1.4.2	Discussion of the results	201
1.5	Complementary responses from key informants regarding external supports, inner strengths, and interpersonal, problem-solving skills	202
1.5.1	Summary of the results	203
1.5.2	Discussion of the results	204
2.	CONCLUSIONS	205
2.1	Conclusions regarding the literature review	205
2.2	Conclusions regarding the research methodology	206
2.3	Conclusions regarding the empirical investigation	206
2.4	Conclusions regarding the limitations of the empirical investigation	208
3.	SUMMARY	209

CHAPTER 7: TOWARDS A LIVING THEORY OF PSYCHOLOGICAL RESILIENCE

1.	INTRODUCTION	210
2.	A LIVING THEORY OF PSYCHOLOGICAL RESILIENCE	210
2.1	Causal conditions	212
2.2	Psychological resilience	218
2.3	Contextual specificity of resiliency processes and action or interaction strategies	221
2.4	Consequences	226
3.	FROM THEORY TO PRACTICE, INTERVENTION OR PREVENTION	227
4.	CONCLUDING REMARKS	229

LIST OF REFERENCES

List of figures

FIGURE 1.1	Circularity of the research process applied to this study	5
FIGURE 2.1	Compensatory model	12
FIGURE 2.2	Challenge model	13
FIGURE 2.3	Protective factor model	14
FIGURE 2.4	Bronfenbrenner's ecological model	21
FIGURE 2.5	Internal self-resilience characteristics	26
FIGURE 2.6	The resilience mandala (a)	32
FIGURE 2.7	The resilience mandala (b)	36
FIGURE 2.8	The integrative model	40
FIGURE 3.1	The environment and development	44
FIGURE 3.2	The impact of HIV/AIDS and resulting external factors and realities on the lives of children and families	45
FIGURE 3.3	Triadic model of reciprocal interactions in human functioning	52
FIGURE 3.4	Reciprocal interactions in human functioning	53
FIGURE 3.5	Self-efficacy and vocabulary of resilience strengths	57
FIGURE 3.6	Developmental processes and key points	63
FIGURE 3.7	The development of personality traits across the life stages	68
FIGURE 3.8	The development of self-regulatory competence	70
FIGURE 3.9	Resilience, self-efficacy and reciprocal determinism	73
FIGURE 4.1	Graphical representation of the focus of the study	78
FIGURE 4.2	The data gathering process pertaining to each case	82
FIGURE 5.1	Dikeledi. <i>Communication mapping</i> (2006). Pen on paper, 58 x 81cm	91
FIGURE 5.2	Dikeledi. <i>River of life</i> (2006). Pen on paper, 58 x 81cm	92
FIGURE 5.3	Dikeledi. <i>Happy and sad</i> (2006). Pen on paper, 58 x 81cm	93
FIGURE 5.4	Khaya. <i>Communication mapping</i> (2006). Pen on paper, 58 x 81cm	102
FIGURE 5.5	Khaya. <i>River of life</i> (2006). Pen on paper, 58 x 81cm	103
FIGURE 5.6	Khaya. <i>Happy and sad</i> (2006). Pen on paper, 58 x 81cm	104
FIGURE 5.7	Thato. <i>Communication mapping</i> (2006). Pen on paper, 58 x 81cm	111
FIGURE 5.8	Thato. <i>River of life</i> (2006). Pen on paper, 58 x 81cm	113
FIGURE 5.9	Thato. <i>Happy and sad</i> (2006). Pen on paper, 58 x 81cm	114
FIGURE 5.10	Lebo. <i>Communication mapping</i> (2006). Pen on paper, 58 x 81cm	121
FIGURE 5.11	Lebo. <i>River of life</i> (2006). Pen on paper, 58 x 81cm	123
FIGURE 5.12	Lebo. <i>Happy and sad</i> (2006). Pen on paper, 58 x 81cm	125
FIGURE 5.13	Poelo. <i>Communication mapping</i> (2006). Pen on paper, 58 x 81cm	134
FIGURE 5.14	Poelo. <i>River of life</i> (2006). Pen on paper, 58 x 81cm	136

FIGURE 5.15	Poelo. <i>Happy and sad</i> (2006). Pen on paper, 58 x 81cm	137
FIGURE 5.16	Kagiso. <i>Communication mapping</i> (2006). Pen on paper, 58 x 81cm	144
FIGURE 5.17	Kagiso. <i>River of life</i> (2006). Pen on paper, 58 x 81cm	146
FIGURE 5.18	Kagiso. <i>Happy and sad</i> (2006). Pen on paper, 58 x 81cm	147
FIGURE 5.19	Bophelo. <i>Communication mapping</i> (2006). Pen on paper, 58 x 81cm	154
FIGURE 5.20	Bophelo. <i>River of life</i> (2006). Pen on paper, 58 x 81cm	156
FIGURE 5.21	Bophelo. <i>Happy and sad</i> (2006). Pen on paper, 58 x 81cm	157
FIGURE 5.22	Zandi. <i>Communication mapping</i> (2006). Pen on paper, 58 x 81cm	168
FIGURE 5.23	Zandi. <i>River of life</i> (2006). Pen on paper, 58 x 81cm	170
FIGURE 5.24	Zandi (left). <i>Preliminary drawing</i> (2006). Pen on paper, 58 x 81cm	172
FIGURE 5.25	Zandi (right). <i>Happy and sad</i> (2006). Pen on paper, 58 x 81cm	172
FIGURE 7.1	Integrative framework of a living theory of psychological resilience among HIV/AIDS-affected pre-adolescents	211
FIGURE 7.2	Maslow's hierarchy of needs	217
FIGURE 7.3	The relational worldview model	222
FIGURE 7.4	Ecological perspective of resilience in children	224

List of tables

TABLE 2.1	Reactions to stress in middle childhood (ages: 5-11)	18
TABLE 2.2	Reactions to stress in early adolescence (ages: 11-14)	18
TABLE 2.3	Social context factors	23
TABLE 2.4	Three categories of resilience	33
TABLE 3.1	Developmental assets framework	43
TABLE 3.2	Resilience and self-efficacy in children	58
TABLE 4.1	A comparison of guidelines between quantitative and qualitative research	75
TABLE 5.1	Identified categories and sub-categories (Subject 1)	98
TABLE 5.2	Responses to stressors or adversities (Subject 1)	99
TABLE 5.3	Identified categories and sub-categories (Subject 2)	107
TABLE 5.4	Responses to stressors or adversities (Subject 2)	108
TABLE 5.5	Identified categories and sub-categories (Subject 3)	116
TABLE 5.6	Responses to stressors or adversities (Subject 3)	117
TABLE 5.7	Identified categories and sub-categories (Subject 4)	128
TABLE 5.8	Responses to stressors or adversities (Subject 4)	129
TABLE 5.9	Identified categories and sub-categories (Subject 5)	140
TABLE 5.10	Responses to stressors or adversities (Subject 5)	141
TABLE 5.11	Identified categories and sub-categories (Subject 6)	150
TABLE 5.12	Responses to stressors or adversities (Subject 6)	151
TABLE 5.13	Identified categories and sub-categories (Subject 7)	161
TABLE 5.14	Responses to stressors or adversities (Subject 7)	162
TABLE 5.15	Identified categories and sub-categories (Subject 8)	174
TABLE 5.16	Responses to stressors or adversities (Subject 8)	175
TABLE 6.1	A summary of external realities (stressors and challenges) communicated by the children and/or key informants	183
TABLE 6.2	A summary of external realities (stressors and challenges) communicated by the key informants	184
TABLE 6.3	A summary of initial responses to common external realities (stressors and challenges)	186
TABLE 6.4	A summary of present responses to common external realities (stressors and challenges)	187
TABLE 6.5	A summary of external supports	194
TABLE 6.6	A summary of inner strengths	196
TABLE 6.7	A summary of interpersonal, problem-solving skills	200

TABLE 6.8	A summary of protective factors	203
TABLE 7.1	Paradigm of resilience	220

List of diagrams

DIAGRAM 6.1	Significance of external realities according to four subcategories, as communicated by the children and/or key informants	184
DIAGRAM 6.2	Significance of external realities according to four subcategories, as communicated by the key informants	185
DIAGRAM 6.3	Significance of interpersonal, problem-solving skills according to eight subcategories	201
DIAGRAM 6.4	The importance of the protective factors according to eight subcategories	204

Appendices

- APPENDIX 1 Biographical questionnaire
- APPENDIX 2 Letter requesting consent (Lebone Land)
- APPENDIX 3 Consent form (Lebone Land)
- APPENDIX 4 Letter requesting consent (Shanon Intermediate School)
- APPENDIX 5 Consent form (Shanon Intermediate School)

Chapter 1

ORIENTATION TO THE STUDY

1. CONTEXTUALISATION, PROBLEM STATEMENT AND RATIONALE

Resilience is a key component in children's ability to cope with and survive adversity (Grotberg, 2003: 1). Therefore, as indicated by Rolf & Johnson (1999: 231-2), promoting resilience is critical as this may contribute to the prevention of negative outcomes for youths challenged by significant stressors such as those posed by the Human Immunodeficiency Virus (HIV) and Acquired Immune Deficiency Syndrome (AIDS) epidemic. The effects of AIDS, a deadly disease caused by HIV, devastate the lives of millions of children, and the anticipated extent of the mounting crisis is enormous. According to *Children on the brink* (2004: 7) and the *Framework for the protection, care and support of orphans and vulnerable children living in a world with HIV and AIDS* (Gulaid, 2004: 5), in 2004, globally, more than 14 million children, under the age of 15 had lost their mother or father or both parents to AIDS. This figure is projected to reach 25 million by 2010. By 2020, 40 million children will have lost their primary caregiver(s) to this fatal virus (*Interagency Coalition on AIDS and Development [ICAD]*, 2002: 1). Southern Africa is the region worst affected by the HIV/AIDS pandemic with the estimated number of orphans under the age of eighteen who have lost one or both parents reaching 5,7 million in 2014 due to this single cause (Abdool Karim, 2005: 31; Abdool Karim, Abdool Karim, & Baxter, 2005: 37; *Children on the brink*, 2002: 7; Dorrington & Johnson, 2001: 1; Tolan, 2005: 71).

The impact of HIV and AIDS on the lives of children is complex in that HIV/AIDS not only affects the well-being and support of children, but also impacts on their rights and level of maturity (Dunn, 2004: 1-6 Bellamy, 2004: 15-6; Felner, 2005: 125; Monson *et al.*, 2006: 10, 21). Deterioration in the well-being of such children starts long before their parent(s) die (Gilborn, Nyonyintono, Kabumbuli & Jagwe-Wadda, 2001: 1; Jackson, 2002: 261-4; Mallmann, 2003: 9). Madlala (2003: 6) reports that "children are acutely distressed as soon as their parents are diagnosed with HIV/AIDS." The ensuing effects of parental illness on the children's lives may intensify vulnerabilities and often restrain their rights, for instance the right to food, health, education, play and recreation (Department of Social Development, 2005a: 6), as they are often exposed to a whole spectrum of adult realities and responsibilities well before they have reached the maturity to deal with them.

These complex realities become even more intricate as they relate to various aspects of the children's lives. By the time children are orphaned, the extended family networks, which traditionally supported vulnerable

members, are often overstretched. Consequently, these orphans are susceptible to and suffer social, economic and psychological disadvantages such as the disintegration of family structure, loss of financial security and safety, to the exclusion from the pleasure and merriment of a normal childhood. Young children are “particularly vulnerable, because they do not have the emotional and physical maturity to address adequately and bear the psychological trauma associated with parental [illness and] loss” (Subbarao & Coury, 2004: 1).

Most of these orphans are thus considered to be at risk of harm. Risk factors range from learning disabilities and school failure to unemployment, exploitation, stigmatisation, (substance) abuse, criminal involvement and psychopathology (Bhengu, 2002: 9; *Children on the brink*, 2004: 15; Mastropieri & Scruggs, 2000: 111-117; Steyn, 2005: 8). Therefore, HIV/AIDS-affected children¹ need psychosocial support (*Children on the brink*, 2004; Department of Social Development, 2005a: 6). Teachers and adult caregivers can play a key role in rendering this support. They can fill not only basic needs, but also further needs, such as to expand the worldview of children, provoke a sense of understanding and direction, and create environments in which children can feel valued as significant contributors. Such caregivers acknowledge the existence of children and their rights, some of which include the right to identity, participation in decisions affecting their lives, education and appropriate alternative care (Department of Social Development, 2005a: 7; Van Dyk, 2005: 275).

Although it is widely accepted that the best models of care and support for OVC are found in children’s communities, for example, at homes in their usual environment, 5% of the world’s AIDS-affected children inevitably end up living on the street, in orphanages, children’s villages, or other group residential facilities (Salaam, 2005: 3). Given the growing number of HIV/AIDS-affected children in critical need of care and institutionalisation as a means of refuge, staff at orphanages “firmly believe that children’s homes have an important role to play in the coming AIDS orphan crisis” (Guest, 2003: 89). However, this form of care could fail to meet children’s emotional and psychological needs, tend to promote dependency, and concomitantly lead to poor developmental outcomes (*Children on the brink*, 2004: 19; Jackson, 2002: 285; Rath & Metcalf, 1945: 169-177). This danger underlines the importance of addressing the psychological dimensions of the children’s lives. This is especially the case, when viewed in terms of the extent of the epidemic and other realities such as the socio-economic problems in South Africa. Since these problems are not readily solved, the realisation of positive developmental outcomes associated with psychological resilience by means of their ability to access their inner resources (and consequently, support from their external environment) is crucial for HIV/AIDS-affected children as it may not only lead to survival, thriving and well-being, but also to academic achievement, the development of independence and autonomy (Mallmann, 2003: 3; Sesma, Mannes & Scales, 2005: 282-290).

¹ HIV/AIDS-affected children are children living in a family where there are, or have been, one or more HIV-infected family members (Mallmann, 2003: 9-16).

For pre-adolescents², this realisation is pertinent as adolescence³ is a period of important developmental change. In addition to the biological events of puberty, enormous social, emotional, and cognitive transitions take place which may hold many difficulties and challenges for children. (Cowie & Smith, 1988: 170-200; Papalia & Olds, 1992: 308-315). Therefore, the attainment, development and sustainment of resilience strengths and assets during pre-adolescence are paramount to facilitate and ensure positive development during adolescence. In light of this, and the fact that although the importance of developmental factors (resilience factors) in adolescent⁴ emotional distress has been generally recognised (Steinberg & Belsky, 1991: 439-440, Watkins, 2002: 115-129), research into the role of the psychological resilience concerning adolescent AIDS orphans within the context of South Africa was found to be limited, such research is crucial. The need for and importance of conducting research in this field is further stressed by critics who warn that relating orphanhood to negative developmental outcomes, “labels orphaned children and youth as delinquents and criminals before the necessary contextual research has been carried out” (Salaam, 2005: 7).

2. AIMS AND OBJECTIVES OF THE RESEARCH

The primary aim of this study is to investigate the factors that play a significant role in establishing and sustaining psychological resilience in pre-adolescent HIV/AIDS-affected children. This will guide theory, and in turn, inform practice, intervention strategies and prevention programmes. To this end, the research also aims, to conduct a thorough literature review and an empirical investigation, and to formulate a substantive theory of psychological resilience in pre-adolescent HIV/AIDS-affected children, living in a community care facility. These aims are accomplished by means of the following objectives:

- define psychological resilience;
- investigate descriptions of psychological resilience;
- investigate models of psychological resilience in children;
- attain a conceptual framework for understanding psychological resilience;
- provide an descriptive overview of psychological resilience in children, based on this framework;
- describe the underlying processes and mechanisms, and child characteristics that facilitate the development of psychological resilience;
- explore theories related to this concept;
- investigate how and what developmental assets and/or resources operate in children’s lives to help them cope amid exposure to adversities;
- study the relationship of these processes and resources in relation to developmental phases;

² Pre-adolescence is defined as a preparatory developmental phase for adolescence. The term pre-adolescence is generally used to refer to children between the ages of ten and twelve years (Staton, 1963: 169), but for the purposes of this study, this demarcation was extended to encompass the whole transition period leading to adolescence, that is from the end of middle childhood to the inception of adolescence. Thus, in this context, the term pre-adolescence is used to refer to the period of children’s development ranging from nine (the onset of pre-adolescence) to thirteen years of age.

³ Adolescence is the term used to describe the developmental transition between childhood and adulthood (Papalia & Olds, 1992: 555).

⁴ An adolescent is a child generally considered between the ages of twelve and twenty-one (Steinberg & Belsky, 1991: 434; Papalia & Olds, 1992: 555).

- explore the external or situational factors and realities faced by HIV/AIDS-affected children, living in South Africa;
- examine the coping strategies used by HIV/AIDS-affected children;
- understand by means of observation, conversation and interview what occurs within the particular research situation;
- construct a research design appropriate and conducive to gathering the necessary empirical data;
- record the experiences of AIDS-orphaned pre-adolescents, living in a community care facility;
- determine the views of key informants such as educators and caregivers regarding the psychological resilience of these children;
- structure the information according to the individual cases studied;
- establish principal categories whereby the obtained information can be analysed, compared, as well as reviewed and interpreted according to the results of the literature review and other relevant sources;
- uncover the relationship between these categories according to a grounded theory coding paradigm⁵;
- reach a conclusive understanding of the psychological resilience in the children selected for this study; and
- propose recommendations and possible strategies or guidelines to foster resilience in children with the intent of informing practice, and prevention and intervention programmes, based on the theory formulated from the results and conclusions of this study.

3. RESEARCH STRATEGY AND METHODOLOGY

Conducting research implies following a systematic process to discover, interpret and revise theories and/or facts “so that those data become meaningful in the total process of discovering new insights into unsolved problems and revealing new meanings” (Leedy, 1985: 4). As shown in Figure 4.1, this process is circular, characterised by the relationship between five main elements guided by research theory (Walliman, 2004: 194).

⁵ The grounded theory coding paradigm comprises of (the relationships among) the following constructs: (1) the causal condition(s), (2) the phenomenon, (3) the context, (4) intervening conditions, (5) action/interaction strategies, and (6) consequences (Kelle, 2005: 5-6 of 17).

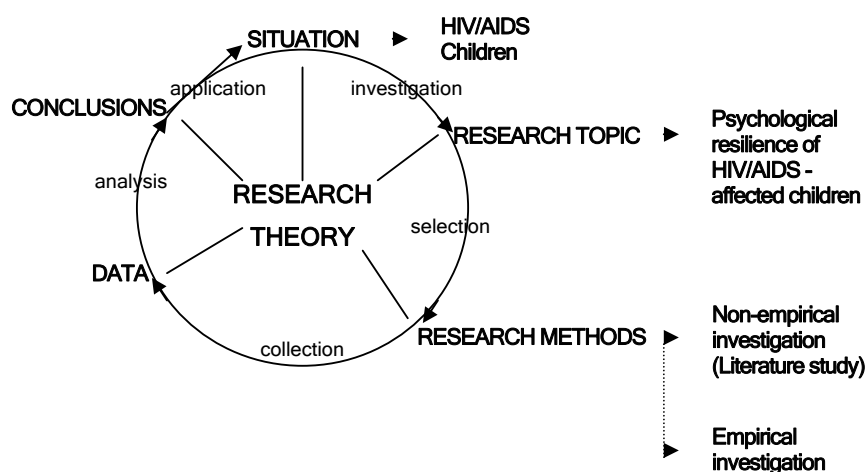

Figure 1.1: Circularity of the research process applied to this study

Source: Adapted from Walliman (2004: 194) and based on Babbie (1998: 105).

In respect of the present research, the first element focuses on the relationship of two guiding areas of interest, in particular HIV/AIDS and children. Further investigation into these two aspects informed the research topic, namely, the psychological resilience of HIV/AIDS-affected children, plus the preliminary research questions, and the aims and objectives for this study. In order to realise these aims and objectives, in other words, to complete the research process or circle (cf. Figure 1.1), two scientific methods are selected and applied to gather information: (1) a non-empirical investigation or literature study, and (2) an empirical investigation. The latter is discussed extensively in Chapter 4. Section 3.2 on the following page briefly describes what this method entails.

3.1 Non-empirical investigation (Literature study)

The non-empirical investigation is a preliminary review of literature gathered from relevant journals such as the *Journal of Community Psychology*, *Educational Psychology in Practice*, and *Psychological Review*, and from books written by well-known authors in the field among others, Brooks, Gamezy, Glantz, Goldstein, Grotberg, Masten, and Johnson. In addition to these scientific sources, information on resilience is gathered from two masters' dissertations (Eberson, 2001; Middel, 2001) and a doctoral thesis (Du Toit, 2005). Due to the number of books available on the subject, the researcher relies, to a large extent, on sources from online databases (internet). Articles from newspapers are reviewed to contextualise and conceptualise the investigation. This review is aimed at a clearer understanding of the nature and meaning of the research problem.

A thorough review of the relevant literature on the topic is done in Chapters 2 and 3.

3.2 Empirical investigation

The purpose of this empirical or qualitative investigation is to generate first-hand knowledge about the psychological resilience of pre-adolescents living in a community care facility. An explorative case study approach is followed. Data are gathered mainly by means of semi-structured interviews held with eight AIDS orphans, as well as with key informants such as caregivers and educators.

Prior to the empirical investigation, visits to various care facilities for HIV/AIDS-affected children such as hospices, affiliated day care centres, as well as a school in the township near Bloemfontein were visited. In the process, eleven preliminary informal interviews were conducted to gather relevant information and explore research possibilities. The findings of these preliminary interviews indicated that HIV/AIDS-related stigma in the community, and in particular among learners were rife. This compromised the identification of possible research participants, and according to the teachers, having to gain parental consent was problematic and would stifle proceedings. Therefore, variables such as accessibility, age, status (meaning HIV/AIDS-affected children), and the number of available participants were used as criteria, in demarcating the research area (i.e. either schools, the community or care facilities where HIV/AIDS-affected children were accommodated). Based on these criteria and the fact that the particular environment or case would require and/or illustrate certain resilience processes, a community care facility was selected in which to conduct the study. All the children were located in one place and it was known that all the children at the facility were affected by HIV/AIDS. At least eight children within the demarcated age category (i.e. the inception of adolescence) participated in this study.

The data gathered during the empirical investigation was analysed and summarised, and reviewed and interpreted in terms of the results of the literature review. Conclusions were drawn and prospective research, practice, prevention and/or intervention strategies were considered. These considerations and recommendations are based on the theory formulated from the results of both the literature study and the empirical investigation. In other words, in order to complete the research circle, it was considered how the results of this study may be applied to the situation of the research participants in order to foster psychological resilience in these children. The research strategy, design and methodology followed in this study, as well as the results and conclusions, are presented in full in Chapters 4, 5, 6 and 7.

4. VALUE OF THE RESEARCH

The importance and value of studying resilience indicates that no child is immune to pressure. Even the best cared for children, who do not face significant adversity or trauma, experience pressures and expectations imposed on them by their environment. Therefore, although the study focuses on the experiences of children

orphaned by AIDS, the information obtained, will expectantly stimulate further research in this field, or be used by other professionals involved in childcare and/or education.

Moreover, the value of the study clearly lies in a statement by Maletela Tuoane at the *Joint Population Conference* held during September 2005, in Bloemfontein: “a better understanding of children’s lives at this time of significant family disruption is critical to efforts aimed at promoting child resiliency in this time of crisis.” In addition, this research could provide valuable information for future interventions targeted at HIV/AIDS-affected children and aid improvement of relevant strategies and approaches that specifically attend to the psychosocial and educational needs of HIV/AIDS-affected children (pre-adolescents) within the specific cultural group and community. As argued in the introduction of this chapter, the worth of resilience research further holds promise for the prevention of poor developmental outcomes for at-risk youth.

The fact that various factors influence the psychological well-being and development of adolescents stresses the importance of identifying protective factors that help adolescents to be more resilient in the face of adversity, such as the loss of a parent due to AIDS. Increased understanding of the use of developmental assets most prominent during the onset of adolescence may enhance conceptualisation of resilience during this transition period. An examination of age- or maturity-related developmental influences may also enhance our understanding of underlying reasons for children’s abilities to cope with the effects of AIDS on their lives, as well as risk and protective factors. In this respect, “continued theory building about individuals with differing risks and assets can allow for better understanding of human developmental processes in differing times, places, and social contexts” (Greene & Conrad, 2002: 41).

5. CHAPTER LAYOUT AND PRESENTATION

Chapter 1 provides a general orientation to and overview of the proposed study. A specific need for, and the importance of research into factors influencing the psychological resilience of children affected by HIV/AIDS, and adolescents in particular, is argued. Attention is focused on the specific research questions elicited by exploration of the research problem, how these research questions will be addressed, in other words, how the research will be conducted, possible contributions of the study, and the value of the research in terms of prevention programmes and further research in the field. An account of the preliminary study is given and the parameters within the research project are drawn.

Chapter 2 provides a literature review. It is aimed at defining the concept of resilience, and investigates various resilience models and related processes that may lead to resilience in children. This chapter comprises of three components, namely, (1) definitions and descriptions of resilience, (2) single-faceted models of resilience and (3) the integrative model (used as a conceptual framework to direct further investigation in keeping with the aim of this chapter).

Chapter 3 is a continuation of the literature review, and focuses specifically on the resilience of children orphaned by AIDS from a developmental perspective. A more in-depth and detailed description is provided

of the underlying child-environment interactive processes and mechanisms that facilitate children's development of resilience.

Chapter 4 explains the methods and procedures followed in the empirical study. This entails a detailed description of the research design employed to conduct the investigation including (1) a general overview of principal research methods, (2) the rationale and purpose of a qualitative investigation of resilience in pre-adolescent HIV/AIDS-affected children, and (3) the research perspective of this study. Subsequently, descriptions of the (4) the geographical demarcation of the study and the selection of participants, (5) the methods of data collection, (6) the data collection process, (7) considerations relating to the objectivity, validity and reliability of the research, (8) data presentation and analysis, as well as (9) ethical considerations are presented.

Chapter 5 presents the results of the empirical study in three sections. The first section briefly describes and gives a historical overview of the research setting, Lebone Land, to contextualise the results. Section two reports on the data obtained in the individual cases. The presentation of each case is followed by an analysis and discussion of the data pertaining to that particular subject (case). The final section presents complementary data collected from various key informants.

Chapter 6 entails a summary, discussion and interpretation of all the gathered information pulled together in a coherent report. Subsequently, conclusions regarding the literature review, the research methodology and the empirical investigation are presented as a prelude to the conclusions presented in Chapter 7.

Chapter 7 is a concluding chapter. It formulates a living theory of psychological resilience in HIV/AIDS-affected children. This theory is presented according to five interrelated constructs, namely, (1) causal conditions, (2) the studied phenomenon - psychological resilience, (3) the context, (4) action/interaction strategies, and (5) consequences. Strategies or guidelines, based on this living theory, which might have some promise for practical application, are suggested and recommendations for future research are made.

6. SUMMARY

Children challenged by the effects of the HIV/AIDS epidemic need support. Governments, communities, families and schools may render this support. Yet, considering the extent of the epidemic and the complexity of factors that affect the lives of these children, this dilemma is not readily solved. Many children affected by HIV/AIDS are institutionalised. Although these institutions or facilities may provide support in terms of basic needs, such as clothing, water, food, and shelter, these forms of care may still fail to meet the children's emotional and psychological needs, which may lead to poor developmental outcomes and reciprocally, influence their ability to cope with and conquer adversity. Therefore, addressing the psychological aspect of their lives, in particular, the psychological resilience of children is critical as this may lead to positive developmental outcomes and survival. The following chapters attempt to provide answers to problems and questions highlighted in this chapter and subsequent chapters, and to elucidate related issues and concepts.

Chapter 2

AN INTEGRATIVE UNDERSTANDING OF PROCESSES LEADING TO RESILIENCE IN CHILDREN

1. INTRODUCTION

Until the 1970s, social science researchers focused primarily on the harmful effects of factors such as poverty, racism, abuse, neglect, violence, and illness on individuals' lives (Ah Shene, 1999: 2 of 9; Brentro & Larson, 2004:195-6, Greenglass & Uskul, 2005: 269; Wolin, 2002: 10). The fatalistic model that emerged, as Ah Shene (1999: 2 of 9) explains, assumes that a troubled childhood leads inevitably to a troubled adulthood. What this model fails to explain is the fact that some children remain well-adjusted under adverse conditions, or stumble early in life, then turn their lives around later. Studies of resilience have shown precisely this: children have the ability to rise above life's adversities and achieve developmental goals (Dugan & Coles, 1989; Greene, 2002: 4-8).

Resilience theory describes resilience as a process (Glantz & Sloboda, 1999: 116; Kaplan, 1999: 63; Luthar, Cicchetti & Becker, 2000: 543). This process "involves a balancing of protective factors against risk factors, and the gradual accumulation of emotional strength as children respond successfully to challenges in their families, schools and communities" (Ah Shene, 1999: 3 of 9). Hence, resilience - a process in itself - comprises various related processes and constructs, signifying the interrelationship between children and their environment.

This chapter examines the concept of resilience, with specific focus on children. First, an analysis of definitions and descriptions of resilience are presented. Secondly, models of resilience are investigated to gain insight into its fundamental processes and mechanisms. Thirdly, the integrative model proposed by Kumpfer (1999: 183) is used as a framework to explain the contextual risk and protective factors, intervening processes, and characteristics of the resilient child.

2. DEFINITIONS AND DESCRIPTIONS OF RESILIENCE

Zimmerman & Arunkumar (1994: 5) argue that a single definition may not adequately capture the complex meaning of resilience. Therefore, various definitions of resilience are considered to reach a conclusive idea of what the term entails. An overview of literature on studies of resilience provided the following definitions:

The *American Psychological Association* (Comas-Diaz, Luthar, Maddi, O'Neill, Saakvitne, Tedeschi, 2004: 1 of 1) defines resilience as

the process of adapting well in the face of adversity, trauma, tragedy, threats, or even significant sources of stress – such as family and relationship problems, serious health problems, or workplace and financial stressors. It means "bouncing back" from difficult experiences.

Masten & Coatsworth (cited in Middel, 2001: 12) define resilience as "manifested competence in the context of significant challenges to adaptation or development." More specifically, Grotberg (2003: 1) refers to resilience as "the human capacity to deal with, overcome, learn from or even be transformed by the inevitable adversities of life." According to Staudiger, Marsiske & Baltes (1993: 541), the term resilience refers both to "the maintenance of healthy development despite the presence of threat and to the recovery from trauma."

Emphasizing the positive side of resilience, it is defined as

the capacity to rise above adversity – sometimes the terrible adversity of outright violence, molestation or war – and forge lasting strengths in the struggle. It is the means by which children of troubled families are not immobilized by hardship but rebound from it, learn to protect themselves and emerge as strong adults, able to lead gratifying lives (Wolin, cited in Marano, 2003: 2 of 4).

Other authors refer to resilience as "a pattern of positive adaptation in the context of past or present adversity" (Wright & Masten, 2005: 19); "a psychological quality that allows a person to cope with, and respond effectively to, life stressors" (Neill & Dias, 2001: 5); or "that inbred, evolutionary ability to live and grow and love against all odds" (Seligman, cited in Brooks & Goldstein, 2003: xv).

Wolin & Wolin, (1999c: 1 of 1) make the important remark that resilience is the process of *persisting* in the face of adversity and of struggling with hardship. "That process progresses by accumulating small successes that occur side by side with failures, setbacks, and disappointments" (Wolin & Wolin, 1999c: 1 of 1). Hence, resilience does not manifest itself as an once off episode, but is part of an ongoing, meaningful process.

These definitions suggest clearly that resilience is a process which is mobilized in the face of adversity and culminates in a positive outcome. The key elements outlined are:

- resilience is a *human capacity*
- resilience is a *psychological quality*
- resilience is a *developmental process* (of successful adaptation, protection, persistence, struggle, learning, "bouncing back", forging strengths; recovery and transformation)
- resilience is the *maintenance of this healthy development*
- resilience is *mobilized in the face of adversity* (such as trauma, tragedy, threats, stress, family and relationship problems, serious health problems, poverty, and violence)
- resilience is defined in terms of *outcomes*, that is manifested competence

With regard to outcomes, Zimmerman & Arunkumar (1994: 4) and Kaplan (1999: 20) point out that resilience and outcome are causally connected. Resilience, they explain, may be thought of as the functional equivalent of outcomes. This means that resilience is defined in terms having benign or less malignant outcomes in the face of stressors. Alternatively, resilience may be thought of as the cause of outcomes, which points to resilience as the general construct that reflects specific characteristics and the mechanisms through which they operate that moderate the relationships between risk factors and outcome variables. Consistent with this viewpoint, Lai (2000: 39) mentions, “ultimately, the developmental outcome is a result of the interaction between risk and protective factors.” This interaction has been conceptualised in three models: the compensatory, challenge, and protective factor models.

3. SINGLE-FACETED MODELS OF RESILIENCE

I refer to the following three models as single-faceted models as they represent *components* of resilience, or mechanisms and processes that may be responsible for a resilient response in children, namely: compensation, challenge, and protection. These components or factors will be discussed in relation to outcome.

3.1 Compensatory model

A compensatory factor is a variable that neutralizes exposure to risk (O’Leary, 1998: 2 of 19). The compensatory model focuses on individual characteristics, for example, an active approach to solving life’s problems, or external sources of support such as a family network, to counteract stressful or adverse events. A risk factor, in turn, refers to a factor that limits the likelihood of successful development (Blum, n.d.: 3 of 20). It can also refer to “a measurable characteristic in a group of individuals or their situation that predicts negative outcome on a specific outcome criterion [e.g. mental health]” (Wright & Masten, 2005: 19). Measurable characteristics can be premature birth, parental divorce, poverty, or parental mental illness. In other words, compensatory factors do not eliminate risk, but may initially lower risk or ameliorate risk throughout development. Hence, compensatory factors have a direct and independent influence on the outcome of interest and contribute cumulatively to the prediction of outcome (Bender & Castro, 2004: 73-4; Cook & Du Toit, n.d.: 4 of 20; Lai, 2000: 38; O’Leary, 1998: 2 of 19). Figure 2.1 illustrates this concept of compensation.

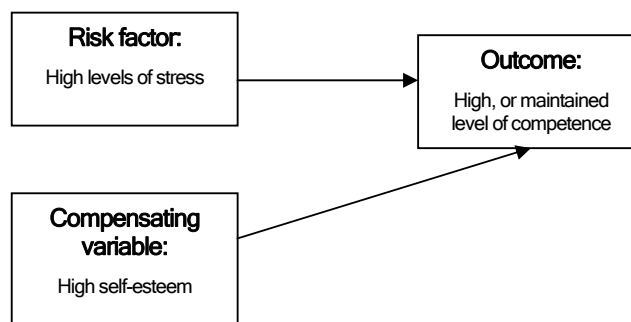

Figure 2.1: Compensatory model

Source: Adapted from Arunkumar & Zimmerman (1994: 5).

Zimmerman & Arunkumar (1994: 5) explain that stress (risk factor) and self-esteem (compensatory factor) are seen to combine accretively in the prediction of competence (outcome). Thus, when one of the independent variables, stress or self-esteem, remains constant, competence changes with changing levels of the other independent variable. Higher levels of self-esteem, compensate for higher levels of stress exposure; thus, children with high self-esteem maintain a level of competence comparable to children who have less self-esteem but also less stress exposure.

3.2 Challenge model

Bender & Castro (2004: 74) state that in the challenge model, illustrated in Figure 2.2, previously stressful events can potentially enhance competence. This implies that if the challenge is met successfully, it helps prepare the child for the next difficulty. Rutter (cited in O’Leary, 1998: 2 of 19) referred to this process as “stealing” or “inoculating.” For example, a child (14 years old) is identified as an at-risk learner; he is disruptive in class, frequently late or absent from school, his academic skills are two years below grade level, he lives in a single-parent household (with his mother), his mother was a teenager when he was born and she is now addicted to illegal drugs. He is challenged by these troubles to experiment and to respond actively and creatively. He responds by taking care of both his brother and mother. As his mother resists treatment, he escorts her to the drug treatment centre, and goes along to the supermarket to make sure that she buys food instead of spending her money on drugs. He cooks for his brother when there is enough food and makes sure that he attends school, even though he himself often does not. Thus, he uses his strengths, such as practical, emotional and moral intelligence to adapt to, and deal with, his situation. Repeated over time, these responses may become lasting inner strengths. The challenge model does not negate the fact that hardship may cause harm, but acknowledges that hardship or adversities may include strengths as well (Wolin, 2002: 11).

Zimmerman & Arunkumar (1994: 6) mention that, if efforts to meet a challenge are not successfully met, the individual may become increasingly vulnerable to risk. For example, given the situation of the child mentioned in the previous paragraph, he could have responded by dropping out of school and staying at home or running away from home and ending up on the streets. This could have placed him at further risk of drug abuse, becoming involved in criminal behaviour, and being imprisoned. Figure 2.2 illustrates the challenge process:

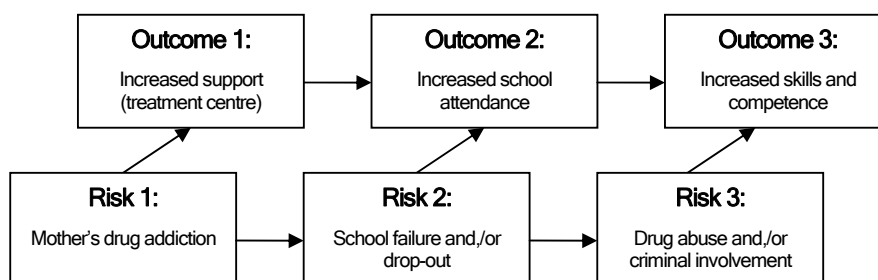

Figure 2.2: Challenge model

Source: Adapted from Arunkumar & Zimmerman (1994: 6).

Viewed in terms of development, optimal levels of stress are required to strengthen adaptation and competence as a child meets a given challenge. Too little stress is not challenging enough and excessive levels of stress may result in dysfunction or maladaptive behaviour (O'Leary, 1998: 2 of 19; Zimmerman & Arunkumar, 1994: 6).

3.3 Protective factor model

According to O'Leary (1998: 3 of 19), the protective model differs from the compensatory and challenge models in that it operates *indirectly* to influence outcomes. Zimmerman & Arunkumar (1994: 6), however, state that a protective factor may have a direct effect on an outcome. For example, healthy family relationships (protective factor) may lower a child's probability of alcohol and drug abuse indirectly. Then again, attendance of an prevention programme, specifically aimed at alcohol and drug abuse may have a more direct effect.

Two mechanisms that seek to explain how protective effects may function are: 1) a risk/protective mechanism, which functions to mitigate the negative effects of a risk factor (Figure 2.3 A); and 2) a protective/protective mechanism, which works by enhancing the protective effects of variables found to decrease the probability of negative outcomes (Figure 2.3 B) (Zimmerman & Arunkumar, 1994: 6-7).

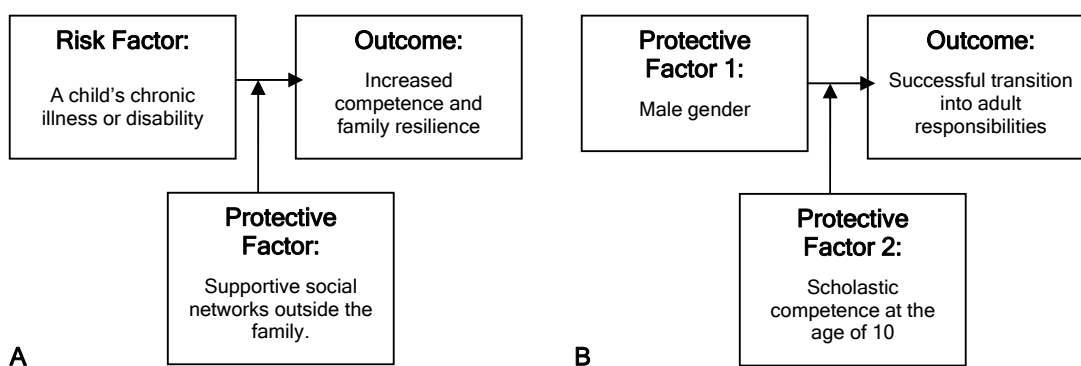

Figure 2.3: Protective factor model

Source: Adapted from Zimmerman & Arunkumar (1994: 7).

Risk/protective mechanism. Research indicates, for example, that families who are pro-active in maintaining their social networks are better able to adapt to the stressors related to a child's chronic illness or disability within the family. Through interactions with others who have children with similar conditions, families learn new skills and find resources for managing their child's condition in a variety of settings. Thus, support networks outside the family decrease social isolation and provide emotional, informational, and practical resources for families that contribute to family resilience (Sheridan, Eagle & Dowd, 2005: 172, Garwick & Millar, 1995: 21). Hence, a protective factor interacts with a risk factor to moderate the effect of exposure to risk, and acts as a catalyst by modifying the response to risk, to reduce the probability of a negative outcome (Blum, n.d.: 4 of 20; Cook & Du Toit, n.d.: 4 of 20; O'Leary, 1998: 2 of 19; Zimmerman & Arunkumar, 1994: 8).

Protective/protective mechanism. Smith & Werner (cited in Zimmerman & Arunkumar, 1994: 3) found that scholastic competence at the age of 10 was more strongly associated with successful transition into adult responsibilities for men than for woman.

3.4 Interaction of the three models

The following example, however, indicates that, although the three models mentioned before differ, they are not mutually exclusive. Zimmerman & Arunkumar (1994: 8) provide the example of a boy, called John, who succeeds in avoiding the risks associated with his life, because a positive male role model compensated for his father's absence because of the minor role he played in John's life after the divorce from his wife (compensatory model), and because the support John received from his network of drug-free and non-violent friends helped to protect him from the risks associated with growing up in a poor and high-crime neighbourhood (protective factor model). Successfully overcoming the experience of stress and hurt of his older sibling's troubles (i.e. dropping out of school, alcohol abuse, unemployment and crime) may have

made him able to cope better with the new stress of added family responsibilities in his brother's absence after being imprisoned (challenge model). Thus, positive factors in children's lives may act to compensate for some risks while interacting with others to reduce negative outcomes. Zimmerman & Arunkumar (1994: 8) argue further that "some risk factors that ordinarily might be thought detrimental may provide a manageable level of stress so that future exposure to risk is less debilitating." Therefore, the child's capacity to deal with ever more intense stress is strengthened as the initial stress, in effect, becomes a resource for growth or development.

4. THE INTEGRATIVE MODEL

The rationale for the use of an integrative model in an attempt to understand the construct of resilience is thus based on the following arguments. Masten & Coatsworth (cited in Goldstein & Brooks, 2005: 11) formulate this principle well: "Given the complexity of the human species and the culture we have created, there is a need to view the accomplishment of wellness and resilience from a multifaceted developmental and dynamic perspective." Bronfenbrenner & Crouter (cited in Kumpfer, 1999: 183) envisage an integrative model when recommending "the use of social ecology models or person-process-context models to study the relationship of contextual risk and protective factors, intervening processes and individual characteristics."

Rather than focusing on various resilience factors or processes as many different constructs of resilience do, the integrative model proposed by Kumpfer (1999: 183) incorporates these aspects, found in the compensatory, challenge, or protective models. This theoretical model will therefore be applied in this study as a framework to investigate the relationship of the salient resilience factors, related processes, constructs, and outcomes from a multi-faceted developmental and dynamic perspective to reach an understanding of the concept of resilience.

Six major constructs, also considered as predictors of resilience, are specified. These constructs are divided into (a) four domains of influence and (b) two points of transactional processes between domains, namely:

- a) The stressor or challenge;
the social context;
the individual characteristics; and
the outcome.
- b) The person-environment interactional process (confluence between the social context and the child);
and
the individual and choice of outcomes.

4.1 Stressors or challenges

Resilience can be shown only as and when the child experiences some kind of adversity (stressor) or challenge. The initiating event in the resilience framework - stressors and challenges - refer to incoming stimuli that activate the resilience process by creating a “disruption or disequilibrium in homeostasis” in the child or social unit, for example, the family or community (Blum, n.d.: 3 of 20; Kumpfer, 1999: 183, 189; Middel, 2001: 112).

This disruption or disequilibrium is not necessarily predictive of a negative outcome. Smith & Carlson (1997: 235) argue correctly that “not all youth subjected to high levels of stressors or (risk factors) experience poor outcomes.” Challenges foster healthy development in children as they face new stressors. A child may meet a challenge by accepting to enter a marathon. In this case, the child can consciously select anticipated stressors. Stressors related to unanticipated negative experiences or adversities (e.g. neglect), on the other hand, obviously do not involve choice on the part of the child. Nevertheless, children can also learn valuable lessons in coping successfully with these negative life events. Resilient children develop the ability to solve problems and have confidence in their decisions. They view mistakes or obstacles as challenges rather than stressors (Brooks & Goldstein, 2003: 6). Possible adversities that children may face are given in the following section.

4.1.1 Adversities

Dent & Cameron (2003: 4) identify adverse factors (adversities) as “those life events and circumstances that threaten or challenge healthy development.” More specifically, Wright & Masten (2005: 19) define adversities as “environmental conditions that interfere with or threaten the accomplishment of age appropriate developmental tasks.” According to Dent & Cameron (2003: 4), Winslow, Sandler, & Wolnick (2005: 338) and Grotberg (2003: 2), these conditions or factors can be grouped as:

- **Adversities experienced within the individual:** Examples include experiences such as illnesses, injuries, or abuse. These experiences compromise children’s relations with their environments.
- **Adversities experienced within the family:** Examples include maternal depression, marital discord or domestic violence, experience of abuse, including sexual abuse, neglect and separation or loss through bereavement, divorce or separation from a significant person in the child’s life, illness of a parent or sibling, poverty, moving, accidents causing personal injury, abandonment, suicide, remarriage, homelessness, poor health and hospitalization, fires causing personal injury, forced repatriation of family, disabled family member, and parent’s loss of job or income.
- **Adversities experienced outside the family or community organizational domains:** Examples include robberies, war, fire, earthquake, car accident, adverse economic conditions, illegal refugee status, migrant status, property damage, storms, floods, cold, political upheaval, famine, abuse by a non-relative, murders in the neighbourhood, unstable government, or drought.

Grotberg (2003: 2) suggests that being able to identify an adversity is usually the first step for a child in learning how to deal with it. Similarly, Gamezy (1991: 456) argues:

[p]erhaps a portion of resilient behaviour is the evaluative awareness of a difficult reality combined with a commitment to struggle, to conquer the obstacle, and to achieve one's goals despite the negative circumstances to which one has been exposed, which were and remain evocative of sadness.

In essence though, a child's vulnerability to adversity, or ability to overcome anxiety, challenges, stress or unfamiliarity determines his or her self-perception, how he or she interacts with others, and how he or she addresses adversities (Goldstein & Brooks, 2005: 11; Grotberg, 1995: 4).

4.1.2 Stress

Children facing adversity (e.g. the loss of a parent, divorce of parents or abuse), often feel lonely, fearful, vulnerable, and experience stress (Grotberg 1995: 9; Smith & Carlson, 1997: 232). Smith & Carlson (1997: 232) identify two types of stressors:

- **Acute stressors:** include major life events, both ordinary, that is events experienced by most children, for example, entering a new school, and unusual or exceptional events, such as experiencing a natural disaster or illness of a parent; as well as daily hassles such as arguing with parents (Kanner, Coyne, Schaefer & Lazarus, 1981: 1-37).
- **Chronic stressors:** are ongoing adverse events of mental retardation, deprivation, abuse, homelessness, or neglect.

These examples make it clear that stressors, in the same way as risk factors and adversities, can originate both from within the individual and from the environment. Masten (2005: 1 of 6) observes that "children are more typically at-risk due to multiple adversities extending over time, sometimes very long periods of their lives." The death of a parent due to illness caused by AIDS, for instance, is not a single adversity, but often a lengthy process of multiple stressors and changes occurring before, during, and after the death itself. For the child, this process may include having to face stressors such as poverty, the parent's illness itself, the parent's loss of job and/or income, death, loss of a primary caregiver, and homelessness.

De Bord (n.d.: 4 of 6) suggests that the most frequent indicator that children are stressed is change in behaviours (cf. Table 2.1 and 2.2). This may take the form of regression of behaviours, meaning the child reverts to behaviours seen in earlier phases of development, for example, thumb sucking (Biehler, 1981: 114). Stress reactions by children may also include sleep disorders; belief that another bad event will occur; conduct disturbances, such as aggressive, anti-social or delinquent behaviour; persistent thoughts of trauma; hyper alertness; avoidance of stimulus or similar events (e.g. swimming, baths; travelling; moving); regression; dependent behaviours; time distortion; obsession about an event; feeling vulnerable; or

excessive attachment behaviours (Bee, 1989: 523; De Bord, n.d.: 1-2 of 6). Anthony (cited in Bee, 1989: 525) specifies that “a behaviour problem emerges only when there is some accumulation of risks or stresses above the threshold that the child can handle.” Hence, reactions to stress also differ according to age group and level of development. For example, Table 2.1 and 2.2 indicate different reactions to stress observed in children during middle childhood and early adolescence.

TABLE 2.1: Reactions to stress in middle childhood (ages: 5-11)	
Normal reactions to stress	Abnormal reactions to stress
<ul style="list-style-type: none"> • irritability • whining • clinging • aggression, question authority, try new behaviours for 'fit' • overt competition with siblings for parents' attention • school avoidance • nightmares, fear of dark • withdrawal from peers • loss of interest/ concentration in school 	<ul style="list-style-type: none"> • marked regressive behaviours • sleep problems • weather fears • headache, nausea, visual or hearing problems • irrational fears • refusal to go to school, distractibility, fighting • poor performance

Source: Adapted from De Bord (2005: 5 of 6).

TABLE 2.2: Reactions to stress in early adolescence (ages: 11-14)		
Normal reactions to stress	Abnormal reactions to stress	Severe reactions to stress (consider referral for professional assistance)
<ul style="list-style-type: none"> • sleep disturbance • appetite disturbance • rebellion in the home or refusal to do chores • physical problems (skin, bowel, aches and pains) 	<ul style="list-style-type: none"> • withdrawal, isolation • depression, sadness suicidal ideation • aggressive behaviours • depression 	<ul style="list-style-type: none"> • disoriented, has memory gaps • severely depressed, withdrawn • substance abuser • unable to care for self (eat, drink, bath)

Source: Adapted from De Bord (2005: 5 of 6).

In every developmental level, the child's perception of an event is an important mediator of how stressors will be experienced and handled. It will also determine whether stress will lead to negative outcomes (Smith & Carlson, 1997: 234-5). Some life events (parental divorce, neglect, or parental conflict) have the potential to ignite both positive and negative implications for the child. The child may, for instance, benefit from having less contact with an abusive father. However, the negative implications of growing up in a broken home without the presence of a father figure have to be overcome to ensure positive life adaptations. To reiterate, this notion underlines the principles of the challenge model referred to in 3.2. which holds that optimal levels

of stress experienced by children may foster healthy development. But levels of stress that are too high may render the child helpless and increasingly at risk for negative developmental outcomes (Haan, 1989: 27) such as the behaviour problems (cf. Table 2.1 and 2.2). For a child to handle temporary stresses without developing serious behaviour problems, Bee (1989: 527) argues that a secure attachment to at least one person seems fundamental. This brings the protective factor model into play. The child's experience and evaluation of a situation may therefore influence resilience.

4.1.3 Risk

Both stressors and risk factors have the potential to threaten children's well-being (Carlson & Smith, 1997: 235), and so influence developmental outcomes. A risk factor (e.g. drug abuse) increases the probability of poor outcomes, but a stressor (e.g. a high crime neighbourhood) may or may not lead to negative outcomes.

Smokowski (1998: 338) argues that there are several important mechanisms through which risk can be transmitted. Firstly, *risk traits* or individual predispositions, such as temperament traits, "those inborn qualities that unfold as children begin to interact with the world" (Brooks & Goldstein, 2003: 116), or a family history of depression heighten vulnerability to negative outcomes. Secondly, *contextual effects*, in turn, may be direct, for example, inadequate parenting, or indirect such as neighbourhood poverty.

Direct and indirect effects are defined by Wright & Masten (2005: 19) as *proximal risk*, meaning risk factors experienced directly by the child (further examples include, witnessing violence or associating with delinquent peers); and *distal risk*, that is "risk arising from a child's ecological context but mediated through more proximal processes" (e.g. high community crime rate or inaccessible health care).

Kumpfer (1999: 190) mentions the following critical dimensions in defining risk, namely:

- The child's actual experience of risk factors
- The perception or attribution of risk or threat by a child
- The degree of direct and indirect effects on the child, because of proximal or distal status in a chain of causal variables
- The degree of transactional buffering by child or a caring other
- The balance of the accumulation of risk and protective factors
- The presence of salient or powerful protective factors (e.g. supportive home life)
- The age, developmental tasks, cultures, geographical locations, and historical periods

Smokowski (1998: 338) explains that links between different risk factors (such as poverty, parental unemployment, single-parent households, high parental stress, and lower educational attainment) often occur together and are referred to as *risk chains*. This accumulation of risk increases the probability of resultant disorder in the child's life and may have strong deleterious effects on the child's development.

Hence, Smokowski (1998: 338) states that “outcomes generally worsen as risk factors pile up in children's lives, and, concomitantly, resilience becomes less common.” The adaptive equivalent of risk chains is chains of factors that promote positive outcomes, referred to by Smokowski as *resilience strings*, comparable to the protective/protective mechanism described in sub-section 3.3. Wright & Masten (2005: 19) use the term “cumulative protection” to refer to the presence of multiple protective factors in an individual's life. For a child living in a poor neighbourhood, for instance, protective factors may include a warm, attentive parent, a safe home, a supportive school teacher, and an active church.

It should be emphasized: “it is important to recognize that risk factors are only indicators for the potential of problem occurrence” (*The Resilience Model*, n.d.: 2 of 4). Knowledge of these indicators may be useful, however, to aid prevention and intervention programmes. Focus on risk alone may pose problems. Constantine, Benard & Diaz (1999: 3) and Stein (2003: 4-6) warn that a focus on risk factors often leads to the identification, labelling, and stigmatizing of children, their families, and their communities. It should be kept in mind that resilient children, as noted by Constantine *et al.* (1999: 3) and the *Resilience model of substance abuse prevention* (n.d.: 1-2 of 4), are able to defy the odds and achieve competence, confidence, and health in adulthood. Further mentioned complication resulting from too keen a focus on risk factors are:

- The vision of teachers, parents, and other helpers in seeing assets or strengths that all young people have is often obscured.
- Teachers, parents, and other helpers may be left feeling hopeless and helpless. These attitudes can lead to a vicious self-fulfilling prophecy when communicated to children.
- Identification of risk factors in problem behaviour does not inform adult helpers as to what does work, and what they can do to prevent these problems.

It is important, therefore to recognize the value of resilience research. This approach pays more attention to human strengths like hope, courage, friendship, and kindness (Brentro & Larson, 2004: 195) to counteract adversities.

4.2 The social context

The social context includes “the balance and interaction of salient risk and protective factors and processes in the individual child's external environment in critical domains of influence” (Kumpfer, 1999: 183). The family, community, culture, school, and peer group are considered as critical domains of influence. Bronfenbrenner organizes these domains of influence as follows (Papalia & Olds, 1993: 14):

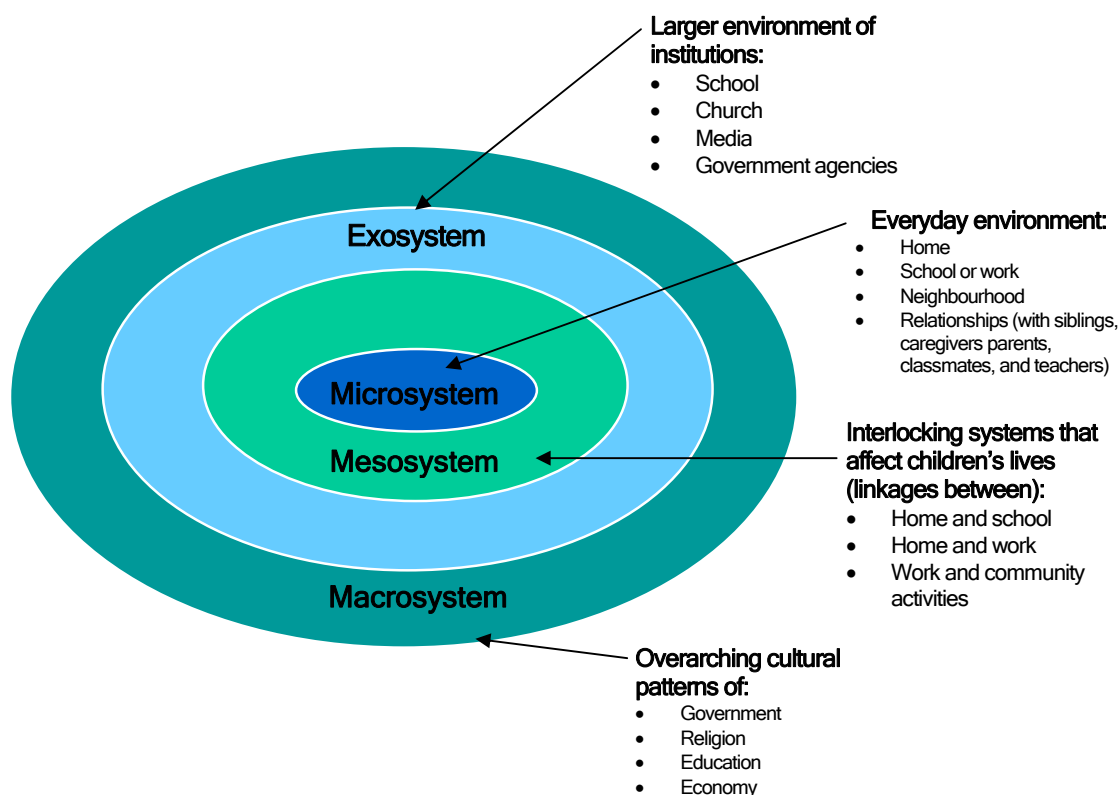

Figure 2.4: Bronfenbrenner's ecological model

Source: Based on Papalia & Olds (1993: 14).

According to this model, children are significantly affected or influenced by interactions among a number of overlapping ecosystems. At the centre of the model is the child. *Microsystems* (family, peer group, classroom, neighbourhood, or a church) are the systems that intimately and immediately shape human development. Interactions among the microsystems take place through the *mesosystem*, for example when parents and teachers co-ordinate their efforts to educate the child. Surrounding the mesosystems is the *exosystem*. This layer or system includes all the external networks (community structures and local educational, medical, employment, and communications systems) that influence the microsystems. [According to this model, the church features as part of both the microsystem and exosystem. This viewpoint will be explored further during the empirical investigation and reported on in Chapter 6]. The *macrosystem* (cultural values, political philosophies, economic patterns, and social conditions) influences all the other systems. Viewed as a whole, these systems are termed as the social context (Cowie & Smith, 1988: 8-10; Greene, 2002: 18; Killian, 2004: 2 of 15; Papalia & Olds, 1993: 14).

The question, however, inevitably arises: Are children a product of an innate *nature* (own biology) or of *nurture* (their environment)? Papalia & Olds (1992: 61) argue that both biology and the environment play a

significant role. Steinberg & Meyer (1995: 7), for instance, explain that, as infants, resilient children show personality traits that are partly a product of their inborn temperaments. In turn, these positive and protective attributes tend to encourage certain learning experiences, for example, through positive peer interaction that enable these children to deal effectively with stress. Most resilient children are cheerful, outgoing and sociable, and they may also use these traits to form close relationships with adults which, in turn, can provide the emotional support needed to help deal successfully with stress.

According to Kumpfer (1999: 190), influences within the social context can thus help the child through psychosocial facilitation processes which reside in the three protective factor clusters of caring relationships, high expectations, and meaningful participation (Constantine *et al.*, 1999: 7). These domains change with age and are specific to culture, geographical location, and historical period (Grotberg, 2003: 151; Kumpfer, 1999: 183, 190).

Hence, the social context within which a child develops is influential on risk and resilience processes (Kumpfer, 1999: 189). The example given by Zimmerman & Arunkumar (1994: 8) referred to in sub-section 3.4, indicates that, when acute or chronic stressors occur, the social context can buffer or exacerbate the negative impact on the child. Table 2.3 summarizes examples of social context factors that can have a positive or negative impact on the child.

TABLE 2.3: Social context factors

Risk factors or stressors	Protective factors (which buffer against the negative impact of environmental risk factors on children's lives)
<ul style="list-style-type: none"> • Anti-social values: For example, dishonesty, violence, or low morality. • Abusing parents: Maltreatment of children by parents involving physical or psychological injury may lead to delays in speech, aggression, delinquency, or problems with school achievement. • Poverty: Research shows that poor children may, develop behaviour problems and learning disabilities for example. • Family dysfunction: A family is dysfunctional to the extent that it does not provide a healthy environment for its members. Four kinds of dysfunctional family systems have been identified, namely: The alcoholic or chemically dependent family; emotionally or psychologically disturbed family; physically or sexually abusive family; and the fundamentalistic or rigidly dogmatic family. Dysfunctional families are shame-based systems characterized by rigid rules, poor communication, inconsistency and unpredictability. Children from these families often experience emotional instability, depression, and anxiety. They are more likely to develop eating disorders (anorexia nervosa or bulimia), to attempt suicide, and are prone to alcohol or chemical dependence. • Ongoing family conflict: Due to changes within a family, such as divorce or separation, a new baby or moving house, and conflicting views or opinions and values between parents and their children who try to develop an own identity can be stressful and damaging to relationships as some parents lose their temper and become intentionally hurtful, aggressive, or violent. 	<ul style="list-style-type: none"> • Pro-social family values: For example, helping, generosity, or sharing. • Low family stress: may improve children's externalizing behaviours, such as acting out in classrooms and fighting, and internalizing behaviours, such as depression and withdrawal. • Good parent or adult/child relationship: These relationships are characterized by caring and responsiveness. • Good parenting skills: For example, supervision and appropriate discipline. Positive communication can defuse conflict and bring about peaceful resolution. • Parent/child attachment: Attachment is the active, affectionate, reciprocal relationship between a parent and child. Their interaction strengthens the bond. Research indicates that securely attached children display improved problem-solving capabilities, emergent literacy skills, overall school adjustment, and mental health. • Positive role models: may inspire children's goals and vision for their lives. • Strong extended family (aunts, uncles, grandparents) • High expectations: For example, schools that establish high expectations for all children and provide the support necessary to achieve them may have high rates of academic success. • Family teaching or support: For example, support programmes for parents with disabled children and financial aid for low-income families. • Family guidance or counsel: Access to legal, social or health services can ensure that a child's right to education is met. • Opportunities for meaningful family involvement: Empathetic family involvement practices (e.g. genuine interest in the activities of other family members) enhance the development of resilience and healthy adjustment among children. Through active participation, children experience increased positive attitudes regarding school, resulting in better school attendance, fewer behaviour problems, and better study and homework habits. • Connections with prosocial organizations: For example, churches, universities, or voluntary community service organizations. • Access to responsive high-quality schools: provides protective environments and can help develop problem-solving, negotiation and collaboration skills that support resilience.

Source: Based on Brooks (2005: 298), Kersting (2004: 13), Kumpfer (1999: 196), Mastropieri & Scruggs (2000: 114), Matthews (1993: 1), Papalia & Olds (1992: 183; 1993: 238-242) and Sheridan *et al.* (2005: 169).

The transactional process that takes place between the children and their social context will be explored in more detail in the following section. In relation to the integrative model, acute environmental stressors are viewed as the stimuli for disruption and integration, thus beginning the resilience process.

4.3 Person-environment interactional process

Kumpfer (1999: 183) mentions that person-environment processes include “transactional processes between the child and his or her environment as the child or caring others either passively or actively attempt to perceive, interpret and surmount threats, challenges or difficult environments to construct more protective environments.”

Research concerning streetchildren (Coles, 1989: 45-79) shows that children living in high-risk environments may actively seek prosocial elements in their environment to reduce risk factors. As a group, these streetchildren were found to be particularly adept at identifying, engaging, and drawing upon supports (e.g. physical and emotional support through peer relations) that do exist, even in a bleak environment. On the other hand, children living in high-risk environments may seek out better environments for themselves by going to a different school or choosing pro-social friends. Hence, children engage in transactional processes to help them transform a high-risk environment into a more protective environment. According to Kumpfer (1999: 191) these transactional processes may include:

- **Identification with and attachment to pro-social people:** for example, non-drug using friends.
- **Cognitive reframing:** refers to “a technique for talking to youth about their strengths, and the intention of motivating youth to act on their own behalf” (Wolin & Wolin, 1999b: 1 of 1). Ashford & Kreiner (cited in Hall & Pearson, 2003: 2 of 13) state that “the ability to reframe negative events by searching for a perspective that is simultaneously truthful and favourable helps people maintain a realistically optimistic perspective.”
- **Planning and dreaming:** implies having a vision for the future and planning strategies to achieve one's goals and dreams according to that vision.
- **Selective perception:** includes seeking positive role models or mentors within the community.
- **Active environmental modification by youth:** for example, choosing to live with a relative in a better neighbourhood.
- **Active coping:** is defined as “constantly changing cognitive and behavioural efforts to manage specific external and/or internal demands that are appraised as taxing or exceeding the resources of the person” (Lazarus & Folkman, cited in Smith & Carlson, 1997: 236). Smith & Carlson (1997: 236) distinguish four steps that characterise the coping process. The first step is *appraisal*. Determining if an event or an situation is stressful, and if so, whether it is controllable. After evaluating one's own coping resources, the stressor, and the likelihood that the coping strategy will be effective, the next step is *selecting a coping strategy*. Active and passive coping strategies are problem-focused (“active”) strategies, such as information-seeking or attempts to alter the actual source of stress; and emotion-focused (“passive”) strategies, which include changing one's outlook, and regulating emotion. Choice of strategies is influenced first by the extent to which stressors are seen as controllable. Emotion-focused strategies focus on adapting to the stressor without altering it, and are therefore employed more often when stressors are seen as uncontrollable. In contrast, problem-focused strategies are used when the stressor is accurately perceived as malleable. The third step, is *carrying out the coping strategy*, and the final step

entails *evaluating the coping efforts*, that is, regarding effectiveness in reducing or eliminating the stressor and managing one's own response to the event.

In their efforts to cope with a stressor or to buffer stressors, and teach themselves even more coping skills, resilient children may draw from resources such as beliefs and values. Physical and mental health may also influence the choice of coping strategy. Knowledge, intelligence, and problem-solving skills (Brooks & Goldstein, 2003: 211; Kumpfer, 1999: 192-3); social skills and contacts, for, amongst other purposes, are used to access social support (Haight, 1998: 214-5; Grotberg, 2003: 124). In more affluent communities children can use economic resources for entertainment or other distractions (Carlson & Smith, 1997: 237) to cope with stressors.

Role modelling, teaching, advice giving, empathetic and emotionally responsive caregiving, creating opportunities for meaningful involvement, effective supervision and disciplining, reasonable developmental expectations, and other types of psychosocial facilitation or support (e.g. intervention programs), are ways of caring and socialisation through which caring others who have been sought out by resilient children, facilitate positive life adaptations and enhancement of protective processes (Brooks & Goldstein, 2003: 229-260; Kumpfer 1999: 19). In summary, people (resilient children) modify consciously or unconsciously their environment or perceive their environment selectively to construct more protective environments.

4.4 Internal self-characteristics

Internal self-characteristics refer to the individual spiritual, cognitive, social and behavioural, physical, and emotional or affective competencies or strengths needed to be successful in different personal environments (Kumpfer, 1999: 184). These different characteristics or domains, indicated in Figure 2.5, are interrelated and influence one another.

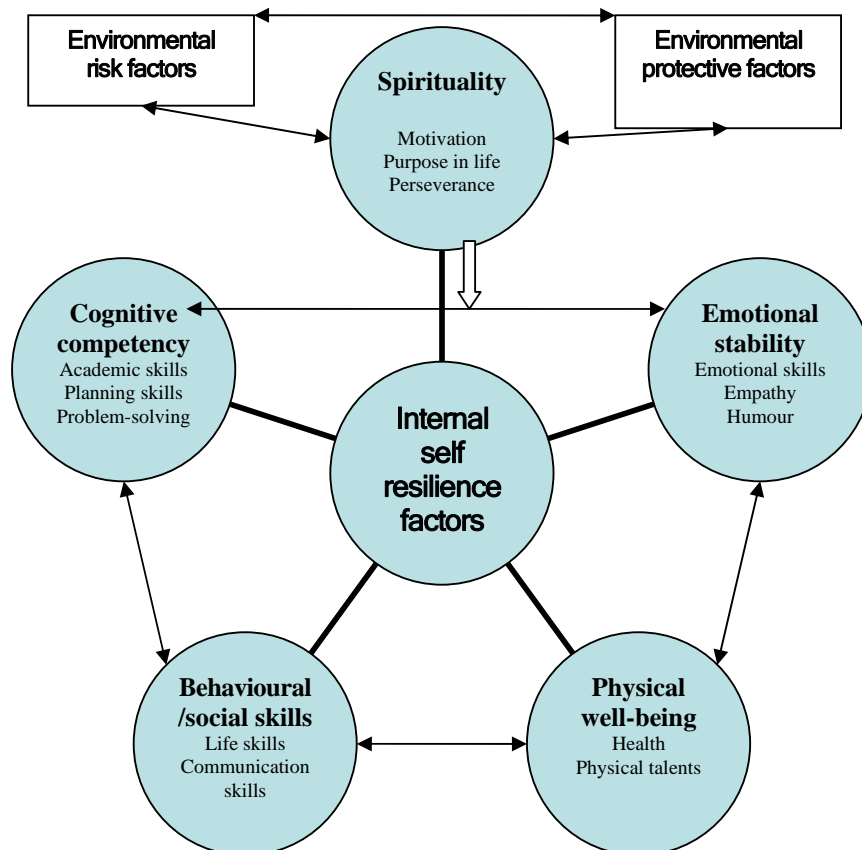

Figure 2.5: Internal self-resilience characteristics

Source: Based on Kumpfer (1999: 196-212).

Happiness (related to the domain of emotional characteristics and skills) is influenced by exercise and good nutrition (Kumpfer, 1999: 209). Thus, biological factors influence whether a child has a generally happy disposition. Similarly, cognitive competencies, such as creativity or insight, and intrapersonal reflective skills can influence behavioural or social competencies, such as problem-solving skills. Kumpfer (1999: 204) mentions that creativity in children at risk allows them the opportunity to improve their self-esteem through creating new ideas which others value or prize. Different aspects within the same domain, also relate to, and influence, one another.

4.4.1 Domains of internal resilience factors

Kumpfer (1999: 197-210) organises internal personality or cognitive capabilities into five major cluster variables or domains (cf. Figure 2.5). These are: (1) spiritual or motivational characteristics; (2) cognitive

competencies; (3) behavioural or social competencies; (4) emotional stability and emotional management; and (5) physical well-being and physical competencies.

Each of these areas of internal competencies and related coping or life skills, as discussed by Brooks & Goldstein (2003), Kumpfer (1999: 197-210), McConnell (1974: 381) and Wright & Masten (2005: 24) will be summarised in the following section to provide a brief overview of the core traits that characterise resilient children. The function of each domain, that is, the role of internal personality or cognitive capabilities in children's lives; variables pertaining to the specific area; and reported research findings, will be discussed.

In my opinion, many of these characteristics correlate directly with the characteristics of successful leaders. By meeting challenges and acquiring attributes of resilience, leaders overcome the odds and succeed. For resilient children too, the rough or difficult roads they traverse may become the very foundation for leadership and success.

All children have the potential to become leaders in their own right. The development of the following traits that characterise resilient children is imperative therefore to enable children to become leaders who can make a difference and can shape the future.

4.4.1.1 Spiritual or motivational characteristics

Spiritual or motivational characteristics serve to motivate children and create direction for their efforts. For resilient children, these characteristics also provide an anchorage and stability within adverse situations.

The spiritual or motivational cluster of resilience characteristics includes cognitive abilities primarily. Cognitive variables are thoughts about dreams or goals and purpose in life; spirituality; existential meaning for life; belief in uniqueness or in oneself; and independence. They also pertain to internal locus of control, hopefulness and optimism; determination; and perseverance.

Research findings confirm that resilient children show the ability to dream, create plausible fantasies for themselves, and develop a mission or purpose for their lives. A predominant characteristic of resilient children is having a purpose in life related to helping others. This, in turn, helps them to find a purpose for their lives, to heal, and to regain environmental mastery and perceived control to maintain hope in adverse situations. Long term planning abilities, determination, flexibility, perseverance, and the ability to rebound by developing new goals and plans when former plans fail are therefore regarded important in achieving their mission in life.

Religious faith or affiliation was found to be highly predictive of positive life adaptation. Belief in uniqueness or in oneself was reported to motivate resilient individuals towards positive achievement. Religious instruction or adult support has proved to reinforce this specialness.

Belief in later, more fulfilling gratification or saving themselves from intensely unpleasant future experience helps resilient children to delay immediate gratification in order to be successful. These children may avoid negative peer pressure so as to participate in goal-directed activities (e.g. saving money for future education). Hence, resilient children were found to be achievement orientated, autonomous, and self-directed. They have more internal locus of control (i.e. the child behaves as if control for his or her life comes from internal, autonomous sources), and are more hopeful about their ability to create positive outcomes for themselves and others.

4.4.1.2 Cognitive competencies

Cognitive abilities help the child to achieve dreams or goals. Cognitive competencies may also help to connect children with environments outside their immediate environment or situation.

Individual resilience characteristics include the cognitive abilities of resilient children. Variables that pertain to this area are intellectual competence, and academic and job skills; moral reasoning; insight and intrapersonal reflective skills; self-esteem and the ability to restore self-esteem; planning ability; and creativity.

Resilient children are reported to have higher intellectual and academic abilities. They are achievement orientated and are thus capable of delaying gratification in order to be successful. High verbal and reading skills tend to help them learn more about the world outside their family and neighbourhoods. Knowledge attained in this way may open the door to new pathways for achievement, success, the setting of new goals, and higher standards. This knowledge may also motivate the child to reach for, and accomplish, new goals.

Resilient children are capable of attaining and demonstrating higher levels of moral reasoning and tend to separate themselves from the value systems of their families by becoming their own moral guardians. They are capable of cognitive aspects of morality, such as judging right from wrong, developing internal images or standards for the way things should be or what is normative, valuing compassion, fairness and decency, and serving others.

Resilient children have the capability to analyse their own psychological and physical strengths and limitations in relation to others. Resilient children from dysfunctional parents often develop “adaptive distancing” to protect their sense of healthy separation from the parent’s maladaptive coping skills and life patterns. Hence, the ability to find more successful role models is adaptive for these children.

The resilient child has higher self-esteem or an accurate appraisal of their strengths and capabilities, a strong sense of self-efficacy, and the ability to restore self-esteem after failure. When children are determined and persevere to overcome stressors or master challenges, then self-efficacy, self-esteem, resilience, and competencies are developed. Creativity enhances self-esteem and allows children to express and resolve inner conflicts from a troubled past.

The ability to plan a bright future and to take possible obstacles and consequences of choices into account, characterise children who successfully overcome negative environments. Children who have planning abilities and internal locus of control to use these abilities are thought to be less likely to engage in behaviours with life-long negative consequences, such as drug abuse or teenage sexuality. In essence, cognitive abilities link with spiritual or motivational characteristics, for children to create and attain future goals and dreams.

4.4.1.3 Behavioural or social competencies

Behavioural or social competencies include skills and talents that help children to accomplish aims. The characteristics of resilient children, considered primarily within the behavioural or social competencies domain are social skills and street “smarts;” multi-cultural and bi-gender competencies; empathy and interpersonal social skills; and .problem-solving skills. These skills are also employed by resilient children to function effectively within different environments. In contrast with the cognitive domain, behavioural and social competencies require action, not just thoughts.

Behavioural or life skills, such as communication skills, problem-solving skills and peer-resistance skills, are employed by resilient children to function effectively within different environments. An excellent problem-solving ability and the ability to focus on the goal may lead to increased self-efficacy, belief in personal control, optimism, initiative and willingness to tackle new challenges.

Resilient children tend to show the ability, interest, and motivation to solve problems through a generalised cognitive - affective - behavioural response set: they identify the problem accurately; generate a wide variety of possible solution; consider the consequences of each possible solution; and implement the best possible solution and verify the results to learn better strategies for later problems. Hence, creative problem-solving, flexibility, and originality have been considered a hallmark of these children.

Children, who can act with competence in several cultures, are more resilient. In addition, bi-gender competence is related to increased resilience in the female gender. Resilient children display a sense of responsibility for others, a willingness to care for others, the ability to be empathetic of the needs of others, and a capacity for intimacy. Related coping skills include an engaging personality, good listening and communication skills, and politeness.

These children are responsive and active in their relationships with others. They tend to elicit positive responses from others and have the ability to establish friendships with positive pro-social peers and, as explained before, get the social supports they need.

4.4.1.4 Emotional stability and emotional management

Characteristics within the emotional stability and emotional management domain help the child to maintain social standing and friendships. The resilient child may have to establish good health practices to maintain emotional stability and emotional management. Emotional stability and emotional management variables that correlate with resilience are happiness; emotional management skills; and humour.

Good mental health practices, such as avoidance of psychotropic drugs, eating well, reducing stress, and getting exercise may lead to optimism and the ability to be hopeful. Resilient children who employ these practices are found to be reasonably happy, energetic, and tend to avoid negative appraisals of reality.

Closely related to an optimistic and hopeful disposition is the ability of resilient children to recognize feelings and control undesirable feelings, such as fear, anger, and depression. In these instances, humour may be used by children as a coping strategy to reduce tension and stress so as to restore perspective. These abilities are learned through role modelling and parent-child transactions.

4.4.1.5 Physical well-being and physical competencies

Physical well-being and physical competencies help the child to attract caring others and maintain general well-being. These competencies or factors may function, therefore, as a protective support system for the child. The physical well-being and physical competencies cluster include variables, such as good health and health maintenance skills; physical talent development; and physical attractiveness.

Better physical health has been related to resilience in children. Children with few physical problems, good sleep patterns, and physical strength, may interpret themselves as “strong” psychologically as well.

Additionally, children may increase their self-worth and self-efficacy by developing physical talents or accomplishments that are valued by themselves and others, such as becoming a good athlete or artist. Having a coach or teacher increases the child’s opportunities for role modelling and support. This, in turn, may contribute to resilience.

Attractive children are generally more liked and valued by parents, and find it easier to attract caring others. Hence, physical status or appearance has been found to be predictive of resilience.

4.5 Internal individual resilience factors

Nested within the internal resilience factors, discussed before (cf. 4.4, p. 25-30), Kumpfer (1999: 193) identifies intelligence, gender, temperament and personality, and neurotransmitter imbalances, as internal individual resilience factors that may determine children's resilience to life stresses.

Factors related to increased resilience in children are higher cognitive levels; female gender (cf. p. 29); positive temperament traits or positive personality disposition; for example, the ability to be comforted after stress or responsiveness to environmental change; absence of biological chemical imbalances (neurotransmitter and hormonal imbalances) and avoidance of drugs that may lead to neurotransmitter imbalances, which, in turn, can increase the craving for drugs.

4.5.1 Paradigm of resilience factors

Wolin & Wolin (1999d: 1 of 1) used the word "resiliencies" to describe clusters of strength that are mobilized in the struggle with hardship or adversity. Seven resiliencies are identified, referred to as a vocabulary of strengths. These strengths correlate with the internal self-resilience factors mentioned by Kumpfer (1999: 197-210), and include:

- **Insight:** asking tough questions and giving honest answers.
- **Independence:** distancing oneself emotionally and physically from the sources of trouble in one's life.
- **Relationships:** making fulfilling connections to other people.
- **Initiative:** taking charge of problems.
- **Creativity:** using imagination and expressing oneself in art forms.
- **Humour:** finding the comic in the tragic.
- **Morality:** acting on the basis of an informed conscience.

Grotberg (1995: 9) groups these internal-self characteristics, as well as the external environmental factors mentioned before (cf. 4.2 and 4.4), in three categories or sources of resilience, also referred to as the "language of resilience" (I HAVE; I AM; I CAN). She suggests that resilient children draw from these three categories to rise above adversity and live successfully (cf. Figure 2.6). The discussed research findings following the heading "Domains of internal resilience factors," provide an explanation as well as examples of how the process indicated in Figure 2.6 works.

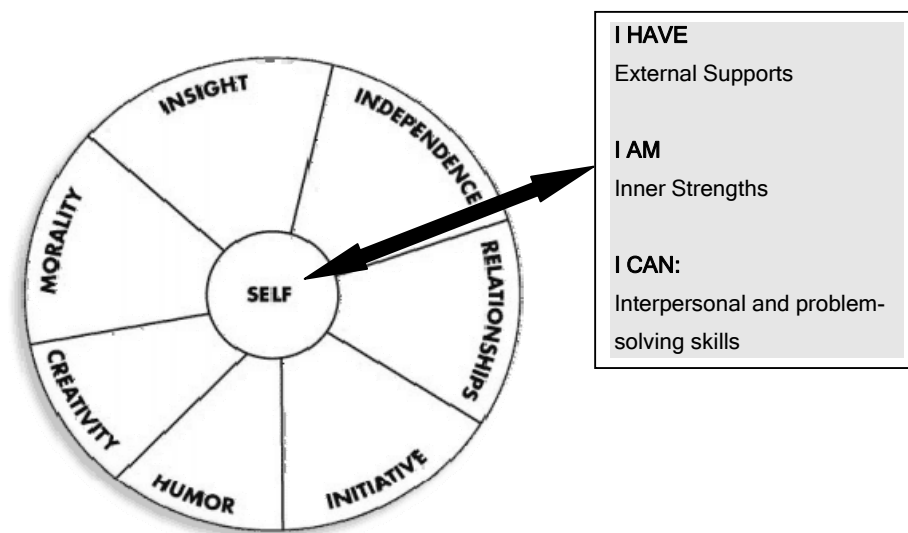

Figure 2.6: The resilience mandala (a)

Source: Adapted from Wolin & Wolin (1999d: 1 of 1).

Table 2.4 indicates the three categories of resilience and provides a framework for understanding the construct of resilience. The table may be considered as a summary of the previously mentioned internal-self resilience factors and external environmental factors explored in 4.4 and 4.2.

TABLE 2.4: Three categories of resilience		
External supports promote resilience:	Inner strengths develop over time and sustain those dealing with adversities:	Interpersonal, problem-solving skills deals with the actual adversity:
<ul style="list-style-type: none"> • Family • School • Availability of support systems for parents • Community • Peer group • Culture 	<ul style="list-style-type: none"> • Locus of control • Morality • Temperament • Self-image • Independence or Autonomy • Ego strength • Empathy • Responsibility • Self-discipline • Self-worth • Self-awareness 	<ul style="list-style-type: none"> • Creativity • Humour • Intellectual ability • Ability to manage stress • Communication • Problem-solving • Impulse control • Persistence • Social support and the need for trusting relationships • Compassion • Confidence • Competence • Caring
I HAVE:	I AM:	I CAN:
<ul style="list-style-type: none"> • one or more persons within my family that I can trust and who love me without reservation; • one or more persons outside my family I can trust without reservation; • limits to my behaviour; • people to encourage me to be independent; • good role models; • access to health, education, and the social and security services I need; and • a stable family and community. 	<ul style="list-style-type: none"> • a person most people like; • generally calm and good natured; • an achiever who plans for the future; • a person who respects myself and others; • empathic and caring of others; • responsible for my own behaviour and accepting of the consequences; and • a confident, optimistic, hopeful person, with faith. 	<ul style="list-style-type: none"> • generate new ideas or ways to do things; • stay with a task until it is finished; • see the humour in life and use it to reduce tensions; • express thoughts and feelings in communication with others; • solve problems in various settings - academic, job-related, personal, and social; • manage my behaviour- feelings, impulses, acting out; and • reach out for help when I need it.
FACTORS THAT PROMOTE RESILIENCE		
<p>When dealing with an adversity, the child draws from a combination of these factors as needed. Although, interplay between these factors exists, they can be promoted separately. The building blocks of growth and development that correspond to the resilience factors listed above are trust, autonomy, initiative, industry, identity, intimacy, generativity and integrity.</p>		

Source: Based on Dent and Cameron (2003: 4), Eberson (2001: 27-37), Goldstein & Brooks (2002: 193, 229), Grotberg (2003: 5; 1995: 9), Hippe (2004: 240), Kumpfer (1999: 183) and Middel (2001: 14-20).

4.6 Resilience processes

The final process, that predicts a positive outcome associated with resilient children, is the interaction between the internal characteristics of a child and the outcome. To elucidate the resilience process, Kumpfer (1999: 184) identifies unique short-term or long-term resilience or stress/coping processes that help children to bounce-back with resilient reintegration. These unique short-term or long-term resilience processes are

learned by the individual through gradual exposure to increasing challenges and stressors. A discussion of these processes follows.

4.6.1 Resilience as the ability to bounce back

The process of bouncing back may be understood as recovery and (maintained) adaptive behaviour that follows initial retreat or incapacity upon initiating a stressful event (Kumpfer, 1999: 210). The term “resilience” is used to describe a set of qualities that foster a process of successful adaptation and transformation, despite risk and adversity. Thus, the ability to bounce back from adversity may be considered as a central concept of resilience.

Although resilience or the ability to bounce back from adversities occurs more naturally in some children than others, it is an ability or skill that can be learned. Children can learn how to view, and think about challenges, setbacks, adversities, the world, and themselves differently. Thus, children develop a “resilient mindset,” that is “a set of ideas, beliefs, attitudes, skills, and assumptions, all of which guide our behaviour relative to a specific topic or issue” (Goldstein & Brooks, 2002: 4), that enable children to bounce back from stressful and negative experiences. (Goldstein & Brooks, 2002: 5; Hall & Pearson, 2003: 2; Parachin, 2004: 1-6 of 6).

4.6.2 Resilience as learning

Claxton (1999: 6) views resilience as part of the three R's (resilience, resourcefulness, and reflectiveness) of learning power. Resilience, and learning too, is thought to be part of everyday living. A child may, for example, fall down and get up repeatedly in the process of learning how to walk. The process of learning is considered to be challenging (cf. 3.2), often accompanied by frustration, disappointment, surprise, failure, confusion, or apprehension. Consistent with the experiences children might face in the process of everyday learning,

[b]eing resilient does not mean that a person doesn't experience difficulty or distress. Emotional pain and sadness are common in people who have suffered major adversity or trauma in their lives. In fact, the road to resilience is likely to involve considerable emotional distress (Comas-Diaz *et al.*, 2004: 1 of 1).

The development of resilience or the ability to recover from setbacks is therefore required to ensure success. However, Fraser, Richman & Galinsky (1999: 136) argue that the term *resilience* “is reserved for unpredicted or markedly successful adaptations to negative life events, trauma, stress, and other forms of risk.” This explanation highlights a different viewpoint of resilience, perhaps that of an exceptional or extraordinary ability exhibited in the face of what might be considered more serious adversities, such as war or poverty.

Anthony & Cohen (cited in Dent & Cameron, 2003: 5) seem to support this argument by stating that the “term carries the concept of springing back from major difficulties and negative experiences.”

In this regard, Grotberg (2003: 1) mentions that resilience includes the capacity to learn from the inevitable adversities of life. Similarly, Brody (2005: 2 of 3) reports:

As Dr. Robert Brooks of Harvard and Dr. Sam Goldstein of the University of Utah put it, being resilient does not mean a life without risks or adverse conditions but rather learning how to deal effectively with the inevitable stresses of life.

Although the previously mentioned distinction has been made, both viewpoints inevitably subsume the concept of learning. Comas-Diaz *et al.* (2004: 1 of 1) add that “resilience is not a trait that people either have or do not have. It involves behaviours, thoughts, and actions that can be learned and developed in anyone.” I conclude, whether resilience is practiced in the face of adversity pertaining to everyday living and development (for example, learning to walk or academic learning) or major difficulties (such as abuse or war), resilience implies learning from experience.

4.6.3 Resilience as reintegration

As explained before (cf. 3.2), children develop through a process of meeting challenges, resolving them, and facing new ones. If the challenge is severe (beyond the child’s age-appropriate level of development or capacity) the process too breaks down. If the child fails, but develops as a stronger person in the process, some type of resilience process is occurring. In revision, this process is initiated by a stressor that may lead to “imbalances in homeostasis or disruption.” Disorganisation of the child occurs that may be relieved or countered by envirosocial supportive processes, mentioned in 4.3 (Kumpfer, 1999: 210-11). This results in what is referred to as “reintegration.” Several different levels of reintegration based on envirosocial processes can occur (Kumpfer, 1999: 211), namely:

- 1) **resilient reintegration** or a higher state of resilience and strength;
- 2) **homeostatic reintegration** or the same state before the stressor;
- 3) **maladaptive reintegration**, or a lower state of reintegration; and
- 4) **dysfunctional integration** or major reduction in positive reintegration.

Kumpfer (1999: 211) also states that the level of reintegration or “the positiveness of the level of homeostasis” does change over time. Johnson (1999: 227) refers to Piaget’s theory of how children move from one cognitive developmental stage to another to explain how psychological growth occurs. According to Johnson (1999: 227), Piaget’s theory centres on the process of equilibration, much like homeostasis, referred to by Kumpfer (1999: 211). As mentioned before, when this state is interrupted, disequilibrium occurs. This provides the opportunity for psychological growth, thereby allowing movement from stage to stage.

For the resilient child, this means that psychological growth or development does occur (Kumpfer 1999: 210). For instance, insight begins with sensing in childhood, becomes knowing in adolescence, and matures into understanding in adulthood (Wolin & Wolin, 1999a: 2 of 5). For each of the seven resiliencies in the vocabulary of strengths (cf. 4.5.1, p. 31), three developmental phases are identified: child, adolescent, and adult. (Wolin & Wolin, 1999a: 1 of 5). The resilience mandala in Figure 2.7 represents the resiliencies schematically, and indicates the general concept of resilience at each stage of development. Wolin & Wolin (1999a: 1 of 5) explain that, in children, resiliencies appear as unformed, non-goal-oriented, intuitively motivated behaviour (cf. examples in the second innermost ring of the mandala in Figure 2.7). These behaviours sharpen and become deliberate in adolescents and in adults. They broaden and deepen, becoming an enduring part of the self.

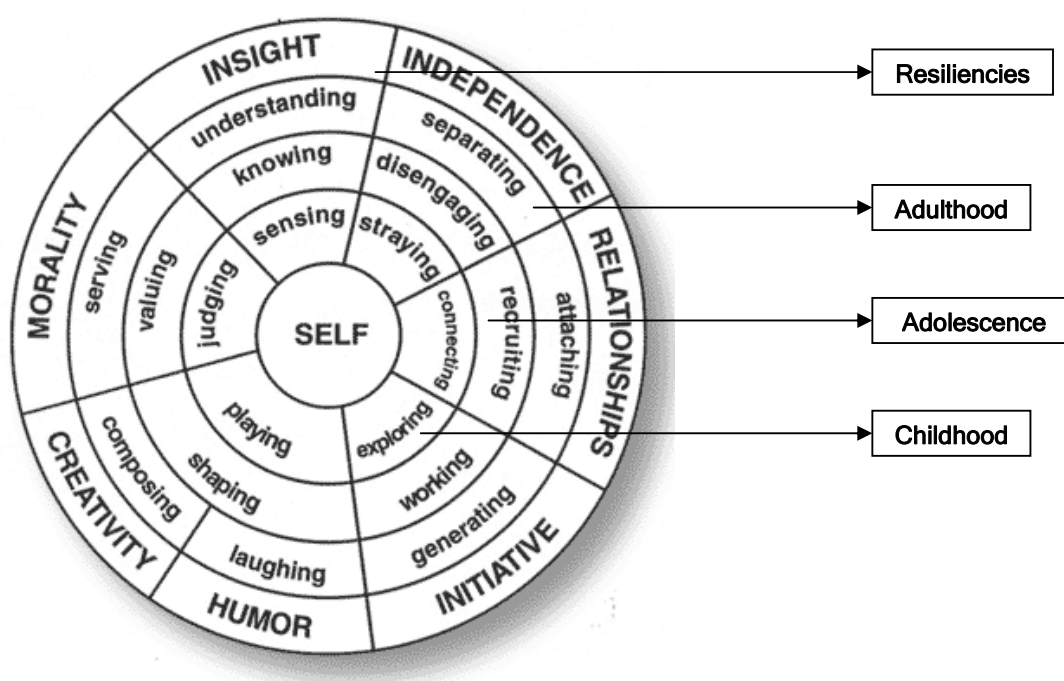

Figure 2.7: The resilience mandala (b)

Source: Adapted from Wolin & Wolin (1999a: 2 of 5).

I assume that, not only do children develop from one phase (e.g. childhood) to another (e.g. adolescence), and from sensing to knowing, but also develop or “move” within the concentric circles or stages (cf. Figure 2.7) within in a particular phase. The stressed behaviour of a pre-adolescent (cf. Table 2.1) exposed to adversity may, indicate regression, for example, meaning that the child may only sense that there is a problem and not know what the problem is. Resilient reintegration may therefore be indicated by, amongst

other observations (e.g. acceptance), knowing what the problem is, and an eventual understanding of the problem or insight in adulthood.

In conclusion, “resilience (including development) becomes a personal negotiation through the complexities of risk and protective factors available to individuals” (Dent & Cameron, 2003: 4; Johnson, 1999: 227). Resilience, therefore, does not mean merely that a transaction of giving and receiving between the child and his/her environment takes place, but “risk and protective factors are filtered through the thoughts about what this giving means, what it meant in the past, and what it might mean in the future” (Johnson, 1999: 227).

4.7 Positive life outcomes

Positive outcomes refer to successful life adaptation in specific developmental tasks; that is, expectations of a given society in a historical context for the child’s accomplishment of specific tasks at the appropriate stage of development (Wright & Masten, 2005: 20). These adaptations are supportive of later positive adaptation in specific new developmental tasks. This culminates in a higher likelihood that the child may be considered as a resilient individual when adulthood is reached. “A positive outcome suggesting resilience is also predictive of later resilient reintegration after disruption or stress” (Kumpfer, 1999: 184).

Manaster (1977: 13) maintains that all the problems of life can be included within five life-task headings: (1) love and sex; (2) work and school; (3) friends and community (society); (4) self; and (5) the meaning of life (existential task). These tasks are of different importance to different individuals throughout their lives, but, from early adolescence to death, all their problems and efforts are inevitably related to these life tasks. Viewed in terms of the integrative model, the life-task approach provides a structure for looking at the manner in which children may cope with the environment - from the internal environment (self) to the most external environment (the self and the universe). Thus, this perspective allows us to maintain a holistic view of people while categorising the goals of their efforts within five distinct, but related tasks. Hence, the challenge for resilient children remains, according to Staudiger *et al.* (1993: 541), to maintain “healthy development despite the presence of threat and to the recovery of trauma” within the five previously mentioned, related life-tasks.

Maslow’s approach concerning human development coincides with resilience theory in that it focuses primarily on the “healthy side of man’s nature” (McConnell, 1974: 630). According to McConnell (1974: 630), Maslow argues that human beings (children) are intrinsically motivated to meet basic psychological needs by an active will towards health. I conclude that development within different stages and related tasks, viewed in terms of Maslow’s theory, denotes that resilient children exposed to adversities or risk factors are intrinsically motivated to draw on internal resilience factors and to develop internal strengths to meet basic psychological needs, such as a need for belonging, autonomy, identity, safety, and so forth (Middel, 2001: 42). In this sense, eventual self-actualization may be “redefined as the perceived competence to satisfy these needs” (Heylighen, 1992: 39) within age appropriate stages of development.

Grotberg (2003: 5) refers to Erickson's stages of development: trust, autonomy, initiative, industry, identity, intimacy, generativity, and integrity to show how the acquisition and completion of each task is closely linked with resilience. During Erickson's *industry phase*, for example, the crisis children are faced with is that of competence or failure (McConnell, 1974: 627). Viewed in terms of the resilience mandala (Figure 2.7), the child develops or "moves" from play to work. Earlier play at activities, with little or no attention given to the quality of results, changes to activities that require the child to perform and produce good results. Children achieve the tasks of this phase by mastering both academic and social skills, and by being able to work diligently at a task (Grotberg, 2003: 8). According to Table 2.4, Grotberg (2003: 9) suggests that, from the I HAVE category, good role models and encouragement to be independent are important; being an achiever who plans for the future and who is responsible for his or her own behaviour (I AM category) is helpful; and the ability to stay with a task until it is finished, problem-solving, and reaching out for help when it is needed; are important in mastering the necessary skills to achieve the tasks within the industry phase. Successful achievement of academic skills and/or interpersonal relationships may lead to positive outcomes characteristic of resilient children, such as high self-worth and positive self-image as an achiever (Brooks & Goldstein, 2003: 5, Grotberg, 1995: 29).

In addition, positive outcomes observed amongst children faced with adversity, who have been labelled "resilient," include the fact that they have no psychiatric diagnosis, relate well to peers and adult authorities in school and at home, have a positive self-concept, and are performing at grade level in school. In addition, health, self-actualisation, optimisation of gratification, and reality-orientated self-acceptance are identified as positive outcomes amongst children (Kaplan, 1999: 20, 32). Again, consistent with these observations and, referring more specifically, to self-actualisation as an outcome amongst resilient children, Masten & Coatsworth (cited in Middel, 2001: 12) state that resilience is "manifested competence in the context of significant challenges to adaptation or development." I conclude that competence, viewed in terms of self-actualisation as an outcome observed amongst children considered to be resilient, reflects the following characteristics of self-actualizing people (McConnell, 1974: 630):

- they have more efficient perceptions of reality and are more comfortable with it;
- they accept themselves and their own natures almost without thinking about it;
- their behaviour is marked by simplicity and naturalness, and by lack of artificiality or straining for effect;
- they focus on problems outside themselves; they are concerned with basic issues and eternal questions;
- they like privacy and tend to be detached;
- they have relative independence of their physical and social environments; they rely on their own development and continued growth;
- they do not take blessings for granted, but appreciate again and again the basic pleasures of life;
- they experience limitless horizons and the intensification of any unself-conscious experience often of a mystical type (in other words, the conscious experience of something (spiritual) other than the self);
- they have a deep feeling of kinship with others;
- they develop deep ties with a few other self-actualising individuals;
- they are democratic in a deep sense; although not indiscriminate, they are not really aware of differences;

- they are strongly ethical, with definite moral standards, though their attitudes are conventional; they relate to ends rather than means;
- their humour is real and related to philosophy, not hostility; they are spontaneous less often than others, and tend to be more serious and thoughtful;
- they are original and inventive, less constricted, and fresher than others;
- while they tend toward the conventional and exist well within the culture, they live by the laws of their own characters rather than those of society; and
- they experience imperfections and have ordinary feelings, like others.

Thus, although many clinical practitioners define resilience on the basis of a child meeting the requirements of developmental tasks, Goldstein & Brooks (2005: 9) rightly caution: “a child facing multiple developmental adversities who does not develop significant psychopathology but who may not demonstrate academic or social achievements, may be resilient as well.” To reiterate, children are considered vulnerable to particular negative outcomes (such as illness, maladaptive behaviour, substance abuse, or psychopathology) by virtue of being at-risk (Kaplan, 1999: 20; 32-3). Simply stated, vulnerable children are those who turn out poorly and considered to be at risk. (Brentro & Larson, 2004: 196; Kaplan, 1999: 20). Resilient children are those who are considered to turn out well.

5. SUMMARY

The intention of this chapter was to offer a foundation for understanding, conceptualising and exploring the concept of resilience in children. Hence, resilience was investigated in terms of a process, consisting of various related processes and constructs, organised within a dynamic model of resilience to provide a holistic picture of what the term entails (cf. Figure 2.8).

This review suggests that virtually all aspects of a child’s personality and environment influence development and positive life adaptation. At the most fundamental level, resilience theory validates prior research and theory in human development that has established that growth and development within certain age-appropriate stages and related tasks is part of a child’s make-up which unfolds naturally in the presence of certain environmental attributes. Resilience theory holds further that adversities and/or risk factors within the child’s environment may threaten or challenge healthy development or even lead to negative developmental outcomes. Resilient children are, however, able to draw from protective factors within their internal and external environment to “bounce back”, adapt and learn from those life events and circumstances to achieve positive developmental outcomes.

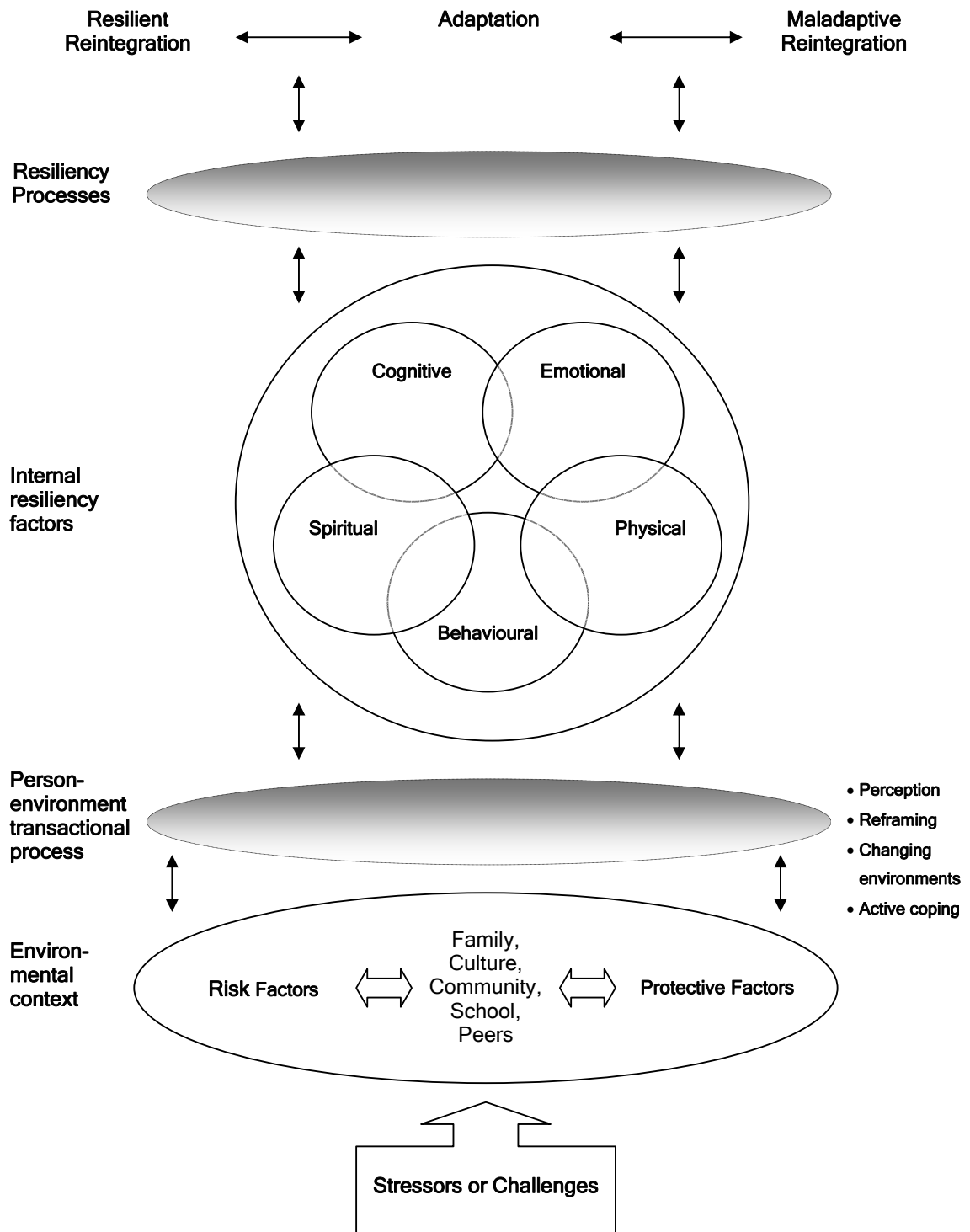

- Perception
- Reframing
- Changing environments
- Active coping

Figure 2.8: The integrative model

Source: Adapted from Kumpfer (1999: 185).

Ultimately, resilience is a process marked by the interaction between the child and his or her environment. For children, this interaction is characterised by the development and use of traits commonly found in resilient children. Traits that characterise resilient children include social competence (which incorporates responsiveness, cultural flexibility, empathy, caring, communication skills, and a sense of humour); problem-solving (which includes planning, help-seeking, critical and creative thinking); autonomy (sense of identity, self-efficacy, self-awareness, task-mastery, and adaptive distancing from negative messages and conditions); and a sense of purpose and belief in a bright future (which denotes goal direction, educational aspirations, optimism, faith, and spiritual connectedness) (Benard, 1991: 11-12; 2004: 2 of 8; Milgram & Palti, 1993: 207; Vanderpol, 2002: 303-4). Resilient children employ these traits and so find pathways to future success.

Within an organisational-developmental framework, resilience may thus be broadly defined as the ability to use external and internal resources successfully to resolve developmental issues and life-tasks. The child shows the tendency to achieve “wholeness not as a static state, but as a dynamic, flexible balance that permits recoil or regression and rebound or progress” (Murphy, cited in Kaplan, 1999: 64). The interaction between children (affected by HIV/AIDS) and their environment, and the use and development of self-efficacy as a hallmark of resilient children, is the focus of the next chapter.

Chapter 3

DEVELOPMENTAL ASSETS AND CHILDREN ORPHANED BY AIDS: THE EXTERNAL AND INTERNAL ENVIRONMENT

1. INTRODUCTION

The impact of HIV/AIDS on the lives of children can impede development or reinforce "maladaptive and destructive responses toward both the environment and the self" (Bronfenbrenner & Ceci, 1994: 572, *Children on the Brink*, 2004: 16; Guest, 2003: 12). Research shows that the more developmental assets children have, the more likely they are to avoid a wide range of high-risk behaviours, to engage in positive conduct, and to grow up to be caring, competent, responsible young people (Howard & Johnson, 2000: 1; Mannes, Scales, Benson & Roehlkepartain, 2001: 705; Scales, 2000: 84-5; Sesma *et al.*, 2005: 285). For children, this positive conduct may include applying themselves in school, helping others, valuing diversity, maintaining good health, resisting danger, exhibiting leadership, delaying gratification, and being resilient in the face of challenges, stresses, and difficult situations (Thompson, n.d.: 19). The development and use of assets in children affected by HIV/AIDS is therefore critical.

The main concern of this chapter is to investigate how developmental assets operate in children's lives to help them cope amid exposure to adversities. First, this chapter conceptualises developmental assets as a multifaceted phenomenon grounded in an interplay among personal (internal assets), contextual, and social factors (external assets). Secondly, the aim of this chapter is to present a more detailed description of the underlying child-environment interactive processes and mechanisms that facilitate children's development of assets and resilience. Lastly, phases of development are reviewed.

2. THE CONCEPT OF DEVELOPMENT

Children and their environment interact, change, and develop over time (cf. p. 39 and 41). Bronfenbrenner's model of the ecology of human development (cf. Figure 2.4) acknowledges that humans do not develop in isolation, but in relation to their family and home, school, community, and society. Characterised by the process of change, children's development affects their lives in many ways: physically (e.g. the ability to move), emotionally (the ability to feel), socially (the ability to relate to others), and cognitively (the ability to think) (Steinberg & Belsky, 1991: 31; Bentzen, 2005: 21). Table 3.1 lists the developmental assets that influence the interaction between multiple environments.

TABLE 3.1: Developmental assets framework	
EXTERNAL ENVIRONMENT	INTERNAL ENVIRONMENT
ASSET CATEGORIES	
External assets	Internal assets
<p>Support: children need to experience support, care and love from their families, neighbours and many others. They need organizations and institutions that provide positive, supportive environments.</p> <ul style="list-style-type: none"> • Family support • Positive family communication • Other adult relationships • Caring neighbourhood • Caring out-of-home climate • Parent involvement in out-of-home situations <p>Empowerment: children need to be valued by their community and have opportunities to contribute to others. For this to occur, they must be safe and feel secure.</p> <ul style="list-style-type: none"> • Community values children • Children are given useful roles • Service to others • Safety <p>Boundaries and expectations: children need to know what is expected of them and whether activities and behaviours are "in bounds" or "out of bounds."</p> <ul style="list-style-type: none"> • Family boundaries • Out-of-home boundaries • Neighbourhood boundaries • Adult role models • Positive peer interaction and influence • Appropriate expectations for growth <p>Constructive use of time: children need constructive, enriching opportunities for growth through creative activities, youth programmes, congregational involvement, and quality time at home.</p> <ul style="list-style-type: none"> • Creative activities • Out-of-home activities • Religious community • Positive, supervised time at home 	<p>Commitment to learning: the development of a lifelong commitment to education and learning.</p> <ul style="list-style-type: none"> • Achievement expectation and motivation • Children are engaged in learning • Stimulating activity and homework • Enjoyment of learning and bonding to school • Reading for pleasure <p>Positive values: the development of strong values that guide their choices</p> <ul style="list-style-type: none"> • Caring • Equality and social justice • Integrity • Honesty • Responsibility • Healthy lifestyle and sexual attitudes <p>Social competencies: the development of skills and competencies that equip children to make positive choices, to build relationships, and to succeed in life</p> <ul style="list-style-type: none"> • Planning and decision making • Interpersonal skills • Cultural competence • Resistance skills • Peaceful conflict resolution <p>Positive identity: the development of a strong sense of their own power, purpose, worth, and promise.</p> <ul style="list-style-type: none"> • Personal power • Self-esteem • Sense of purpose • Positive view of personal future

Source: Based on Sesma *et al.* (2005: 283-4), Scales & Roehlkepartain (2003: 2).

To understand HIV/AIDS-affected children's behaviour and development (and use of personality traits or assets), it is thus important to understand each child against the background, or within the context of (multiple) environments (Sesma *et al.*, 2005: 282; Papalia & Olds, 1993: 14). These environments may be broadly categorized as the external and internal environments. Figure 3.1 illustrates this concept and forms the platform for subsequent discussions.

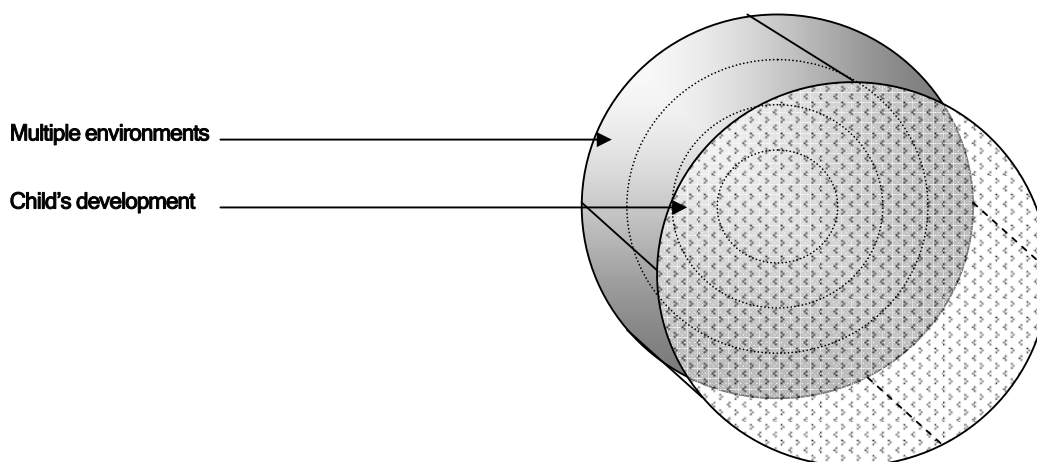

Figure 3.1: The environment and development

Source: Based on Bee (1989: 10), Papalia & Olds (1993: 14).

2.1 External or situational factors and realities in South Africa

Goldstein & Brooks (2002: 2) argue that “although growing up has always presented its share of challenges and pressures for children, we believe there are many more challenges facing children today than fifty years ago.” This statement is even more true for children living in South Africa, affected by HIV/AIDS. Research indicates that comparing the conditions in which South African children have to develop with those of children in Switzerland, for example, reveals that South African children experience considerably more stressors (Middel, 2001: 30). Furthermore, with specific reference to the HIV/AIDS epidemic, Cook & du Toit (n.d.:2 of 20) state that “among the countries most affected by the disease, South Africa is experiencing the crushing burden of having the highest number of persons living with AIDS of any country in the world.”

“[T]he majority of South African children can [thus] be considered to be grossly disadvantaged and as being at risk for less than optimal psychological development” (Dawes & Donald, 1994: 1). To this can be added social relationships, academic and subsequent professional success, tolerance of frustration and failure, and self-esteem (Eberson, 2001: 41-2; Middel, 2001: 30; 112, Steyn, 2005: 8). This may pose a great threat, not

only to the development of these children, but according to Beresford (2002a: 6), the *Diamond Fields Advertiser* (2003: 20), the *Weekly Mail and Guardian* (2003: 31), and to Stein (2003: 4), also to society.

The impact of HIV/AIDS, as well as the resulting, or existing external or situational factors and realities that may influence the development of children, is summarised in Figure 3.2.

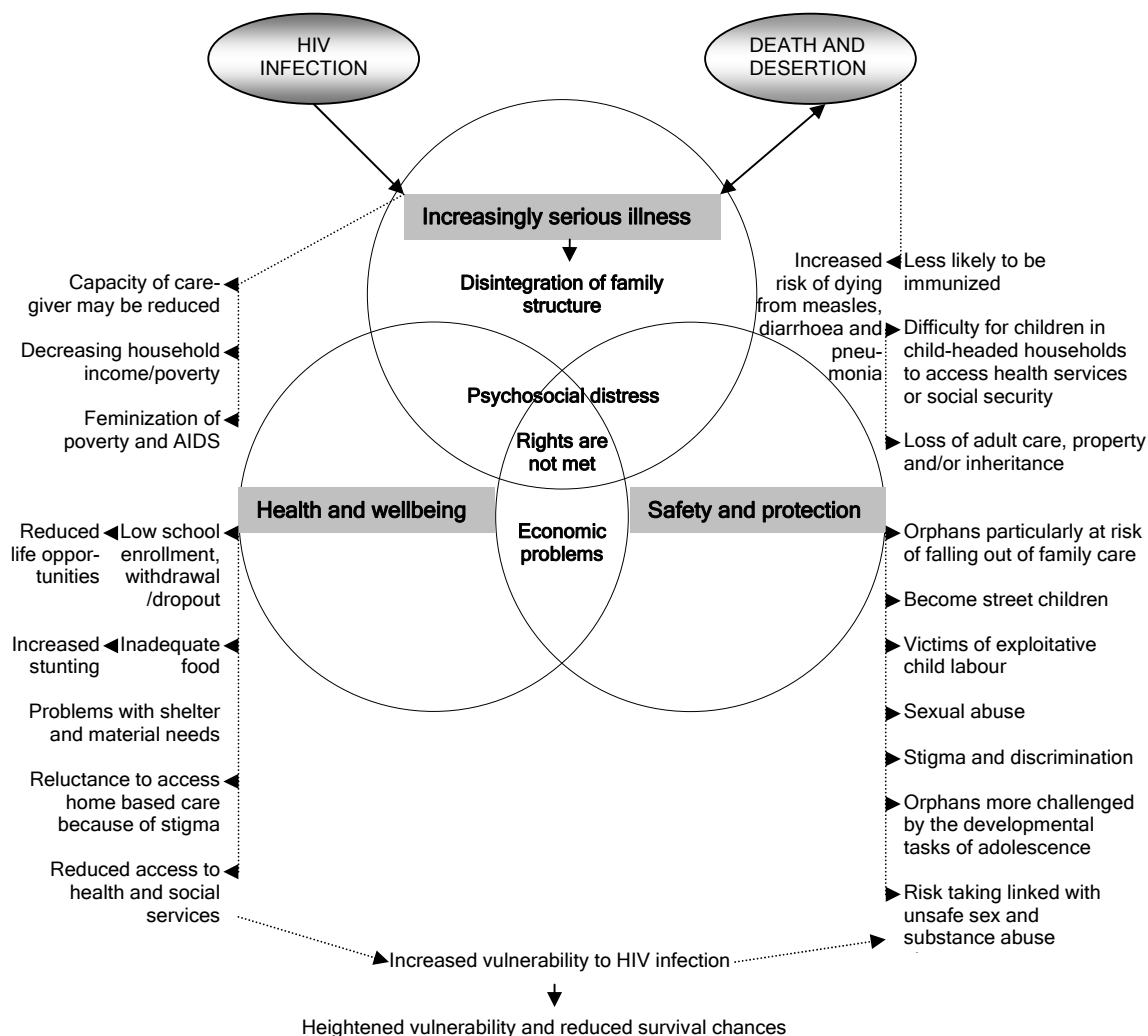

Figure 3.2: The impact of HIV/AIDS and resulting external factors and realities on the lives of children and families

Source: Adapted from Andrews, Skinner & Zuma (2006: 275) and Jackson (2002: 261).

In the next sections, Figure 3.2 is explained according to the environmental risk factors or stressors in South Africa that can influence HIV/AIDS-affected children's development, namely stigma and discrimination; poverty and unemployment; violence, crime, alcohol and drug abuse, and neighbourhood disorganisation

(e.g. physical deterioration and drug trafficking); multiculturalism; disintegration of family structures; and education (Department of Social Development, 2005b: 3; Dondenberg & Pao, 2005: 734; Ebersson, 2001: 41-4; Middel, 2001: 30-33). These environmental risk factors or stressors make it more pertinent that children living in South Africa will have to be resilient and self-efficacious to overcome adversities.

2.1.1 Stigmatisation and discrimination

Stigmatisation and discrimination occur in many settings: the family, local community, school, or healthcare facilities. Children are stigmatised by others because of experiences they have had or because they belong to a particular group. Stigmatisation is therefore based on beliefs and attitudes of others. Discrimination occurs when actions are taken (or not taken) on the basis of a stigmatising belief (*International HIV/AIDS alliance*, n.d.: 1 of 4).

Grieving children, who have lost their primary caregiver(s) due to HIV/AIDS, are often stigmatised and discriminated against by society (Beresford, 2002a: 6; Bhengu, 2002: 9; Cullinan, 2001: 11; Dondenberg & Pao, 2005: 734; Mallmann, 2003: 11-12; Skolnik, 2004: 3; Van Dyk, 2005: 273). The shame, fear, and rejection that often surrounds people affected by HIV/AIDS exacerbates the distress and social isolation experienced by these children, both before and after the death of their parent(s), and, on occasion they are even denied access to schooling and health care or their inheritance and property (AVERT [AVERTing HIV and AIDS], 2007: 2 of 8).

Often children who have lost their parents to AIDS are assumed to be infected with HIV themselves which further adds to the stigmatisation experienced by these children. This fact, together with the added assumption that their illnesses are untreatable, leads to reduced opportunities for these children. They are also denied the health care they may need (AVERT, 2007: 3 of 8). Other effects of stigmatisation and discrimination against HIV/AIDS-affected children may include (Dondenberg & Pao, 2005: 734-5; Jackson, 2002: 273):

- verbal and physical abuse of children;
- reduced self-esteem and confidence;
- withdrawal, depression, and other psychosocial problems; for example, aggression or disruptive behaviour;
- fear of disclosing information which may lead to children not getting the treatment they need; and
- running away from the place where they are experiencing stigmatisation and discrimination. This may involve their moving from rural to urban areas, which carries the risk of them ending up living on the street.

For HIV/AIDS-affected children, the development of a stable social bond to at least one caring adult may be crucial in replacing their shame and despair with optimism, hope, and faith. Connectedness to a variety of other caring persons outside the family could also provide continuing guidance and support.

2.1.2 Poverty and unemployment

Poverty and unemployment are considered the most common stressors that so many individuals living in South Africa face (Monson, Hall, Smith & Shung-King, 2006: 24-30; Kingdon & Knight, 2005: 1 of 4; Talbot, 2005: 1 of 4). Although poverty and unemployment has an influence on adults, it affects the lives of their children more directly (Ebersohn, 2001: 43; Middel, 2001: 31; Monson *et al.*, 2006: 19-23).

The impact of HIV/AIDS on children compounds vulnerabilities (poor education opportunities, hunger, malnutrition, neglect, and illness) that result from deep poverty (Beresford, 2002a: 6; Beresford, 2002b: 8; Bhengu, 2002: 9; *Business Times*, 2003: 12; Clarke, 2003: 6; Deane, 2003: 6; Department of Social Development, 2005a: 6). Additional risk factors associated with poverty that can perpetuate failure in school are (Mastropieri & Scruggs, 2000: 114-6):

- lack of health care
- low educational achievement of parents
- children born of substance abusers
- low birth-weight infants and weak prenatal care for those in low-income families
- children born of teen-age mothers

2.1.3 Violence, crime, alcohol and drug abuse, and neighbourhood disorganisation

The problems of unemployment, poverty, alcohol and drug abuse, and HIV are closely linked, and can threaten children's well-being. HIV/AIDS-related violence has many forms, from verbal harassment to physical assault to homicide. On the street, children are not guaranteed any form of safety, for violence and rape are used as weapons by gangs. Thus, (street) children often become victims of abuse (*Consortium for street children*, 2004: 1 of 2, Salaam, 2005: 5-6).

The destabilisation caused by violence, substance abuse problems, and other forms of disorganisation, such as domestic violence, child abuse and neglect, sexual abuse of women and children, and forced commercial sex, creates a vicious circle of isolation and desperation, which leads to increased risk-taking behaviour (e.g. teenage sex), and fuels the spread of HIV infection (Brummer, 2001: 1; Cohen & Epstein, 2005: 32; *Diamond Fields Advertiser*, 2003: 20; Kota, 2005: 5; Mchunu, 2003: 2; Stein, 2003: 6; Van Rensburg, 2004: 290). Hence, risk factors are cumulative and interactive, and tend to reinforce one another. Factors such as economic inequality, unemployment, poverty, racism and social disorganization may cause increases in crime rates and, concomitantly, lead to neighbourhood disorganisation (Camerer, 1996: 2 of 7).

2.1.4 Multiculturalism

South Africa is a truly multicultural society, with 11 national languages and many additional recognised ethnic and racial groups. While South Africa has seen tremendous change in the past decade, since the end of apartheid in 1994, it will take considerable time before an ideal goal of equality is reached (Dawes & Donald, 1994: 261; Middel, 2001: 33).

Children currently living in South Africa, therefore, do not only have to adapt not only to the changing environment because of HIV/AIDS and the other factors previously mentioned (cf. p. 45-6), but also to the effects of racism and multicultural changes that are taking place continuously.

2.1.5 Disintegration of family structures

The disintegration of family structures as a consequence of negative economic and social factors, as well as HIV/AIDS coincides with immense emotional trauma, confusion, and stress that affect both adults and children (Middel, 2001: 32). This could be related to the fact that, as Cook & Du Toit (n.d.: 2 of 20) explain,

[p]erhaps the most insidious aspect of HIV/AIDS is the capacity of the disease to sever those human bonds and social ties that children need to survive and thrive. Across Southern Africa, and particularly in South Africa, we are witnessing not only the reversal of developmental trends, but also the destruction of age-old patterns of traditional family, community, and social supports for children. In taking those members of society that are most crucial for children's immediate developmental needs (e.g., parents, relatives, teachers, nurses, social workers) AIDS slowly unravels the delicate web of relationships [assets] children need.

The profound impact that HIV/AIDS has on the family composition and welfare of family members often leads to the vulnerability of children and an increasing financial and emotional burden on traditional coping mechanisms, such as extended families who often lack the compassion and support that these children need (*Beeld*, 2004: 9; Graham, 2004: 8; Kalideen, 2003: 5; Kota, 2005: 5; Ntshingila, Gules & Pather, 2005: 8; *Star*, 2005: 5). In contrast with these reports, Smetherham (2004: 2) writes that extended families have shown remarkable resilience "with relatively few children falling through the cracks." Researchers from the Institute for Security Studies recommend that mechanisms should be put in place to protect and support extended families, yet the affects of the loss of primary caregivers in children's lives cannot be denied (Smetherham, 2004: 2). Mchunu (2003: 2) reports that, in most cases (before the death of parent(s), abuse of children was a result of the adult failing to accept their HIV status.

Unfortunately, in many cases, children who have lost their parents to AIDS, and who do not have extended family members to take care of them, are forced to drop out of school and become heads of households themselves (*Beeld*, 2004: 9; Bhengu, 2002: 9; Gallagher, 2004: 7; Madlala, 2003: 6). For these children,

closure and mourning of their parents' deaths are sometimes an unaffordable luxury because they are pre-occupied with survival (*Weekly Mail and Guardian*, 2004: 8). Being resilient with a strong sense of self-efficacy in the face of these added stressors holds an even greater challenge for these children.

2.1.6 Education

Schools could function as an important protective factor in the lives of HIV/AIDS-affected children because they are supposed to be places where children can learn problem-solving and academic skills that may contribute positively to their ability to deal with risk situations and stress. Schools can also provide children with a safe and structured environment, the emotional support and supervision of adults, and the opportunity to develop social networks, thereby enhancing their resilience and sense of self-efficacy.

Educational organisations in South Africa, however, present a number of distinct challenges and stressors. Many HIV/AIDS-affected children are denied the right to education due to the effects of HIV/AIDS-related illness and death on their lives. In some cases, for children who do attend school, the school environment holds exposure to stigma, discrimination, sexual exploitation by teachers, and gender-based violence. Explicit forms of gender violence that can permeate school environments are sexual harassment, aggressive or unsolicited sexual advances, touching, groping, intimidation, verbal abuse, or sexual assaults (*Girls, HIV/AIDS and Education*, 2004: 2; Department of Social Development, 2005a: 7).

Furthermore, the HIV/AIDS pandemic, has a debilitating impact on the education sector as schools are robbed of critical human and economic resources. Substantial numbers of teachers are ill, dying, or caring for family members. Loss of teachers through HIV/AIDS has led to a drop in the quality of education because of overcrowded classes, limited resources, and the replacement of qualified teachers with untrained teachers and administrators, which has a negative effect on management of the education system. In some instances, schools were even forced to close as a result of AIDS-related deaths amongst teachers (*Girls, HIV/AIDS and Education*, 2004: 2; Middel, 2001: 31).

Thus, “[m]any of the adverse conditions with which schools have to cope reflect the broader social and economic ills of the society” (Bandura, 1997: 233). For schools to overcome these adversities, and to be effective and resilient, strong academic leadership by principals, high academic standards with a firm belief in students' capabilities and the support to fulfil them, mastery-oriented instruction that enables students to exercise control over their academic performances, good management of classroom behaviour conducive to learning, and parental support and involvement in their children's schooling, are needed.

3. COPING STRATEGIES, RESOURCES AND PROCESSES

The preceding section outlined some of the ways in which HIV/AIDS impacts on the lives of children. It is clear that the impact of HIV/AIDS alters the lives of children radically as they struggle to survive, cope, and come to terms with their desperate realities. The following sections will outline strategies employed to help children cope with the effects of HIV/AIDS on their lives, and elucidate how the development of children's coping capabilities is greatly influenced by their external and inner resources or assets.

3.1 Coping strategies

Although resilience is considered to be a human capacity nascent in all children, studies of resilience focusing on children indicate that some children show the ability to respond to adversity in ways that *promote* resilience, while others show a lack thereof (Dugan & Coles, 1989; Grotberg, 1995: 13-36). The following strategies employed by HIV/AIDS-affected children to survive and cope in their environment illustrate this precisely:

- **Taking on a variety of adult roles and responsibilities:** for example, doing agricultural work and household chores, looking after siblings, and caring for ill or dying parent(s) (more so than in the case of children living with healthy parents) (Beresford, 2002a: 6; Jackson, 2002: 262).
- **Turn to fellow youths for personal and private matters:** on average, children are reported to go to friends, and, to a lesser extent, to aunts and uncles, for help, advice, or information on things they do not know (Tjaronda, 2005: 1).
- **Taking responsibility for (household) livelihood:** may involve reducing expenses on healthcare and education (dropping out of school), spending money mainly on things needed to survive (e.g. food), while some children take on informal employment, such as wage labour or farming activities for which they often lack the necessary skills, to increase household income (*Girls, HIV/AIDS and Education*, 2004: 2; Jackson, 2002: 262). Young girls often become involved in sex work, sell illicit brew, and wash clothing or clean houses to earn money (Cohen & Epstein, 2005: 32). Kota (2005: 5) reports that children from child-headed households also sell cool drinks, sweets, and chips to earn money to keep younger siblings in school and to buy their own food. Street children offer informal services, such as pushing shopping trolleys, washing cars, and guiding cars into parking spaces. They also take up semi-formal employment opportunities that include selling flowers or newspapers and sweeping pavements for shopkeepers. Less desirable ways of obtaining money are begging, gambling (playing a game called "tiekie-dice"), and providing sex or performing sexual acts imitated from pornographic videos (Donald & Swart-Kruger, 1994: 115).
- **Relocating or being relocated:** children may run away from home and often end up on the streets or are relocated to institutions or other family members in order to find an adult to take care of them (Beresford, 2002a: 6; Jackson, 2002: 263).

- **Being vulnerable to a number of risks:** such as substance abuse, child labour, criminal activity, HIV/AIDS infection, and sexual exploitation, including early marriage.

Even though these strategies help children to survive and cope, it remains imperative that their basic rights, for development, participation, protection, and survival are recognized, addressed and met (Department of Social Development, 2005a: 7-8; Mallmann, 2004: 141; Van Dyk, 2005: 270-1). Also, “although prevalence rates are expected to plateau and death rates should begin to decline with the national roll out of antiretroviral therapy, the numbers of children who are already affected is large and will continue to grow for a number of years” (Department of Social Development, 2005a: 6). Organisations, institutions, and communities are challenged continually to employ resilience building mechanisms and strategies to reduce and fight the impact of the epidemic, not only on the lives of children, but also on the larger ecological context (cf. Figure 2.4). These children need a supportive environment to ensure that structures are in place for future guidance, support, healthcare, education, development, protection, and life success. Affirming this, Carnegie (2003: 3 of 6) states:

It is vital that programmes that seek to strengthen children's resilience also address the issue of their environment. This includes the emotional, social and practical support they receive in their immediate environment from family, peer groups and neighbours, as well as support from community-based organisations, faith-based organisations, schools and health services, which need to be accessible and welcoming to children. Children also need a supportive environment at the national level to ensure that policies, legislation and structural support are in place to support and protect children.

The Search Institute's attempt at capturing these elements, in view of intervention strategies and programmes, can be traced in the developmental asset framework. The assets shown in Table 3.1 “reflect broad conceptualizations about strength-based, positive child development that are rooted in explications of key developmental socialization processes of connection, support, regulation, autonomy, and competencies” (Sesma *et al.*, 2005: 282). The following sections are intended to provide a clear understanding of how these processes facilitate children's development and their ability to cope with environmental risk factors or stressors (cf. 2.1, p. 44-9).

3.2 Sources

Looking into coping mechanisms is important but complex. The previous sections indicate clearly that internal resilience strengths or assets that facilitate a child's ability to cope with adversity should be viewed as part of a dynamic and contextual process that changes, develops, and unfolds over time. Supporting this notion, Schunk (2001: 127) maintains that “[h]uman functioning involves reciprocal interactions between behaviours, environmental variables, cognitions, and other personal factors.

From this theoretical perspective, children's functioning is viewed as the product of a dynamic interplay of personal, behavioural, and environmental influences. This interplay underlies Bandura's conception of *reciprocal determinism* (cf. Figure 3.3).

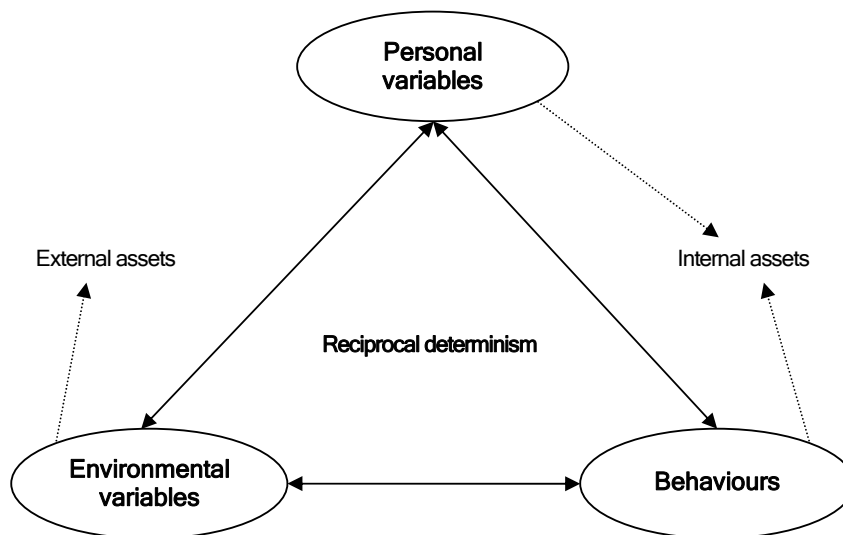

Figure 3.3: Triadic model of reciprocal interactions in human functioning

Source: Adapted from Schunk (2001:126).

Personal factors, behaviour, and environmental influences thus create interactions that result in a *triadic reciprocity*. The triad implies that the way in which children interpret the results of their own behaviour informs and alters their environments and the personal factors they possess. In turn, personal factors inform and alter subsequent behaviour (Pajares, n.d. 1 of 10). Figure 3.4 illustrates this process.

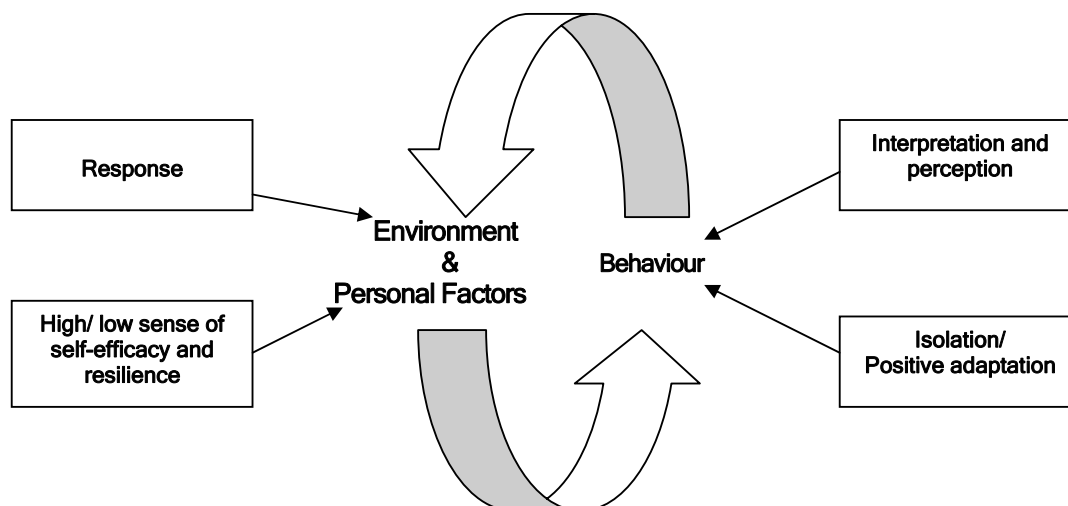

Figure 3.4: Reciprocal interactions in human functioning

Source: Based on Pajares (n.d.: 1 of 10), Schunk (2001: 126) and Steinberg & Belsky (1991: 5).

For example, a shy child A asks child B to play. Child B refuses. Child A interprets this as rejection and concludes that other children dislike him. Child A retreats to a corner and makes no further overtures of friendship. Other children respond by ignoring child A. Child A feels even more rejected and spends more time in the corner. The child has isolated himself and perceives other children's behaviour in a way that reinforces his feelings of rejection. In a converse reaction, Child A shrugs off the initial rejection and asks other children to play until a willing partner is found. In this way, the child resiliently shapes the events that affect his life (Steinberg & Belsky, 1991: 5).

Based on the transactional mechanism explained previously and the model in Figure 3.3, this investigation will follow an ecological, transactional systems approach to elucidate how children change constantly cognitive and behavioural efforts to manage specific external and internal demands - to learn to cope effectively with stress, pressure and everyday challenges, rebound from disappointments, mistakes, trauma and adversity, to develop clear and realistic goals, solve problems, interact comfortably with others, and to treat themselves and others with respect and dignity; in other words, to be resilient.

3.2.1 External sources (Environmental variables)

External assets identify important roles that families, schools, congregations, neighbourhoods, and youth organizations can play in promoting healthy development. To reiterate, many communities and international

organisations and institutions have responded to the growing crisis by funding and establishing orphanages, children's villages, or other group residential facilities to care for children affected by the epidemic. According to Guest (2003: 11) and *The framework for the protection, care and support of orphans and vulnerable children living in a world with HIV and AIDS* (Gulaid, 2004: 37), this strategy may seem a logical response, but it is not a viable solution. Generally, such institutions fail to meet children's developmental needs. Research has shown that countries and children are better served by programmes that keep children with their community (*Children on the Brink*, 2004: 19, Dunn, 2004: 3; International Social Service & UN Children's Fund [UNICEF], 2004: 6, Tolfree, 2003). The suggestions are that orphans should be cared for in family units through extended family networks, foster families and adoption, and that siblings should not be separated. Subbarao & Coury (2004: 19), Madlala (2003: 3), Salaam (2005: 11), and Van Dyk (2005: 269), however, mention that orphaned children are often exposed to mistreatment (abuse, neglect, and exploitation) by their foster family and extended family members. Thus, whether children are placed in the care of foster parents or extended family members to enable them to remain within their community, or, alternatively, in institutions, both environments hold adversities and difficulties that challenge these children's ability to cope and survive. Also, irrespective of the environment these children find themselves in, overwhelming feelings of grief, loneliness, stigma, and guilt associated with HIV/AIDS remain a part of their lives.

Intervention aids and strategies that are employed by community initiatives to enable HIV/AIDS-affected children to strengthen their coping skills for their own survival and continued development through the illness or loss of a parent, or that are aimed at building resilience and protecting the rights of these children, include:

- **The use of memory boxes:** a box filled with tangible reminders of the children's lives; for example, letters, pictures, objects from their home, such as a teaspoon or stones from the garden, and things given to them by their parents before they were orphaned, to help children prepare for the death of a parent, to comfort children through the sadness of losing their parent(s) after death, and to retain a sense of family identity (Clarke, 2002a: 10; 2002b: 6; Deane, 2004: 8; Denis, 2001: 23-5; Frohlic & Murphy, 2000: 238; Jackson, 2002: 272; Mallmann, 2003: 41; Nullis, 2004: 7).
- **Art:** children paint pictures of what they have witnessed and experienced, before and after the death of their parents. Engaging in creative activities helps children to come to terms with their loss and to deal with feelings of anger, guilt, rejection, and grief. Being able to talk about what they have painted helps to facilitate the healing process and address the "culture of silence" surrounding HIV/AIDS (Bhengu, 2002: 9; Carnegie, 2003: 1 of 6; Clarke, 2002a: 10; Naidoo, 2001: 7).
- **Touch:** is a basic human need. A lack thereof can be detrimental to a child's development, self-worth and future relationships. Therefore, volunteers (working at Ethembeni Home) provide children with physical touch to foster a sense of trust, acceptance, safety and security in these children (Smith, 2001: 3).
- **Groups and clubs:** intervention programmes, for example, "The Education for Life Programme," encourages children to join different clubs that form part of the programme. These clubs provide children with the opportunity to learn about health, child development, and basic survival. Club membership and group work with children challenges them to look at behaviour change from an early age, helps to foster

a sense of identity and belonging or connectedness in children, while children can provide one another with further support within the group. By helping others, children may gain a sense of resourcefulness and self-esteem. Clubs also enable children to share their emotional and psychological problems with adults. Club membership further provides access to training and small grants for income generating activities such as the rearing of goats (Carnegie, 2003: 4 of 6; Thom, 2001: 23).

- **Games:** The “Magical AIDS Journey” is a board game designed to give children affected by HIV/AIDS something practical to use to help them come to terms with the disease by getting in touch with their emotions through play and talk (Van Eyssen, 2004: 6).

These interventions cover the external assets, listed in Table 3.1, and reflect the positive experiences HIV/AIDS-affected children receive from external structures, relationships, and activities that create a positive environment for children’s development. Interventions based on these external assets foster resilience by providing opportunities for support and empowerment, setting boundaries, and communicating expectations, as well as the positive and constructive use of time. Communities’ responsibility for children does not end with the provision of external assets. It is imperative that caring adults make a similar commitment to nurturing the internal qualities of children affected by HIV and AIDS.

3.2.2 Internal sources (Personal factors)

The internal assets (cf. Table 3.1) identify characteristics and behaviour that reflects the positive internal growth and development of children. These assets are about positive values and identities, social competencies, and commitment to learning that fosters children’s ability to cope effectively with adversity.

Internal asset qualities, listed in Table 3.1, guide thoughtful, positive choices, and create a sense of centeredness, purpose and focus in children’s lives. In turn, these asset qualities help children to be better prepared for situations in life that challenge their inner strength, confidence, and ability to deal with a crisis. For children affected by HIV/AIDS, this wisdom is important as it will help them to make responsible decisions about the present and future. Fundamental underlying internal sources and processes that facilitate positive behaviour, development, and the ability to make responsible future decisions are explored in the next sections.

3.2.2.1 Efficacy beliefs

As noted in the previous chapter, and as stated by Harvey & Delfabbro (2004: 4), “all resilience research shares the basic assumption that almost all people [children] are subject to adversity and stressors, and that there are potentially many factors that can contribute to how they deal [or cope] with these experiences.” Similarly, Bandura (1994: 81) believes that people can and regularly do overcome seemingly insurmountable difficulties, but further argues that the key ingredient is self-efficacy (Van Slambrouck, 2005: 2 of 4).

Self-efficacy can be defined as the beliefs children have in their own capabilities, and the confidence they show in their ability to mobilise the motivation and cognitive resources necessary to execute a specific course of action within a given context. These beliefs are learned standards reinforced by sources such as modelling, mastery, persuasion, or beliefs about their capabilities to produce effects (Bee, 1989: 330; Bandura 1994: 71; Greene & Conrad, 2002: 46; Luthans & Youssef, 2004: 20; Schunk, 2001: 129). These beliefs and expectancies are considered to “form the core of what may be called personality [a child’s overall pattern of character, behavioural, temperamental, emotional and mental traits]” (Bee, 1989: 330; Olds & Papalia, 1992: 53).

This definition of self-efficacy underpins the resilience theory discussed in Chapter 2 (cf. 4.3, p. 24) in that resilient children engage in transactional processes or selectively perceive their environment, and seek role models which help them to transform a high-risk environment into a more protective environment. Although specific aspects of personality, such as temperament, or a child’s basic style of reacting (adapting) to situations, might be inborn or inherited, at least in part, many children may change their behavioural style, apparently reacting to special experiences or parental handling (Papalia & Olds, 1992: 58). This denotes the fact that personality is complex and cannot be ascribed solely to either environmental influences or heredity. Considered in part as an inner strength, it is nevertheless important to re-emphasize that self-efficacy is not a fixed personality trait.

Feasible and imperative reasons for Bandura’s argument may be that the greater the internal resources and self-efficacy beliefs available to children the more comprehensive their coping mechanisms will be, while beliefs of personal efficacy can shape the course lives take by influencing the types of activities and environments children choose (Bandura, 1994; Cove, Eiseman & Popkin, 2005: 2; Hamill, 2003: 118). Thus, children’s beliefs in self-efficacy play a *key role* in determining their futures and competence.

Some children may recover their sense of efficacy quickly after a setback or exposure to adversity, whereas others may lose faith in their capabilities. The determinant is perceived efficacy. Self-efficacy, perceived in terms of resilience as a process, means that children develop by persevering, accumulating small successes in the face of failures, setbacks, and disappointments (Bandura, 1986: 434; 1994: 71-2; Wolin & Wolin, 1999c: 1 of 1). It is the combination of positive dispositional characteristics, personal coping strategies, and beliefs about personal efficacy that contribute to individual resilience. Figure 3.5 shows how resilient children may draw from internal strengths and self-efficacy as core resilience strength in their efforts to cope and deal with adversities.

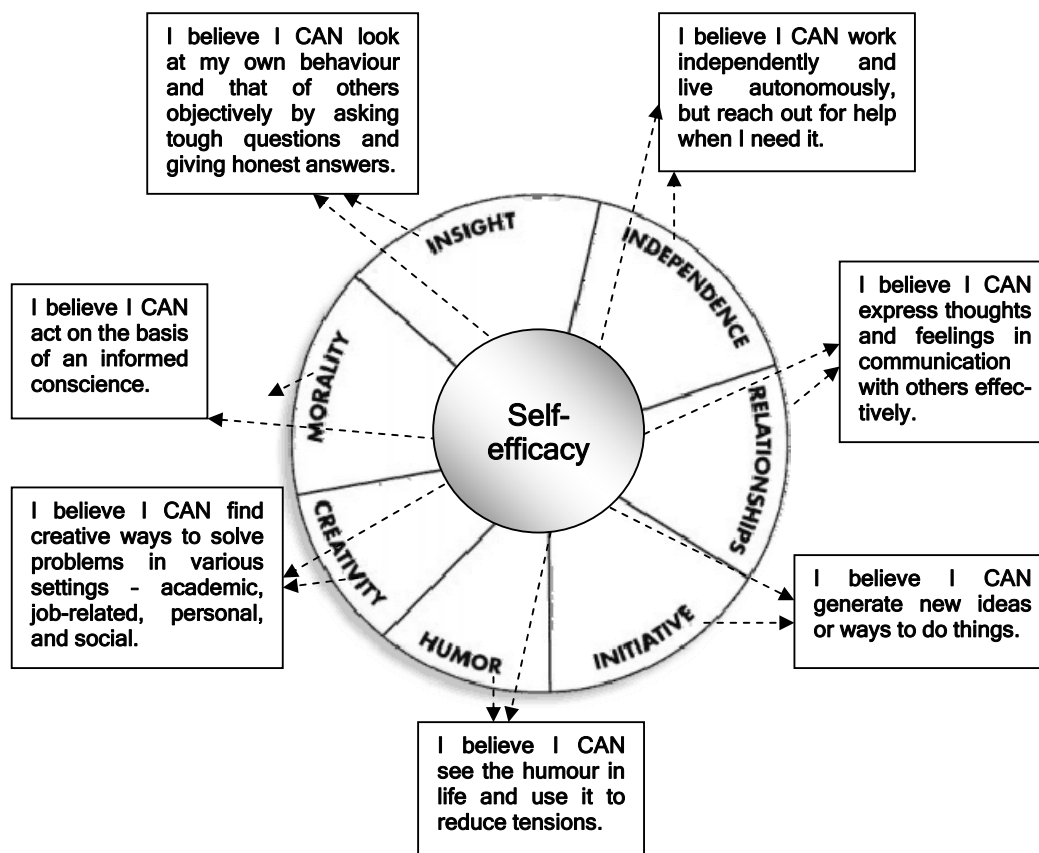

Figure 3.5: Self-efficacy and vocabulary of resilience strengths

Source: Based on Grotberg (1995: 9), Van Slambrouck (2005: 2 of 4) and Wolin & Wolin (1999d: 1 of 1).

Bandura (1986: 395) mentions that "[p]erceived self-efficacy contributes to the development of subskills, as well as draws upon them in fashioning new behavior patterns." As children build on and develop these inner developmental asset-related traits (shown in Figure 3.5), they construct a strong internal locus of control. In turn, this may contribute to their ability and capacity to be resilient.

An efficacious outlook on life produces feelings of personal accomplishment, and reduces stress while lowering vulnerability to depression, whereas children with low self-efficacy easily fall victim to stress and depression. Because they view insufficient performance as deficient ability, it does not require much failure for them to lose faith in their capabilities.

On the other hand, high assurance of children's capabilities fosters interest and deep engrossment in activities (Bandura, 1994: 71). Further differences (Bandura, 1994: 71) between characteristics of children with a strong sense of self-efficacy and children with a lack thereof can be compared as follows:

TABLE 3.2: Resilience and self-efficacy in children

Strong sense of self-efficacy	Lack of sense of self-efficacy
<ul style="list-style-type: none"> • Resilient children approach difficult tasks as challenges to be mastered rather than as threats to be avoided; • they set themselves challenging goals and maintain strong commitment to them; • they heighten and sustain their efforts in the face of failure; • they quickly recover their sense of efficacy after failures or setbacks • they attribute failure to insufficient effort or deficient knowledge and skills which are acquirable; and • approach threatening situations with assurance so that they can exercise control over them. 	<ul style="list-style-type: none"> • Non-resilient children shy away from difficult tasks which they view as personal threats; • they have low aspirations and weak commitment to the goals they choose to pursue. • they slacken their efforts and give up quickly in the face of difficulties; • and are slow to recover their sense of efficacy following failure or setbacks • they dwell on their personal deficiencies, on the obstacles they will encounter, and all kinds of adverse outcomes; and • when faced with difficult tasks, they lack the ability to concentrate on how to perform successfully.

Source: Based on Bandura (1994: 71).

This table indicates that children's efficacy beliefs influence courses of action, effort, perseverance in the face of obstacles and failures, and resilience to adversity. Self-efficacy beliefs also determine whether children's thought patterns are self-hindering or self-aiding, the level of stress and depression they experience in taxing situations, and the level of accomplishment realized (Bandura, 1994: 71; Valiante, n.d.: 1 of 5). This is evident, in the underlying principles and research findings of the Penn Resilience Programme (PRP). These principles and findings illustrate how cognitive behavioural patterns influence children's resilience (Reivich, Gillham, Chaplin & Seligman, 2005: 227-232). In the Roberts, Kane, Thomson, Bishop & Hart (2003: 622-628) study, for instance, findings showed that the PRP significantly reduced anxiety symptoms in rural school children. Resilience is then the quality conveyed through feelings, thoughts, and behaviours that facilitates the ability to overcome.

Possible underlying mechanisms that characterise the interaction between efficacious children and their environment are:

- **Compensation:** An example of a compensatory factor that can counterbalance risk factors is reading. Self-efficacy is thought to be one of the most important components of reading motivation. Being an engaged reader is correlated strongly with reading achievement. A strong sense of efficacy or the ability of a child to judge his own capabilities in regard to a task and engagement in reading can compensate for low achievement due to socio-economic status or parents' educational level. Thus, children who become engaged readers can thereby overcome the disadvantages of risk (Colker, 2005: 1 of 3).
- **Challenge:** When children are faced with challenging experiences or situations which they are able to master and overcome, successes build a robust belief in their personal efficacy (Bandura, 1994: 71).

Thus, previously stressful or challenging events can enhance self-efficacy. This enables children to face new challenges with more competence and belief in their abilities. Failures can undermine children's sense of efficacy, especially if failures occur before a sense of efficacy is firmly established. An ability to overcome failure, obstacles, or adversity through perseverance, signifies a resilient sense of self-efficacy. Hence, some difficulties and setbacks may serve a useful purpose in teaching that success usually requires sustained effort. Children who experience only easy successes come to expect quick results and are thus easily discouraged by failure (Bandura, 1994: 71-2; 1995: 3).

- **Protection:** Deater-Deckard, Ivy, & Smith (2005: 53) view high self-efficacy (and self-esteem) as effective protection against the harmful effects of a wide variety of risk factors. Children's sense of self-efficacy may enhance their accomplishment and personal well-being in many ways (Bandura, 1994: 71). Children are more adept at planning coping strategies, as well as evaluating and changing strategies that are not working well, if they believe that they are valuable to others and can control their circumstances (Deater-Deckard *et al.*, 2005: 53). In this instance, a strong sense of self-efficacy may be considered as a protective factor in the lives of children.

It remains important, however, for a child with an efficacious outlook to maintain a *realistic* view of his or her capabilities coupled with a belief that he or she has the potential to grow or develop and achieve success within his or her capacity, potential and age-appropriate stages of development. Consistent with this argument, Anthony & Cohen (referred to by Dent & Cameron, 2003: 3) state that resilience is normal development under the most difficult and challenging conditions. Importantly, the focus is not so much on the skills children possess, but rather on what they can do with whatever skills or assets they have (Bandura, 1986: 391).

Children's beliefs concerning their efficacy, as distinguished by Bandura, (1986: 259, 400, 519-20; 1994: 72; 1995: 4), Benard, (2004: 2 of 8), Bentzen (2005: 45), Lacter (2005: 2 of 4), Luthans & Yousseff (2004: 23) and Schunk (2001: 127-8) can be developed by four main influences:

- **Mastery experiences:** Developing a sense of efficacy through mastery experiences involves acquiring the cognitive, behavioural, and self-regulatory tools for creating and executing appropriate courses of action to manage ever-changing life circumstances. Play as such is sometimes fuelled by children's drive for mastery and their need to challenge others.
- **Vicarious experiences:** When children see individuals similar to themselves succeed by persevering, their own beliefs that they too possess the capabilities to master comparable activities are strengthened. Seeing others fail may lower or undermine the observers' trust in efficacy. Factors that make children more sensitive to vicarious influence are uncertainty about their own capability and little prior experience of criteria by which ability is evaluated. Therefore, social comparative processes figure prominently in self-efficacy appraisals.
- **Social persuasion:** This involves strengthening children's beliefs that they have what it takes to succeed, through verbal persuasion for example. High expectation conveys a belief in children's innate resilience. Thereby strengths and assets are highlighted instead of problems and deficits.

- **Physiological and emotional factors:** Children rely partly on physiological factors in judging their capabilities. In activities involving stamina and strength, fatigue, aches, and pains are judged as signs of physical debility. Stress reactions and tension are interpreted as signs of vulnerability to poor performance. A positive mood enhances perceived efficacy, whereas a despondent mood diminishes it.

It is important to emphasise that children are not shaped passively by environmental forces or driven by impulses simply to react to their environment. Rather, children are self-organising, proactive, self-reflecting and self-regulating beings that can (learn to) exert behavioural influence over their environment (Bandura, 1994: 75; Pajares, n.d.: 1 of 10).

3.2.2.2 Symbolizing

Cognition plays a fundamental role in children's capability to construct reality, self-regulate, encode information, and perform behaviours (Chung & Ro, 2004: 116; Schunk, 2001: 127; Steinberg & Belsky, 1991: 17). To comprehend how human behaviour develops, it is critical to understand how children process and interpret outcomes cognitively.

Typically, self-efficacy improves when children interpret outcomes as successful. When children interpret outcomes as failures, self-efficacy declines. Self-efficacy beliefs, behaviour changes, and outcomes are thus highly correlated. Hence, self-efficacy is considered to be a dependable predictor of behaviour. Particularly in psychology and education, self-efficacy has proven to be a more consistent predictor of behavioural outcomes than any other motivational construct (Pajares, n.d.: 8 of 10). For children, it is clearly belief in their capabilities that is important and not only a matter of whether they are capable of performing a task or not.

Capabilities to symbolise, plan alternative strategies (forethought), learn through vicarious experience, self-regulate, and self-reflect provide children with the cognitive means to determine their own future. "[O]bserved behaviours can be reproduced only if they are retained in memory, a process made possible by the human capability to symbolize" (Pajares, n.d.: 3 of 10).

The capability to symbolise is fundamental to cognitive development. Symbolic capabilities enable children to extract meaning from their environment; to process and transform transient experiences into internal models or guides for action, to solve problems, and support forethoughtful courses of action. Symbolic capabilities also enable children to gain new knowledge by reflective thought, communicate with others at any distance in time and space, alter and adapt to their environment, and create ideas that transcend their sensory experiences (Bandura, 1986: 18). Hence, for Bandura, symbols are the vehicle of thought.

Piaget refers to these mental representations and patterns of action that structure a child's knowledge as *schemes*. For example, a baby's scheme of a teddy bear is that of something that can be hugged and chewed. The child's knowledge of the world is tied to sensing and doing. He does not yet know things in the

abstract, as older children do. Recurring patterns of actions performed on objects (shaking, mouthing, smelling, or biting) organise in the child's reality (Papalia & Olds, 1993: 30).

The child uses schemes in different ways in an attempt to adapt to his world, to find meaning, and to understand. The process of incorporating new information into existing schemes is called *assimilation*. This means that children notice an object, person, or experience; recognise it; take it in; and link it up with previous experiences or categories. A child may learn that an object is hot and that it should not be touched. In time, the child learns that there are also other objects to which the same rule applies. The child then assimilates all this new information into a scheme consisting of a certain group of objects that are forbidden to touch (Papalia & Olds, 1993: 30; Steinberg & Belsky, 1991: 19-20; Steinberg & Meyer, 1995: 21-22). Thus, assimilation is an active process. It involves selection and modification of information as it is assimilated.

Accommodation is a complementary process whereby children alter existing schemes to fit new information. For instance, the child may point to an object and the mother will respond by saying: "Don't touch!" The child then points to the object and says: "Hot!" The mother then explains that it is not hot, but should not be touched. The child is forced to accommodate his existing scheme of objects that should not be touched to suit this new information. A new, more sophisticated view of reality constitutes a new scheme. This change in thinking restores the child to a cognitive state of equilibrium or balance, in which all the various pieces of his knowledge again fit together. This process is known as equilibration (Bee, 1989: 227; Cowie & Smith, 1988: 217, 263, 278; Papalia & Olds, 1993: 30; Steinberg & Belsky, 1991: 19-20; Steinberg & Meyer, 1995: 21-22).

Bovensiepen (2002: 242-3) noticed that children and adolescents who have been exposed to traumatic experiences (child abuse, violence, deprivation or chronic physical illness) are not able to use their symbolic function adequately. Loss of symbolic function could be considered as a form of regression. With therapeutic intervention though, these children are able to recover and develop their symbolizing capabilities (Bovensiepen, 2002: 251).

Symbols are not only a vehicle for thought but may also function as a vehicle for introspection. Introspective capabilities, therefore, play a significant role in children's development: "For Bandura, a psychology without introspection cannot aspire to explain the complexities of human functioning" (Pajares, 2002: 2 of 10). Pajares (2002: 2 of 10) argues perceptively that "[i]t is by looking into their own conscious mind that people [children] make sense of their own psychological processes."

3.2.2.3 Learning

The learning process is fundamental to resilience (cf. 4.6.2, p. 34). In the learning process, the mind, behaviour, and the environment all play a significant role (Schunk, 2001: 126, cf. Figures 3.3 and 3.4). Learning does not occur only through direct experience; children can also learn new behaviours through the process of observing others and noticing the consequences of their behaviour (Bandura, 1963: 2 of 9; 1986: 49; Bee, 1989: 330). As indicated before (cf. p.59-60), this process is referred to as *vicarious reinforcement*

and *vicarious punishment* (Bee, 2005: 17, 328; Bentzen, 2005: 45; Schunk, 2001: 129). Similar to Piaget's theory of adaptional process of development (cf. p. 35 and 60), Bandura formulates a four-step pattern which illustrates and explains an operant view of vicarious or observational learning (Huitt, 2004: 1 of 3):

- **Attention:** The child observes selectively the actions of an individual (model) in the environment.
- **Retention:** The child remembers what was noticed. In other words, the observation is coded symbolically and used as a guide for future action.
- **Reproduction:** The child produces an action that is a copy of what was noticed.
- **Motivation:** The environment delivers a consequence (reinforcement or punishment) that influences the probability that the behaviour will be emitted again.

Observational learning may also be more effective or motivating than direct experience, for a child does not have to go through trial and error. By observing others, children can witness the correct behaviour to achieve the desired outcome. There is no wasted effort, which is more efficient.

The process most used in observational learning is *modelling*. Children can often be seen modelling their parents in play. Children will imitate adults and then generalise. They will usually model a person of high status as opposed to a person of low status, or a person who possesses qualities they admire and capabilities they aspire too (Bandura, 1986: 344; Bee, 1989: 17; Pajares, n.d.: 7 of 10).

Perceived self-efficacy, or children's personal beliefs about their capabilities to learn or perform behaviours at designated levels, plays an important role in their learning and motivation. Children exercise influence over their own motivation, thought processes, emotional states, and patterns of behaviour through self-regulation (Bandura, 1994: 71; Steinberg & Meyer, 1995: 378). Viewed in terms of learning, self-regulation refers to learning that results from children's self-generated thoughts and behaviours that are systematically oriented toward the attainment of their learning goals.

From the outset of learning activities, children have goals. Children employ their sense of self-efficacy to attain their goals. They derive their efficacy from personal accomplishments, vicarious experiences, social persuasion, and physiological indicators (Bandura, 1994: 72, 81; Schunk, 2001: 127). Self-reflection allows children to make sense of their experiences, explore their own cognitions and self-beliefs, engage in self-evaluation, and to alter their thinking and behaviour accordingly. In turn, self-evaluations of learning progress sustain self-efficacy and motivation (Schunk, 2001: 140-2). These key points and others (cf. 4.7, p. 37-9) that denote the relationship between children and their environment from a developmental perspective are conceptualised in Figure 3.6.

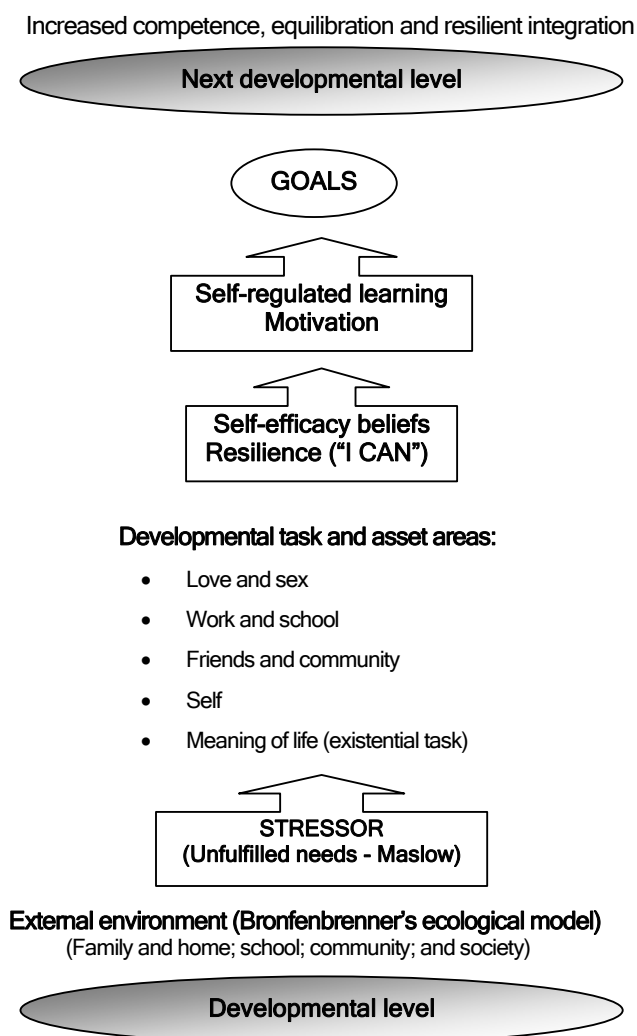

Figure 3.6: Developmental processes and key points

Sources: Based on Bandura (1994: 71), Bee (1989: 330), Manaster (1977: 13), Papalia & Olds (1992: 33-4) and Schunk (2001: 126).

The underlying protective processes (and constructs) that children draw on in their efforts to cope with internal and external demands will be explained in the next section.

3.3 Processes

Human functioning and behaviour (coping) are fuelled (by self-beliefs of efficacy) through four major psychological processes. These are: cognitive, motivational, affective and selection processes (Bandura, 1994: 72).

3.3.1 Cognitive processes

Most courses of human action are organised initially in thought. Thus, for explaining complex human behaviour, cognitive theory is imperative as it postulates that thoughts can regulate actions (Bandura, 1986: 15; 1994: 72).

A major function of thought is to enable children to predict or anticipate events, and to develop ways to control events that affect their lives. The types of anticipatory scenarios children construct cognitively and rehearse are shaped by their beliefs in their self-efficacy. The visualisation of success scenarios guides and supports performance, whereas visualisation of failure situations leads to self-doubt and a focus on what can go wrong. Efficacy skills require effective cognitive processing of information that contains many ambiguities and uncertainties (Bandura, 1994: 73). Bandura (1994: 3) explains cognitive processing as follows:

In learning predictive and regulative rules people [children] must draw on their knowledge to construct options, to weight and integrate predictive factors, to test and revise their judgments against the immediate and distal results of their actions, and remember which factors they had tested and how well they had worked.

Hence, cognitive processes involve thinking processes in the acquisition, organisation, and use of information. Children who doubt themselves, and are faced with managing difficult environmental demands under taxing circumstances, find it difficult to deal with these demands. These children become more and more erratic in their analytical thinking, and lower their aspirations, while the quality of their performance deteriorates (Bandura, 1994: 73).

For children to remain task-orientated in the face of pressing situational demands, adversity, failures, and setbacks requires a strong sense of self-efficacy and a resilient response. Bandura (1994: 73) maintains that this includes setting challenging goals and making good use of analytical thinking that encourages performance accomplishments.

3.3.2 Motivational processes

In essence, Bandura (1994: 71) defines motivation as activation to action. The level of children's motivation is reflected in their choice of courses of action and in the intensity and persistence of effort (Bandura, 1994: 71). Thus, it becomes clear that resilience and self-efficacy play a key role in motivation.

Bandura (1994: 73) identifies three different forms of cognitive motivators: causal attributions, outcome expectancies, and cognitised goals. Self-efficacy beliefs operate in each of these types of cognitive motivation (Bandura, 1986: 230; 1994: 73; Schunk, 2001: 126):

- **Causal attributions:** Highly efficacious children attribute their failures to insufficient motivation, whereas children who regard themselves as inefficacious attribute failure to low ability.
- **Outcome expectancies:** The motivating influence of outcome expectancies is governed by beliefs of efficacy as well as the likely outcomes of performance, and the value placed on these outcomes. Often, there are countless positive options that children do not pursue because they judge mistakenly that they do not have the required capabilities. The higher the outcome expectancy and the more valued the outcomes, the greater is the motivation to perform the activity.
- **Cognitised goals:** Motivation based on goal setting involves a cognitive comparison process. By making self-satisfaction a goal, children give direction to their behaviour and create incentives to persist in their efforts until they fulfil their goals. They are prompted to intensify their efforts by discontent with substandard performances and seek self-satisfaction from fulfilling valued goals.

Motivation, based on goals and personal standards, is governed by three types of self-influences: children's self-satisfying and self-dissatisfying reactions to their performance, perceived self-efficacy for goal-attainment, and the re-adjustment of personal goals based on their progress. Children's self-efficacy beliefs contribute to motivation in that they determine the goals children set for themselves, how much effort they expend, how long they persevere in the face of difficulties, and their resilience to failures (Bandura, 1994: 73).

3.3.3 Affective processes

Affective processes regulate emotional states and the elicitation of emotional reactions. Children's perceived efficacy to exercise control over stressors, and their belief in their ability to cope with threatening or difficult situations, plays a central role in anxiety management. Affective processes affect the level of motivation they will experience (Bandura, 1994: 73-4).

Children who believe they cannot manage threats experience high levels of anxiety. They dwell on coping deficiencies, view many aspects of their environment as fraught with danger, tend to magnify the severity of possible threats, and worry about things that rarely happen. This impairs children's level of functioning. Human systems are highly interdependent. A weak sense of efficacy to exercise control over stressors may,

for instance, have a negative impact on immune function. Conversely, the stronger the sense of self-efficacy, the bolder children are in taking on taxing and threatening situations (Bandura, 1994: 71; 74-5). Thus, anxiety arousal is increased or reduced by perceived coping efficacy and by perceived efficacy to control disturbing thoughts.

To achieve personal change (eliminating phobic or avoidant behaviour, anxiety and biological stress reactions, and creating a positive attitude), guided mastery and a variety of performance mastery aids can be used to facilitate a strong sense of coping efficacy in children. Measures taken when these strategies are used include (Bandura, 1994: 74):

- modelling feared activities first of all to show children how to cope with threats and to disconfirm their worst fears
- breaking coping tasks down into two subtasks of easily mastered steps
- performing feared activities together with a skilled person, further enables people to do things that they would resist doing by themselves
- using graduated time to overcome resistance. As coping efficacy increases, the time used to perform an activity is extended
- using protective aids and dosing the severity of threats also helps to restore and develop a sense of coping efficacy

After the child's functioning is fully restored, the mastery aids may be withdrawn to assess whether coping successes stem from personal efficacy or mastery aids (Bandura, 1994: 74). Once children have developed a resilient sense of efficacy, they can withstand difficulties and adversities without, or with reduced, adverse effects.

3.3.4 Selection processes

Bandura (1994: 75) argues that "by the choices they make, people [children] cultivate different competencies, interests, and social networks that determine life courses." Self-efficacy plays a significant role in determining and affecting the course of life paths through choice-related processes (Bee, 1989: 384). Newman (1996: 19; 26) believes that the following principles have a direct impact on efficacy and are important (also for children) in making choices and taking action to follow life courses:

- Determine what is wanted out of life, what self-knowledge is needed, how to live in alignment with one's own consciousness, and, finally, create a well-thought-out definition of personal success.
- Master skills to make wise, conscious choices on how children want to live their lives, then take wise, consistent action that supports those actions.
- Gain knowledge to produce desired results effectively.
- Gain knowledge to approach and deal with the problems, stress, setbacks, personal challenges, and opportunities in a calm, composed, and confident manner.

- Make full use of physical, mental, emotional, and spiritual strengths.
- Show resilience and foster the ability to remain focused on chosen goals.
- Develop the ability to practise self-care and to have positive thoughts.

Additionally, Bandura (1994: 75) states that “any factor that influences choice of behaviour can profoundly affect the direction of personal development.” The reason for this, he argues, is that certain competencies, values, and interests are continually promoted by the social influences operating in selected environments, long after the decisional determinant has had its initiating effect.

4. DEVELOPMENTAL PHASES

Viewed within the broader developmental context, the processes that children engage in and resources that they draw on to cope with, overcome, learn from, and be transformed by adversities and challenges (set by every stage of development), are illustrated in Figure 3.7.

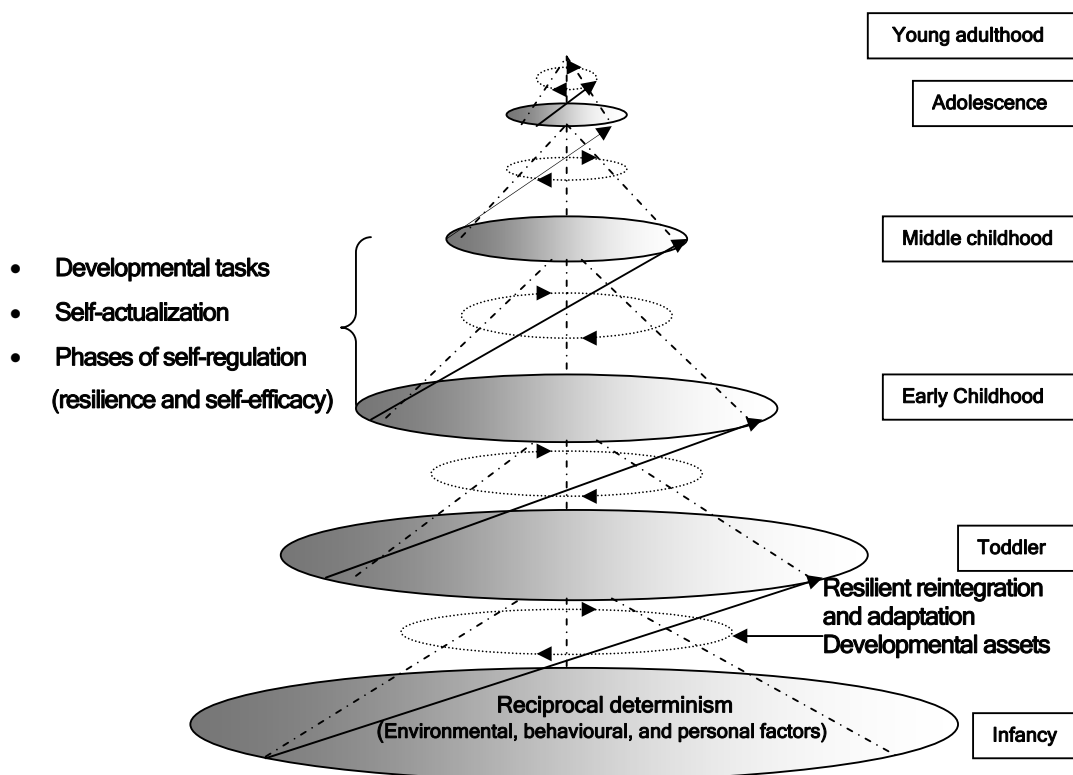

Figure 3.7: The development of personality traits across the life stages

Sources: Based on Bandura (1994: 71), Bee (1989: 330), McConnell (1974: 630), Papalia & Olds (1992: 6-7, 33-4) and Schunk (2001: 126, 142-6).

Each period of development brings with it new challenges for coping efficacy as different periods of life present certain types of competency demands for successful functioning. The judgement as to whether children are adapting well, and remaining competent, or are resilient at various points in their life span, is often made by reference to normative developmental tasks, that is, evaluations of how a child (or adult) is adapting based on pooled, generalized knowledge of human development (Greene & Conrad, 2002: 55). For instance, when a judgement of children's adaptation, resilience, or competence in the pre-adolescent phase (also referred to as middle childhood), is made, the following age-specific developmental tasks may be considered: continued physical growth, developing an understanding of rules and responsibility, developing healthy peer relations and family identity, developing skills for numeracy and literacy, increasing ability to express feelings, and improving problem-solving skills. Conversely, developmental risks associated with pre-adolescence are withdrawal, destructive and cruel behaviour to self or others, a lack of sense of morality and rules, and difficulty in learning (*Children on the Brink*, 2004: 16).

Greene & Conrad (2002: 55) however warn that, although some developmental tasks may be universal (for example, bonding and language development), many expectations for behaviour or milestones reflect mainstream popular culture. It is therefore important to bear in mind that other developmental tasks, for instance, the ability to express feelings, may not be inherent and identical for all children. Stages associated with developmental tasks should rather be thought of as flexible, shaped by family form, culture, and historical period. This viewpoint correlates with social cognitive theory in that children's behaviour is considered as an outcome of multiple and complex influences over time. Possible positive outcomes associated with the pre-adolescent phase, for example, are: developing a sense of competence through self-regulation, discovering pleasure in intellectual stimulation, being productive, and seeking success. A negative outcome associated with this age category is the development of a sense of inferiority (Steinberg & Meyer, 1995: 384; Winsler, 2003: 1 of 1).

The intention of the following sections is to investigate more specifically the resources and means by which children develop their competence and, by implication, their beliefs in efficacy and internal assets, through the adaptive and protective system of self-regulation. Social learning theory predicts that children learn ways of behaving vicariously through observation. According to social learning theory, if children identify with perpetrators of violence, they are likely to adopt these violent behaviours. It is imperative for these children to develop self-regulatory abilities and self-efficacy to refrain from negative behaviours, such as violence, crime, or drug abuse, and engage in positive activities to foster resilience and break the vicious circle of negative events that permeate their lives.

To be self-regulated is a psychological characteristic that is key to resilient behaviour, and means that children gain a set of skills related to increased control over their attention, emotions, and behaviour (Greene, 2002: 46). The process of self-regulation allows children to envision the future or set goals, and then regulate their behaviour and emotions so as to bring them about. Throughout their lives, children benefit from learning to self-regulate behaviour. Children with a strong self-regulatory ability are more liked by peers, have more self-esteem and confidence, are more independent, have better social and cognitive skills, do better academically, are better at handling stress and frustration during adolescence, and attain career success in adulthood (LeFebvre, 2003: 2).

The capacity to self-regulate matures as children grow. Competence develops initially from social sources (the external environment) and shifts subsequently to self-sources (internal) in a series of levels (cf. Figure 3.8). Although there might be some overlap, the first two levels (observational and emulative) rely primarily on social factors. By the second two levels (self-controlled and self-regulated), the source of influence shifts to the child (Schunk, 2001: 142).

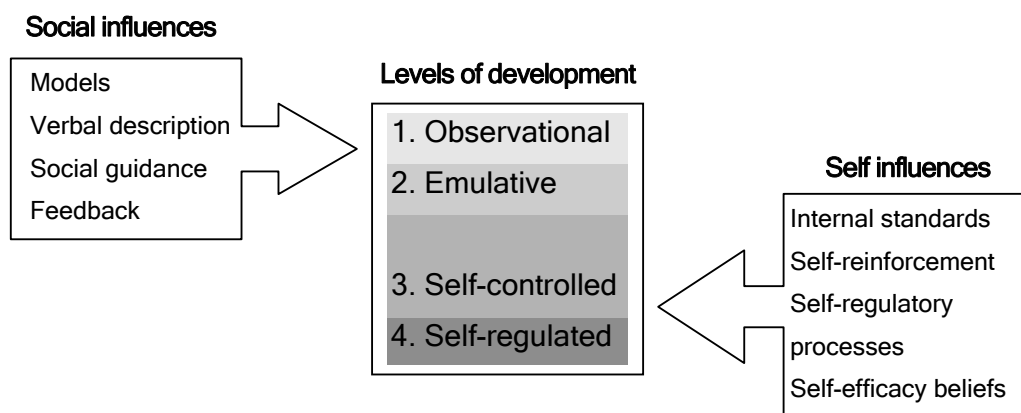

Figure 3.8: The development of self-regulatory competence

Source: Adapted from Schunk (2001: 143).

At the observational level, children acquire skills and strategies from social modelling, teaching, task structuring, and encouragement. At this level, children need practice as well as feedback to begin to develop skills. The emulative level is attained when the child's performance reaches the form of the model's performance. The child does not merely copy from the model, but emulates the model's general pattern or style. With the first two levels, children start to internalise learned skills and strategies drawn from social sources. This process increases with the shift to the third and fourth levels (Schunk, 2001: 143).

From the next two levels, the focus shifts to sources that reside primarily within the child. When children reach the third level, they are able to show the capability to use learned skills or strategies independently when performing related tasks. The final self-regulated level allows children to initiate the use of skills and strategies, incorporate adjustments based on features of the situation, and maintain their motivation through personal goals and a sense of self-efficacy for attaining those goals. Children are thus able to adapt their skills and strategies systematically as personal and contextual conditions change. It is important to bear in mind that, although self-regulated children may use social resources less frequently, they do continue to rely on them nonetheless (Schunk, 2001: 143-4).

Thus, throughout these different levels of self-regulatory development, children draw on resources or assets from their social context or environment to varying degrees and in different ways. Hence, role models, teachers, coaches, and tutors play a key role in children's self-regulatory development. They influence behaviours (resilience), and personal factors (self-efficacy) which, in turn, affect the social environment. The next discussion will explore the three cyclical phases that seem to emerge in the acquisition or development of self-regulation skills.

4.1 Forethought phase

Children's capacity to learn from models depends on various developmental factors (age, judgmental ability, ability to process information, capability to use various memory strategies, or capacity to encode modelled events). Younger children find it difficult to distinguish relevant from irrelevant cues and to attend to models for extensive periods. With development, the ability to process information improves as children develop a broad knowledge base and improve their capability to use various memory strategies. The way in which children encode modelled events is also related to age. Young children encode modelled events in terms of physical properties, whereas older children tend to represent information symbolically; for example, in terms of language. However, observed information cannot be performed if children lack the requisite physical capabilities. The development of translating information in memory into action, comparing performance with memorial representation, and correcting information as necessary, leads to improved production. Young children are motivated by immediate consequences. As children mature, they increasingly tend to perform modelled actions that they find satisfying internally (Schunk, 2001: 144).

With regard to goals, young children find proximal (short-term) goals and activities planned around short blocks of time more manageable as they have short time frames of reference, and may not yet be fully capable of presenting distant outcomes in thought. As children develop, they are able to improve their capabilities to represent long term outcomes in thought and to subdivide mentally a distant goal into short-term goals (Schunk, 2001: 145). Viewed in terms of resilience and self-efficacy, children develop their cognitive abilities to gain information, set goals accordingly, and persist with belief in their capabilities to reach their goals so as to fulfil their purpose and vision in life.

4.2 Performance control phase

Higher levels of cognitive development and experience in making comparative evaluations determine the ability to use comparative information effectively. With young children, the "self" dominates their cognitive focus and judgements. Children have the ability to evaluate themselves by comparing themselves to other children, but may not do so automatically. As children develop, they show increasing interest in social comparison, and they use this information to form self-evaluations of their capabilities. Younger children's behaviour is affected more by direct adult social evaluation. As children approach adolescence, peer performances start to influence their performances on motor and academic tasks (Schunk, 2001: 145).

The meaning and function of information gathered from social comparison also changes with development and, even more significantly so, after entering school. Pre-school children's social comparisons involve similarities and differences between themselves and others primarily without self-evaluation, but changes to a concern for how to perform tasks. After entering school, children's interest in how well peers are doing and comparative information is used for motivation and to evaluate their own capabilities (Schunk, 2001: 145).

Young children contribute the principal cause of outcomes to effort, which is intertwined with ability. A distinct conception of ability emerges with development. Effort as a causal factor becomes less important and ability attributions become increasingly important influences on self-efficacy (Schunk, 2001: 145).

4.3 Self-reflection phase

Apart from children's capacity to learn from models and the ability to use comparative information correctly, the process of comparing performances with goals in determining progress is also affected by developmental factors. Over- or underestimation of capabilities can easily occur. When children learn some component subskills of a task, but not others, a false sense of competence may be instated, and progress judgments are then likely to be made. Children may solve problems accurately, but may not have a sense of efficacy regarding their ability to find solutions for they do not know if their answers are correct. Therefore, progress feedback becomes critical (Schunk, 2001: 144).

Because children do not self-evaluate progress and keep goals in mind automatically, it is helpful to make goals explicit. Thus, children can be provided with opportunities for self-evaluation of progress and capabilities. In turn, this may strengthen their sense of self-efficacy (Schunk, 2001: 145).

5. SUMMARY

The interaction between children and their environment is characterised by the development and use of personality traits or inner strengths (self-efficacy) that enable them to sustain the effort needed to succeed amid contextual realities that hold many impediments, adversities, setbacks, frustrations, and inequities. This chapter focused more specifically on the theories of Piaget and Bandura to investigate the relationship between internal (cognitive) and external processes (of reinforcement) that occur as children develop. These processes are rooted in the various developmental asset categories outlined in Table 3.1. The interaction between these two domains (external and internal) serve to meet children's developmental needs for belonging, safety, respect, love, mastery, challenge, power, and meaning.

Perceived self-efficacy is considered as a key internal asset, and is concerned with children's beliefs in their capabilities to exercise control over their own functioning and over events that affect their lives. Beliefs in personal efficacy affect life choices, level of motivation, resilience to adversity, quality of functioning, and vulnerability to stress and depression. This chapter places self-efficacy, as a pivotal factor of resilience, against the backdrop of social cognitive theory, which postulates that children's development of personality traits as well as their life courses are influenced by the interaction of behaviour, personal variables, and the environment (cf. Figure 3.9). Focus on, and inclusion of, the social context or external environment in the study of HIV/AIDS-affected children's resilience and self-efficacy plays a crucial role as it sets the stage for every level of development.

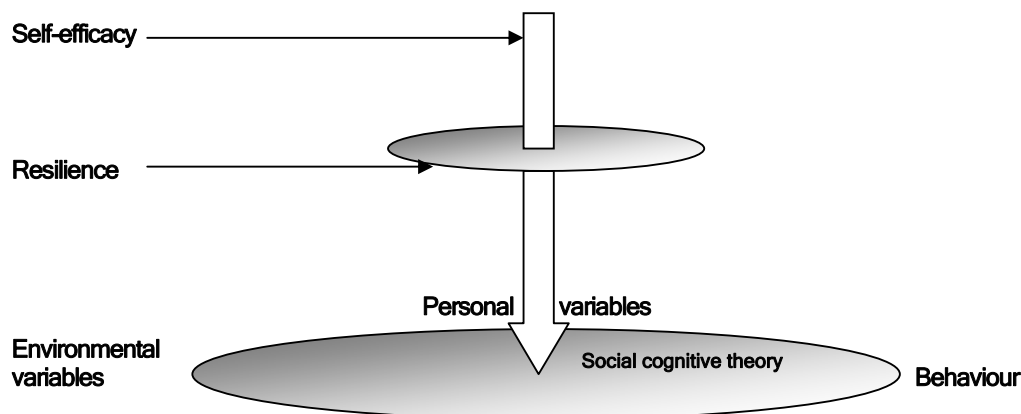

Figure 3.9: Resilience, self-efficacy and reciprocal determinism

Sources: Based on Bandura (1994: 71), Bee (1989: 330), Schunk (2001: 126) and Van Slambrouck (2005: 2 of 4).

The content of both Chapters 2 and 3 that focuses more closely on the interactional processes and key points that signify the relationship between children and their environment from a developmental perspective, are organized and summarised in Figure 3.6. By means of these constructs and processes, children construct their own theories of reality and their experience thereof, to make sense of what they have learned. Guided by Piaget's theory of development, I conclude that children enter each stage of development with basic assumptions and a theory about themselves and the world. Initially, each theory seems adequate, but is eventually given up in the face of new experiences and new information that may facilitate children's ability to adapt to, and cope with, adversities. Succeeding periods of life present new types of competency demands that require further development of personal efficacy for successful functioning.

With each stage of development, resilient and self-efficacious children can thus refine their existing schemes and competencies. Hence, the nature and scope of perceived self-efficacy undergo changes throughout the course of the lifespan. With each successive level of development, the aim is to arrive at a (cognitive) model, theory, or paradigm, or, in Piaget's terms, a scheme, that works for nearly all experiences.

Chapter 4

RESEARCH STRATEGY AND METHODOLOGY

1. INTRODUCTION

This chapter presents an account of the research methodology used for this study. This includes an outline of the strategy, methods, techniques and procedures employed in the process of implementing the research design or research plan pertaining to the empirical part of this study. This section provides a “plan or blue print” (Babbie & Mouton, 2001: 74) of how the research was conducted. The intent of this plan or research design was to structure the research, to show how the major sections of the research project (the samples, measures, and methods) collaborate to address the central research aim (cf. 2., p. 3).

2. RESEARCH DESIGN

The discussion is based on the components of a research design: the information needed, the strategy followed to collect this information, the method and tools used to collect this information, demarcation of place for collection of information and inclusion and selection of participants (i.e. sampling), data processing and analysis and interpretation, consideration of possible harm done with regard to the participants (i.e. ethical considerations), and the report of data (Varkevisser, Pathmanathan & Brownlee, 2003: 94). These components correlate with three focal areas that informed the research design, namely (1) the kind of study planned and the kind of results aimed at, (2) point of departure (i.e. the research problem), (3) and the logic of the research or the kind of evidence that was needed to address the central research aim adequately (Babbie & Mouton, 2001: 76) (cf., 1., 2. and 3., p. 1-6).

2.1 Research methods

Two main research methods are used in dealing with the components of a research design, namely quantitative and qualitative research methods. Each mode of inquiry represents a fundamentally different paradigm (cf. Table 4.1), and the researcher’s actions and choice of method are guided by the underlying features of each paradigm (Hoepfl, 1997: 47).

TABLE 4.1: A comparison of guidelines between quantitative and qualitative research

Quantitative research	Qualitative research
<ul style="list-style-type: none"> • Features are classified and counted, and statistical models are constructed in an attempt to explain what is observed. • Recommended during latter phases of research projects. • Researcher knows clearly in advance what he/she is looking for. • All aspects of the study are carefully designed before data is collected. • Researcher uses tools, such as equipment or questionnaires to collect data. Data collection tools are highly structured and are time-consuming to develop. The main forms of data collection are questionnaire surveys, highly structured observation schedules and analysis of records. • Once the tool is developed, data collection and analysis are relatively fast. • Large samples can be used. • Data is in the form of numbers and statistics. • Quantitative data is more efficient, able to test hypotheses, but may miss contextual detail. • Researcher tends to remain objectively separated from the subject matter. • Theory is largely causal and is deductive. 	<ul style="list-style-type: none"> • The aim of qualitative analysis is a complete, detailed description. Data cannot be statistically analysed. • Recommended during earlier phases of research projects. • Researcher may only know roughly in advance what he/she is looking for. • The design emerges as the study unfolds. • Researcher is the data-gathering instrument. Data collection tools are more loosely structured. The main forms of data collection are individual interviews, focus groups and less structured observation. • Data collection and analysis are time consuming. • Smaller samples are used. • Data is in the form of words, pictures or objects. • Qualitative data is more 'rich', time-consuming, and less able to be generalised. • Researcher tends to become subjectively immersed in the subject matter. • Theory can be causal or noncausal and is often inductive.

Source: Based on Golafshani (2003: 597-604), Neuman, 2006: 13, 157, 219; Hancock (2002b: 7) and Miles & Huberman (1994: 40).

Most research on resilience has adopted the quantitative methods of epidemiological studies, such as broad population surveys, cohort studies and case-control studies (Barton, 2002: 97-9). Surveys attempt to collect information systematically, allowing for the description and explanation of the beliefs, values, and behaviours of people. Although surveys cannot address issues of causality, the advantage and rationale are that they can reveal associations between developmental outcomes and characteristics of individuals and their environments. Another advantage and strength of survey research lies in the fact that it allows for adaptability. Virtually every topic of interest to the social researcher has been approached using the survey method (Williamson, Karp & Dalphin, 1977: 133). Barton (2002: 98) explains that cohort studies begin with two groups that differ in exposure to risk and protective factors. These two groups are followed prospectively to track their subsequent incidence of outcomes. The relative risks of the outcomes for each group are then calculated. Case-control studies, on the other hand, begin by identifying a group that already exhibits a problem or an outcome (the case group). A matching control group that does not exhibit the problem is

identified, and the relative exposure of the two groups to suspected risk or protective factors is then measured.

2.2 Rationale and purpose of a qualitative investigation of psychological resilience among pre-adolescent HIV/AIDS-affected children

The nature of this study necessitated a qualitative approach as the data obtained represents descriptions of the experiences of AIDS orphans. The rationale was that, although the results of qualitative studies in resilience research are found to be consistent with those in quantitative, epidemiological research, detailed descriptions in the words of the respondents, such as opted for in this study, are helpful in highlighting the role of subjective meanings individuals attribute to their contexts and experiences, and are also well suited to the discovery of unnamed protective processes relevant to the lived experience of research participants (Barton, 2002: 101; Ungar, 2003: 85-102). Qualitative studies also elicit and “add power to minority voices [such as those of AIDS orphans] which account for unique localized definitions of positive outcomes, and bring concepts such as risk pileup [cf. risk chains, p. 19], social support, and sense of agency to life” (Barton, 2002: 102).

Although quantitative and qualitative approaches in social research practice interact, qualitative analysis is recommended during the initial phases of research projects (Berg, 2004: 256; Kvale, 1996: 68; Silverman 2000: 9). Therefore, following a qualitative mode of enquiry enabled the researcher to establish a platform for future research in the chosen field. This research approach also supported the main purpose of this study, that is exploration, as a fairly new field of investigation was covered and relatively little information was available (Babbie & Mouton, 2001: 79). Research was also conducted to provide a basic familiarity with the topic. Overall, in terms of the nature of the topic and subjects, the advantages and applicability of a qualitative approach (cf. Table 4.1), this approach was thus considered the most appropriate for this study.

Due to the unique nature of community-based care initiatives and their impact on the resilience of children, a case study design was used to give the researcher an intimate familiarity with these children’s lives and culture, within that specific context. Thus, as such, the strength of case study research, namely that it includes context as an important part of what has to be studied was favourably utilized (Yin, 2003: 1). The use of a case study design also allowed for multi-perspective analyses. This meant that the researcher considered not only the voice and perspective of the children selected for this study, but also that of the relevant key informants, and the interaction between them.

2.3 The research perspective of this study: Grounded and Living theory

Grounded theory is a mode of enquiry that is predominantly located within the domain of qualitative research (Neuman, 2006: 157; Patton, 2002: 127). In grounded theory, simultaneous data collection and analysis is

directed towards generating a new theory about the studied phenomenon (Hancock, 2002a: 6; Neuman, 2006: 157-8). In keeping with this approach, a number of (educational) practitioners also construct their own knowledge and theories by reflecting on their actions, but view research as a continuous process of the fusion of action and theory (Farren, 2005; Hartog, 2004; Sullivan, 2006). In so doing, these practitioners follow a “living theory” approach (Levy, 2003: 2 of 4; Whitehead, 1989: 2-4 of 16) to critically examine their own assumptions and values, thus continually improving their professional practice. As such, living theory embedded in personal experience, based on the integration of known knowledge, newly taught knowledge and increased self-awareness, is context-specific and open to refinement and re-interpretation.

The approach followed in this research was similar to that of living theory in that the researcher followed a systematic process of data gathering and analysis to construct a theory about the psychological resilience of the children selected for this study that not only informed her own practice, but also that of those directly involved in these children’s lives, be it care or education. Viewed as a “living theory,” it allows for future adaptation and “growth” in accordance with change brought about by these children’s development.

2.4 Geographical demarcation and selection of participants

Research focused on HIV and AIDS-affected children from a community care facility, “Lebone Land,” in the Motheo district, Bloemfontein, Free State. Children at Lebone Land come from all the informal settlements surrounding Bloemfontein. Seventy percent of the children at Lebone are affected by HIV/AIDS and the remaining 30% are HIV-infected.

Patton (2002: 244) explains that in qualitative research there are no rules concerning sample size. The researcher considered the following guidelines, suggested by the author to determine the size of the sample: the nature and purpose of the inquiry (cf. 2., p. 3-4; Table 4.1; 2.1, p. 74-5), and what can be done with the available time and resources. A purposive sample (De Vos, Strydom, Fouche & Delpont, 2005: 328-9) of eight children who volunteered to take part in the study was selected from the 70% affected children at the facility. Purposive sampling implies that the participants were chosen by means of an underlying purpose or theme. The researcher targeted a particular group of children, i.e. AIDS-affected children. The strength of purposive sampling lies in selecting information-rich cases for in-depth analysis, related to the central issues being studied. Therefore, the following criteria were applied during the sampling process to adhere to the purpose of the study (cf. 2., p. 3), to reduce variation among participants, and to ensure that the findings of the study represent a meaningful population:

- Children, both male and female, at the inception of adolescence (9-13 years old), and
- those who had lost at least one parent to HIV/AIDS.

The age category of children set out for this study was also significant in that children in this age group are able to solve many types of problems logically if they are focused on the here and now, they start to think in abstract terms, are able to deal with hypothetical situations, think about possible solutions, and use evidence

to make decisions (Papalia & Olds, 1992: 24; Steinberg & Meyer, 1995: 450). Children from 9 to 13 years are also expected to have developed the ability to trust others. Trust is fundamental in promoting resilience, and forms the basis for promoting other resilience factors. Trusting, loving relationships promote acceptance of limits to behaviour and facilitates imitation of role models. Children are then more likely to become likeable, empathetic and caring, optimistic and hopeful, and can more easily engage in successful interpersonal relationships, solve problems in different settings, and reach out for help (Grotberg, 2003: 5-6). Thus, the researcher was able to study these critical aspects concerning children's resilience.

The sample group consisted of both male and female participants. The sampling was aimed at gaining insight about the resilience of this particular group of children, rather than empirical generalization from the sample to a population. Participants selected for this study were considered as separate cases. The rationale for this approach was that cases are "information rich" and illuminative, and may offer useful manifestations of these children's resilience (Patton, 2002: 40). The eight cases were considered the main focus of the research and the particular place of research was merely seen as the backdrop against which the different cases were to be studied. Therefore, as shown in Figure 4.1, the researcher looked for "patterns in the lives, actions and words of people [multiple cases] in the context of the complete case as a whole" (Neuman, 1997: 331).

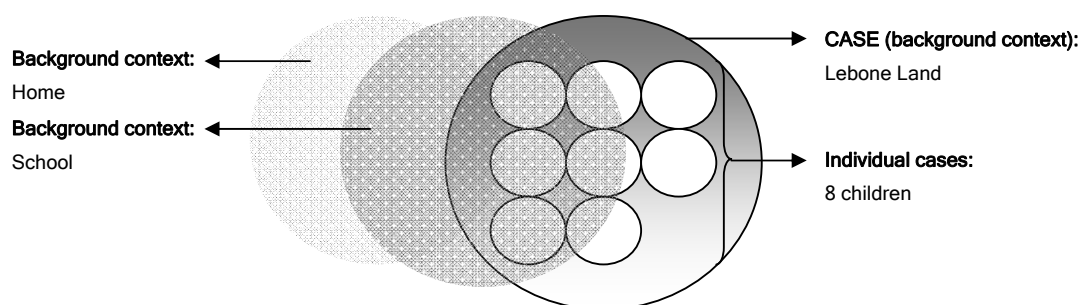

Figure 4.1: Graphical representation of the focus of the study

Source: Based on Neumann (1997: 331) and Ragin (1992: 5).

2.5 Methods of data collection

Semi-structured interviews and related narratives of children were used to gather phenomenological data. In this instance, the term phenomenological refers to data that identifies and describes the subjective experiences of respondents, or in other words, reflects the nature and essence of the lived experience of the

studied phenomenon for the respondent (Hancock, 2002b: 9). These semi-structured interviews consisted of a series of open-ended questions, based on topic areas applicable to this study. In addition, researcher-developed creative tools from the Child-Centred Approaches to HIV/AIDS (CCATH) Project (Healthlink Worldwide & CCATH partners, 2004: 2, 40-42) were used to access and explore the life world of the child and adversities to which each respondent was exposed. These tools, and the Biographical questionnaire used for data collection, as well as the rationale for inclusion of these instruments are detailed further in this section.

2.5.1 Biographical questionnaire

A biographical questionnaire was used to gather information regarding the names, age, sex, date of birth, and grade level at school. Questions regarding the children's place of residence during the school holidays, spoken languages, number of living primary caregivers, cause of parent's death, and the number of siblings and their ages were also included.

2.5.2 Communication mapping

Communication mapping provides insights into the children's lives, who they relate to, supportive networks they rely on, and who they in turn are supporting. This research tool enables the researcher to focus on the quality of individual relationships as well as the quality of environmental supports that are essential to understanding the development of resilience (Reed-Victor, 2003: 3). Therefore, Communication mapping may reveal key aspects of children's resilience, such as open communication with parents or other trusted adults, and the ability to express one's emotions and fears.

First, children are asked to draw a picture of themselves. Drawings of people with whom they live or who are important to them are then added to this picture. Lines are drawn between themselves and the other people in their picture. Up to three lines for each person may be drawn, depending on the importance of that person to the child. The researcher then asks the child about the meaning of the drawing.

2.5.3 River of Life

River of Life is particularly useful in pointing out significant elements that determine children's resilience, such as the extent to which the children have a positive self-image and a realistic, constructive goal for the future. In a large sample of children, these determinants are believed to possibly provide crucial information about children's future engagement in risky behaviour in respect of HIV and other issues. The direction of the line into the future also indicates the extent to which these children feel supported by their environment and the particular initiative's interventions.

Children are asked to draw a river of their life, starting from their birth and projecting five years into the future. An upward arching line depicts the flow of the river during good times in the child's life, and a downward arching line depicts the flow of the river at bad times. Small pictures and/or labels are added to the line drawing, explaining the events that influence the flow of their river.

2.5.4 Happy and sad

Happy and sad provides children, teachers, parents and/or guardians with insights into positive aspects of the children's environment that need to be distinguished and strengthened, and the negative aspects that need to be addressed.

The child draws and labels two pictures: one of what makes a child of their age and gender happy, and another of what makes him/her sad. Such drawings may reveal much about the children's social environment, such as peer group stigmatisation or inclusion of children affected or living with HIV and AIDS, the positive and negative attitudes of teachers and other adults towards children, support in terms of children's basic needs, and children's spirituality.

2.5.5 Rationale for inclusion

The following considerations regarding the participants formed the rationale for the method of data collection, and for the use of the specific research tools:

- The HIV/AIDS status of an individual is often considered a family secret, and disclosure is not permitted by family norms. The reality and effects of living with a family member with HIV/AIDS is often only discussed, for the first time, in the safety of a therapeutic environment. Children need consent to discuss this family secret and seek help coping with altering physical and mental status of family members, changing family roles, and imminent losses (Jackson, 2002: 269-272).
- Lamb & Brown (2006: 220) as well as Freeman, Epston & Lobovits (1997: 145-6) emphasise the importance of making expressive arts such as drawing available as a means of communication to children who may experience verbal shyness, speak another language as their first, are too young to talk, have language-based difficulties, or may primarily be visual or kinesthetic processors. This approach also benefits children who have experienced constriction of verbal expression at certain times, for example due to threats made as a result of abuse, stigmatisation, and the "culture of silence" regarding AIDS, or when there are differences in cultural expression between the researcher and the respondents, for example not making eye contact as a form of respect or polite abbreviated answers. During interviews, drawings may elicit more accurate information of a traumatic event, and facilitate discussion of feelings and thoughts, particularly for children with developmental or learning disabilities (Jolley, Bekhit & Thomas, 2005: 208).

- The research methods used in the CCATH (Child-centred approaches to HIV/AIDS) Project employ drawing as a tool (Healthlink Worldwide & CCATH partners, 2004: 2, 40-42).
- Methods of child-centred participatory research help adult researchers and programmers to find appropriate ways to listen to, communicate with and learn more about children's lives - methodologies that are interesting, enjoyable and non-threatening to children themselves.
- The use of drawings is "likely to reduce the child's anxiety about the situation and the nature of the investigation" (Jolley *et al.*, 2005: 206).
- The reliability and validity of projective tests used as research instruments have not yet been established (Jolley *et al.*, 2005: 207; Lilienfeld, Wood, & Garb, 2005). Thus, the use of drawings for the purpose of facilitating communication in order to gather information about children's experiences and describe routine and problematic moments and meanings in children's lives from a strength-based perspective is proposed, as opposed to the testing, evaluation or assessment of children.
- The positive consequences of using participatory research methods may be that once children become partners in research and evaluation, they gain the confidence and competence to claim active participation in activities at community level.
- Listening and learning from children may also make a profound impact on the attitude of adults to children's competence and ability to act.

Data obtained from seven key informants (i.e. a social worker, two carers, a pastor and three teachers) were collected by means of systematic open-ended interviews to enrich the data gathered during the interviews held with the children. The advantages of using interviews were that this data collection technique is suitable for both literates and illiterates, permits clarification of questions, can be used to probe sensitive or difficult areas, and has a higher response rate than written questionnaires (Varkevisser *et al.*, 2003: 149). This technique also allowed for observation of non-verbal cues and paralinguistics that served to enrich responses given by the participants (Hancock, 2002b: 11).

2.6 Data collection process

Permission was obtained from the administrator of "Lebone Land," Mrs. Avril Snyman, for conducting the study at the facility (cf. Appendices 2 and 3). Informal interviews with staff were arranged to discuss the study, possible considerations regarding the children, time frames, sampling, and participation. A meeting was arranged to introduce both the researcher and the assistant researcher to the children in the sample group, to explain the purpose and nature of the study to them, and to obtain permission from each of the research participants for inclusion in the study. A second meeting was arranged with the educator and social worker from Lebone to gather the biographical information regarding the children selected for this study. Prior to conducting the research involving the children, three employees of the facility were trained to assist with the fieldwork. Their assistance mainly entailed translation and help with any problems that may arise during the research process.

In conducting the research the researcher drew from principles underlying action research, in that the researcher engaged in continuous cycles of planning, acting, observing and reflecting which generally characterise this research approach (Berg, 2004: 195-7; Hancock, 2002b: 9). The systematic transformational process (cf. Figure 4.2) allowed for more fluidity, flexibility and adaptability. Data were transcribed and examined for content immediately following data collection, and ideas emerging from the analysis were included in subsequent data collection sessions.

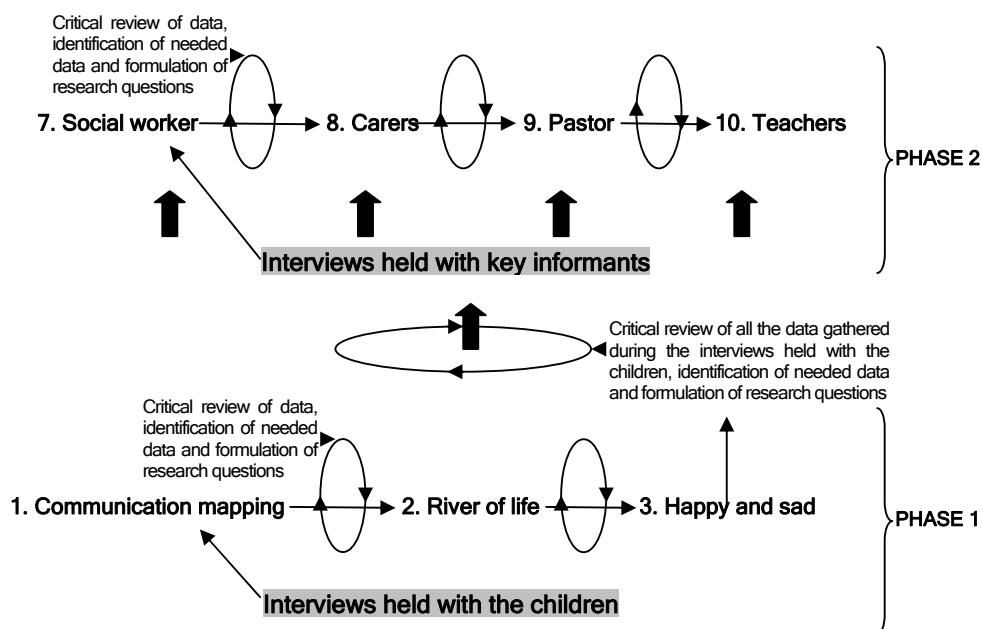

Figure 4.2: The data-gathering process pertaining to each case

This approach enabled the researcher to conceptualise a new theory that was “grounded” in the data, and provided opportunities for increasing the “density” and “saturation” of recurring categories, as well as for following up unexpected findings.

First, interviews were held with the children. Data collection was divided into three stages. Special regard was given to the children in that the whole process was structured in such a way that the children taking part in the study could benefit therapeutically from the process. As the establishment and maintenance of rapport is critical for the disclosure of information, the first stage focused on building rapport with the child (Communication mapping). This entailed showing genuine interest, being accepting of the child and building trust (Gladding, 2000: 129). The second stage was aimed at exploring the child’s life history and adversities to which the child was exposed (River of life). The final stage was directed towards facilitating closure of the whole process (Happy and sad). Activities were structured in such a way that the children could draw without being interrupted as they found it difficult to answer questions and draw simultaneously. When necessary,

research tools were adapted to facilitate data gathering, and sessions were extended to ensure that children were emotionally stable after the disclosure of disruptive feelings and experiences. After every consecutive stage the data obtained was reviewed, areas that called for (further) investigation were identified, and if necessary, additional research questions were formulated and research schedules adapted accordingly. Information obtained during these sessions provided the researcher with a database “from which to work and add to.” The data obtained was reviewed and interview schedules for each of the key informants were compiled. The interviews with the social worker, carers and pastor were held at Lebone, and the teachers were interviewed at the school. Again, permission was obtained from the principal of Shanon Intermediate School to conduct the research at the school. Consent was also obtained from the teachers and each of the other key informants for taking part in the study (cf. Appedices 2, 3, 4 and 5).

2.7 Objectivity, validity and reliability

Qualitative researchers employ various strategies or measures to achieve objectivity with the purpose of providing an accurate account of the object and phenomena being studied. In conducting this study, the researcher “let the object speak for itself” and applied so-called subjectivity to understand and interpret the data within a specific context in order to increase objectivity (Niemann, Niemann, Brazelle, Van Staden, Heyns & De Wet, 2000: 285). The application of subjectivity implies that the researcher imagined or placed herself in the position of the respondent to understand, anticipate, and interpret his/her experience or behaviour. Qualitative researchers refer to this spiritual activity as “role taking” (Lofland, 1971: 4; Niemann, 1994: 160; Smaling, 1994: 54). Thus, the aim and rationale for applying these principles were objective documentation of the world from the point of view of the respondents selected for this study. Therefore, objectivity in qualitative research does not exclude subjectivity, making the researcher a passive recipient or “robot,” but instead presupposes that the researcher objectively understands, recognises and respects the respondent’s experiences as his/her own psychological reality or “erlebnis” (Ratner, 2002: 3 of 7; Swanepoel, 2000: 91). This view suggests an active integration of objectivity, and what may be referred to as independent subjectivity. In the case of this study, objectivity also rested on clear articulation of procedures, areas of investigation and research tools and methods used to gather data to allow for replication of the research, analysis review and verification of the findings (Berg, 2004: 258). The use of audio recordings also contributed towards improved accuracy and objectivity of the data collected.

The validity of the research is determined by the extent to which the findings are also tested and refined by other research, and whether the findings reflect the intent of the research (Goetz & LeCompte, 1984: 221). Reliability is indicated by how consistent the results are, and thus achieved by elimination or limitation of random errors that can influence the results (Goetz & LeCompte, 1984: 211; Graziano & Raulin, 1989: 394; Smaling, 1994: 78). The following measures were used in this study to address issues concerning validity and reliability (Babbie & Mouton, 2001: 122, 396-7; Hyatt, 1986: 35-7; Niemann *et.al.* 2000: 284-285; Steyn, 2001: 70):

- A cumulative view of data drawn from various sources enabled the researcher to verify the research findings where data intersected. Contradictory findings were discussed and often referred back to the respondents. For instance, during or following an interview held with a child, the researcher's observations were discussed with the assistant researcher and then often verified with the child. Parts of the data obtained during the interviews conducted with the children were verified during the interviews conducted with the key informants.
- Competent individuals are selected to assist with the research and observations.
- Research tools that have proven their reliability in previous research were used - such as those listed previously.
- Logical reasoning and interpretation, based on the findings of the literature review, was applied in terms of sampling and what the researcher planned to study. Therefore, by means of systematic data analysis and selection of participants considered able to supply the information, a balance between "letting the object speak for itself" and using abstracted categories for analysis and interpretation was created.
- Data are presented in terms of categories and interpretations, supported by direct quotations.
- Limitations regarding the research design, research process and data collected were communicated.
- A detailed account and description of the research process, measures used, procedures followed and research situation and context were provided so that the study may be replicated.
- The rationale for the researcher's choice of methods is clearly stated.

2.8 Data presentation and analysis

In presenting the data the researcher considered each case unique. Therefore, all the data relating to a case were grouped, as opposed to grouping and presenting the data according to the specific informants (cf. Chapter 5). This was done in order to ultimately provide the researcher with a holistic picture of the group of children, as well as every separate case. By means of rich, detailed, concrete description - "thick description"- the researcher intended to familiarise the reader with the life-world of the respondents so that the reader may derive his/her own understanding of the phenomenon studied, and draw his/her own interpretations about meanings and significance (Patton, 2002: 438). Data analysis entailed analysis of codes, themes, and patterns in the data by means of the constant comparative method to transform data into findings. This method is applicable as it is directed towards finding patterns and commonalities within human experience, and developing ways of understanding human phenomena within the context in which they are experienced (Patton, 2002: 62-3). The constant comparative method is also appropriate for creating knowledge that is more generally descriptive or interpretive, such as coping with the effects of HIV/AIDS or the experiences and psychological resilience of HIV/AIDS-affected children. Additionally, this method is conducive to the employment of simple counting procedures, known as "descriptive counting" (Morgan, 1997: 61). In the case of this research, the use of these procedures adds more meaning and "value" to the information obtained, "otherwise lost in intensive, qualitative analysis" (Steyn, 2001: 62), and supports the study's conclusions and recommendations (Denzin, cited in Brannen, 1992: 13; Morgan, 1997: 61; Silverman, 1985: 17, 140), bearing in mind intervention and prevention programmes. Thus, this method of

data analysis allows the researcher to follow a quantitative approach to qualitative analysis. It is admitted that the identification of, for example, shared or common experiences, such as the death of a parent, or shared clusters of resilience strengths may serve as indicators or guidelines as to which issues or “areas” should be targeted by intervention and prevention programmes, considering this particular group of children. In essence, though, this study remains a qualitative study.

The following four distinct stages, proposed by Lincoln & Guba (1985: 339), were applied in using the constant comparison method:

- comparing incidents applicable to each category,
- integrating categories and their properties,
- delimiting the theory, and
- writing the theory.

This analytical strategy involved the following steps: First, an inductive analysis or “open coding” (Wilson Scott, 2004: 114) of the qualitative data (interview transcripts, field notes and documents) was done to identify critical themes and subcategories that emerged from the data and to create descriptive, multi-dimensional categories which formed a preliminary framework for analysis. This first level of analysis was aimed at being true to, respecting, and capturing the details of the individual cases being studied (cf. Chapter 5). Secondly, comparative, cross-analysis followed from, and was determined by the “quality” of the individual case studies (cf. Chapter 6). As necessary, categories were added, changed or replaced at later stages. Thirdly, identified categories were re-examined to determine how they are linked (i.e. axial coding) (Kelle, 2005: 5-6 of 17; Neuman, 2006: 462; Wilson Scott, 2004: 114) and how they could be combined in new ways to build a conceptual model for determining whether data is adequate to support that interpretation. The final step (cf. Chapter 7) entailed creative synthesis and further interpretation of the data analysed (De Vos *et al.*, 2005: 340; Patton, 2002: 41). The entire process or analytical strategy underpinned the characteristics of this qualitative inquiry, as it was particularly orientated toward exploration, discovery and inductive logic (Patton, 2002: 55).

2.9 Ethical considerations

Ethical practice is crucial when working with children and adolescents, because of the difference in power between the participant and the investigator, particularly in the case of younger people in vulnerable situations (Neuman, 2006: 131; Schenk & Williamson, 2005: v, 3). Measures adapted from the ethical considerations discussed by Neuman (2006: 132-142) and those listed by Patton (2002: 408-9) and Varkevisser *et al.* (2003: 153) were taken during the research procedures to ensure that the respondents did not suffer physical or emotional harm: a sample from the research population was drawn, consent for gaining access to records containing personal data was obtained, informed consent was obtained prior to the study or interviews, and a good relationship with the children was established. Confidentiality of the children’s identity and the data obtained was also ensured, enough was learnt about the culture of informants by

means of informal interviews with doctors, teachers, nurses and caregivers at various health, day-care and educational facilities to ensure that it was respected during the data collection process, and the presence and involvement of other qualified persons (i.e. a teacher, psychologist and other caregivers) was arranged at various stages of the data collection process, in particular when dealing with sensitive issues, as accountability and transparency were central to the achievement of ethical practice.

In anticipation of direct and indirect consequences of the information-gathering process and to protect the children from developing attachments to outsiders following the activity, the researcher selected responsible fieldworkers who would remain in the research area after the research activities had concluded. These fieldworkers were also given the opportunity to learn from the research activities which empowered them to assume a supportive role with regard to the children, if necessary.

3. SUMMARY

In conducting the empirical investigation the researcher followed a qualitative, case study approach to explore the concept of psychological resilience among a purposive sample of eight AIDS orphans. Data were collected by means of semi-structured interviews. The data collection process comprised two phases: interviews held with the children selected for the study, and interviews held with key informants. During the first phase, three researcher-developed tools (i.e. Communication mapping, River of life and Happy and sad) were used to facilitate the data-gathering process. Data gathered during the second phase mainly served to enrich the data collected during the first phase. The following chapter presents the data collected.

Chapter 5

RESULTS OF THE EMPIRICAL INVESTIGATION

1. INTRODUCTION

This chapter presents the results of the empirical investigation into five sections. The first briefly describes and gives an historical overview of the research setting, Lebone Land. Information was gathered during interviews with the educator and liaison officer at Lebone, and obtained from informative posters on the boardroom's notice board. This section also aims to contextualise the results. Section two reports on the data obtained in the individual cases, whereas section three presents additional or complementary data collected during the interviews held with the various key informants. The aim of sections two and three is to describe the process and procedure followed during this investigation. The final section gives a summary of this chapter.

2. THE RESEARCH CONTEXT - LEBONE LAND

Lebone Land, formerly "Lebone House", a day-care facility for HIV/AIDS-infected and -affected children, was established in May 2000. Within a few months, Lebone House was registered as a 24-hour care facility. With increasing numbers of HIV/AIDS-affected and -infected children, the need for additional care and housing intensified and thus, in July 2002, the international company Maersk Sealand funded the institution of "Lebone Land".

Lebone Land is located on a 17-hectare plot in Bloemspruit, in close proximity to the neighbouring black township. The facility is surrounded by other plots and houses. The buildings on the grounds have been renovated and are presently used for administrative and schooling purposes. The two renovated houses on



the property are used to accommodate employees and children. “Maersk house” accommodates pre-schoolers while the older children stay in Rist House. The Lebone Education Centre was established in September 2002 as part of Lebone Land. It comprises four sections: (1) a crèche for infants aged up to twelve months old, (2) two classes for toddlers, one class for children between the ages of one and two, and the other for children between the ages of two and four, (3) a grade R class for children



between the ages of five and six, (4) and afternoon classes for children in Grades 1 to 5. The Education Centre is also open to day scholars living in the community surrounding Lebone Land. Because of the extreme poverty of the community, school fees are not charged.

The school has six employees. There are nine house staff, approximately 14 employed staff at the Lebone Agriculture/Skills Centre, and 192 full-time and part-time volunteers from all walks of life. Many volunteers work at Lebone Land as part of Lebone’s income-generating, poverty alleviation and skills development programme. The volunteers are involved in cultivating the land, gardening, building, making nappies and beds for the children, handcrafts, washing clothes and child care. Since the opening of Lebone Land, a study room, a small library and a computer centre have been made available to the children by means of donations and funding.

3. DESCRIPTION OF CASES

This section reports on the information gathered during the interviews held with eight orphaned children and key informants, in particular, the social worker, carers, and pastor from Lebone, and educators employed at Shanon Intermediate School. This information is grouped according to the respective cases in order to provide a holistic picture or portrait of each child selected for this study. Each case is documented by a presentation of (1) biographical data; (2) idiographic data gathered (with the help of three research tools: Communication mapping, River of life as well as Happy and sad) during semi-structured interviews held with the children, and (3) information gathered during semi-structured interviews held with the key informants. These interviews took place at Lebone and Shanon Intermediate School between 4 July and 18 September 2006. The interviews held with the social worker focus on obtaining information on each child’s family history and structure, the nature of disruption in the children’s lives and a short description of her view of each child. The information gathered during interviews held with the carers focuses on the behaviour and general observations of each child. Information obtained from the pastor is determined by his views of the children, their characters and/or possible changes perceived since they were accommodated at Lebone. Information gathered from the teachers focuses on the children’s academic performance and behaviour at school.

All the information was obtained from the records and sources available at the time. A narrative account of the information provides a full description of how and what information was conveyed by the children. Direct

quotations used in the text represent the words of the children as related by the translator. Pseudonyms are used to protect the children's identity. For purposes of clarification, the names of the individuals and their job descriptions referred to by the children during the interviews are listed below.

Mistress/Monono/Gloria:	Monono Gloria Pitso Educator and Lebone Education Centre manager
Pappa George:	George Pule Matsoakeletse Lebone Land pastor
Pappa Snyman/Willem:	Willem Snyman Project manager and skills development/training coordinator
Mamma Snyman/Avril:	Avril Snyman Trust administrator
Mamma Lulu:	Lulu Ngcobo Manager and social worker at Lebone (not qualified as such)
Mamma Andri:	Andri Holder Personal assistant to the trust administrator
Mamma Teboho/Emelia:	Mponyana, Emelia Molefi Caregiver at Lebone
Rakgadi:	Nancy Kemme House manager, cook and caregiver

The drawings of the children added to the text are not presented for the sake of analysis, but to illustrate the process followed during the interviews. The names of the children and significant others depicted in the drawings are concealed in order to protect their identity.

Finally, the key themes and associated subcategories identified from the information concerning a case or subject are arranged according to an analytical framework. This framework comprises four main categories, namely (1) external realities, (2) external supports, (3) inner strengths, and (4) interpersonal, problem-solving skills. Based on the findings of the non-empirical investigation, these four categories constitute the four main components that contribute to the establishment, sustainment and development of psychological resilience (also cf. Table 2.4).

SUBJECT 1 - Dikeledi

1. Biographical information

Dikeledi, an 8-year old girl, is the youngest of all the children in the research group. She turned 9 approximately two months after the interviews. If the researcher had waited two months before conducting the interviews, this would not necessarily have affected the given information. The researcher kept contact with the respondent until her birthday, after which the interviews with the key informants were conducted. This allowed for verification and validation of the previously gathered information.

Dikeledi was born on 8 September 1997, has no siblings, and lost both her parents. Her mother died of AIDS, and the cause of her father's death is unknown. The date of her parents' death is also unknown. She was admitted to Lebone on 29 August 2003 as her mother had fallen ill. Although Dikeledi is Sesotho speaking, she speaks English as a second language, and is in Grade 3. She spends her holidays at Lebone as there are no other known relatives to visit her or people to collect her during that time.

2. Idiographic data

2.1 Communication mapping

During this first session Dikeledi was asked to draw a picture of herself and of the important people in her life. She was given liberty to use any of the available pens and crayons, and the researcher assured her that there were no set rules to follow. Her demeanour was friendly, shy, but co-operative, and she seemed to be absorbed in the activity.

When she had finished the drawing of herself, she was asked to tell the researcher about the picture. She pointed out that the figure in the drawing is her portrait, and that the other symbols represent the sun and a table at which she eats. She portrayed herself as a happy little girl who would be sad if she were involved in a fight or if she saw someone fighting. She related that, previously, she had been saddened by the sight of her "brother" fighting with someone in the street. Although she enjoys playing with friends, especially when she is sad, she doesn't like it when they fight. She reacts by no longer playing. If others want to fight with her, she only fights back, if necessary, in defence, walks away if she doesn't win, and finds another friend to play with. She mentioned that she is scared of robbers, also referred to as thugs, and reported that she had only seen them passing in the street.

Dikeledi was then asked to draw the faces of those whom she regards important, and mean a lot to her in her life. She carefully drew the faces of her mother, her father, a sibling, two brothers, a sister, granny,

grandfather and a friend. With the exception of her friend, these persons, according to information available at the time, had either passed away or never existed. Dikeledi said that she keeps contact with her friend, and that, although she knew that her mother had passed away, she is the person closest to her. Of all the people she drew, she misses her mother the most, trusts her father the most, loves her sister very much, and the sibling makes her happy. She would turn to her father when she was hurt.

Dikeledi told the researcher that the best thing that ever happened to her was a birthday party held for her at Lebone. Her brother wears the watch she was given as a present. When asked about her future, she said that she would “*go along with friends.*” Throughout the session she kept turning her feet and playing with the pen when she was questioned.

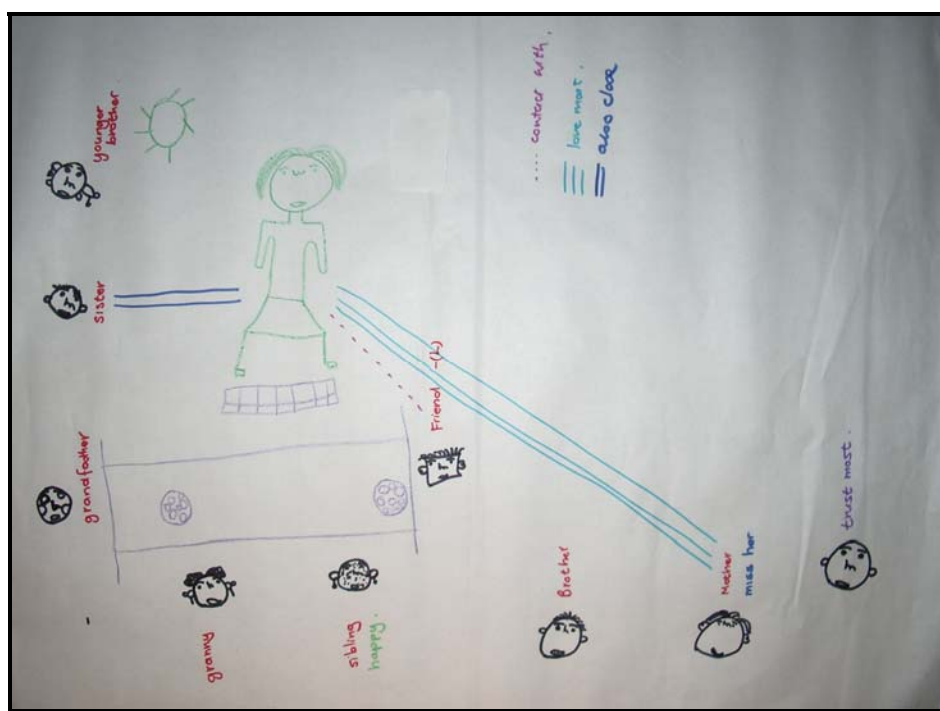

Figure 5.1: Dikeledi. *Communication mapping* (2006). Pen on paper, 58 x 81cm

2.2 River of life

For this session Dikeledi was asked to draw “a river of her life.” The researcher explained that during sad, unpleasant or difficult times the river is depicted as flowing down, and as flowing up during good or happy times in her life. She apparently did not comprehend the assigned task. With every consecutive age given, she repeatedly drew her river flowing up and then down again, seemingly not giving much thought to what had specifically occurred at the time. The researcher then asked her to draw a line, without considering age,

going up and down as she thought of good and bad things that had happened in her life. She related that when her river flows up, it is because God made her heart feel good. “*Jiving*” to music at Christmas and New Year parties, playing and eating with friends as well as learning at school also make her river flow up. Swearing and fighting make her river flow down. She mentioned that she had seen people fighting in the street. She said “*I become sad in my heart,*” and added that then she usually reports the fight to someone. Dikeledi remembered when she saw her mother and father fighting. At the time she cried and then left to tell other mothers about the fight. Dikeledi failed Grade two at school, and this also made her river flow down. She cried when that happened and had then learnt harder. She believes that she is good at building puzzles. She aims to learn hard with the help of the educator from the pre-school at Lebone to become a good doctor, because she wants to heal people.

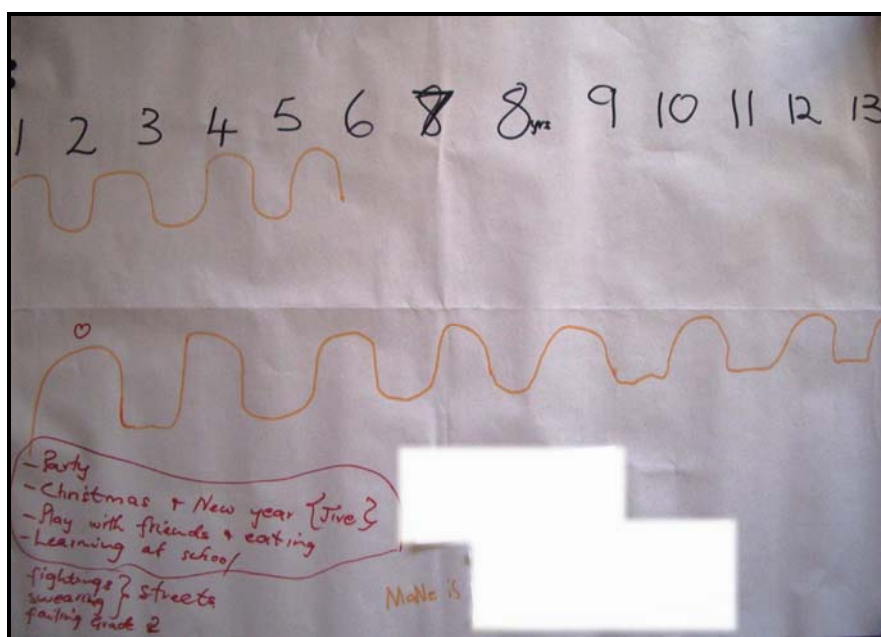

Figure 5.2: Dikeledi. *River of life* (2006). Pen on paper, 58 x 81cm

2.3 Happy and sad

During this session Dikeledi was asked to draw two pictures. First, she was asked to depict the saddest thing that happened in her life. She thought hard about what had made her sad, and appeared saddened by the thought. At first she said that she can think of nothing. The researcher then asked her whether there had been anything that had made her cry in the past. She recalled the day in April when they went to the graveyard to bury a child from Lebone. Although it was not a close friend, she loved him very much. The researcher asked her if she could remember when someone close to her died. Dikeledi mentioned the name of another child from Lebone who had passed away. Thereafter she spoke of events linked to the death of

her mother, and drew a picture of their house as she had found it after her mother's death. Dikeledi occasionally visited her ill mother at home, but had not seen her the day she passed away. She recalled how sad and scared she was when she entered the house one day to find that her mother was not there. Being home alone, she had become afraid because she thought that "*tsotsis might come and hurt her*". She went to another house to ask where her mother was. They told her that she had passed away. She cried when she heard the news, went home, and slept there alone. When she woke up, she said she ate the food which her granny had made for her. During this session it became evident that the granny she referred to in the first and in this session is a neighbour and not her biological grandmother. This woman always bought Dikeledi sweets, occasionally gave her some money, and looked after her mother when she was ill. Dikeledi misses her very much. She mentioned that her sister, referred to in the first session, means a lot to her too.

The second task was to draw a happy picture. She depicted herself at a birthday party with two friends from home. She mentioned that the party was held for her at home by her "*granny*." She also spoke of her mother, and drew a picture of her as she remembers her. Her fondest memories are of her mother giving them things to "*play fantasy, make belief*" with, and sending her to the shops.

Dikeledi said that listening and singing in church makes her proud. She thought that she could be stolen by "*tsotsis*" if ever she found herself in a difficult situation again, and said that she would scream and "*shout to anybody or people next door*" if that were to happen. She was more responsive during this last session, and when the researcher held her, she seemed very shy, but calm.

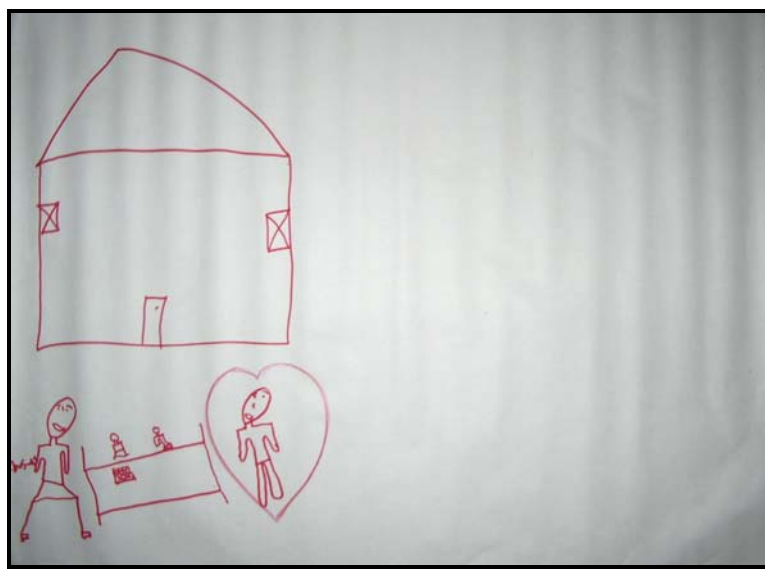

Figure 5.3: Dikeledi. *Happy and sad* (2006). Pen on paper, 58 x 81cm

3. Interviews held with key informants

The next sections present the results of the interviews held with key informants, in particular the social worker, two of the carers and the pastor at Lebone, as well as a teacher at Shanon Intermediate School. These results concern Subject 1.

3.1 Social worker

Dikledi's father passed away shortly after she had been accommodated at Lebone. Her mother had befriended another man after her husband's death. Dikeledi referred to him as her own father. Both her mother and the boyfriend were unemployed. The boyfriend had children of his own, and they were the brother and sister to whom Dikeledi had previously referred. Although the boyfriend was still alive, he had no interest in Dikeledi. The social worker was not prepared to let him take care of Dikeledi, because he was an alcoholic. Despite this, Dikeledi had had a good relationship with him. Dikeledi's mother was also an alcoholic, and because she had also had relations with other men and had been away from home at times, unable to take care of Dikeledi, she had given consent for her daughter to be taken to Lebone. She had always been willing to attend the parents' meeting at Lebone, and discuss problems with the social worker. The social worker described the mother's relationship with Dikeledi as: "*The mother was loving her a lot, too much, she was always buying her some new clothes if she was going to visit her.*"

The social worker explained that on one occasion Dikeledi's mother had phoned to ask if they could bring Dikeledi home for the Christmas holidays. Dikeledi was sent home, but a week after the school had reopened, she had not been returned to Lebone. By the second week, the social worker decided to visit Dikeledi's home to enquire about her absence. She found that Dikeledi had been staying with another woman. Dikeledi's mother previously told the social worker that that woman was related to them. During the interviews with Dikeledi, she had referred to her as a neighbour and grandmother, which she was not. The woman with whom Dikeledi stayed told the social worker that Dikeledi's mother had passed away that same day and that this was the reason why she had not taken her back to Lebone. She said that by the 24th of December, Dikeledi's mother had been very ill. "*She was lying on the bed without talking or eating and she was just opening her eyes.*" A home-based carer had discovered her in that state, and had arranged for her to go to Naledi hospice where she passed away. The day her mother was taken away, Dikeledi was playing elsewhere, and was not aware that her mother had been removed from home. They did not wait to inform her because her mother had been extremely ill, and they had wanted to avoid the possibility of Dikeledi having to witness her death. When Dikeledi returned home, she found the house empty. The social worker could not say where the boyfriend and his children were at the time, but believed that it was unusual for a child to be left to sleep alone in the house, especially if neighbours were aware of the situation. According to the social worker, a home-based carer had taken Dikeledi to the woman because Dikeledi's mother had also told her that the woman is Dikeledi's grandmother. This woman with whom Dikeledi stayed told her that her mother had died, but Dikeledi's mother actually only died in January the following year. The social worker

found Dikeledi crying a lot. She then arranged for Dikeledi to return to Lebone, and asked the woman to inform her telephonically of the funeral arrangements.

A month after the funeral, another woman who lived in a nearby township and who claimed to be Dikeledi's mother's sister contacted the social worker. This conversation revealed that, although Dikeledi had been sent home for her mother's funeral, Dikeledi and the woman with whom she stayed did not attend the funeral, the reason being that the woman was only an acquaintance of Dikeledi's mother. The aunt arranged to meet with the social worker the following week, but phoned the previous day to cancel the appointment. She said that she did not have enough money for transport and that she would contact the social worker as soon as she had made some arrangements. She has not phoned since. The social worker never heard of the "grandmother". The social worker tried to get a court order for Dikeledi to stay at Lebone permanently.

At first, Dikeledi wet her bed every night at Lebone, but since her mother had passed away it was "*on and off*." She described her as a quiet girl who was not afraid to ask people at Lebone for help if she needed something, was unhappy or felt sick.

3.2 Caregivers

The carer described Dikeledi as a good child. She always listens, and when she makes a mistake, she always feels very bad and apologises to the carer. She has two close friends, one of whom is Lebo. She enjoys playing with them, and never fights with others. When some of the older children, for instance Khaya and Zandi fight, Dikeledi is upset. She cried once, and told the carer that she did not like it when they fought. Dikeledi wets her bed every night, and the carer said that she often looks sad when that happens. On one occasion, some of the other children told the carer that Dikeledi had taken her wet blankets and put them in the bathroom and hid her soaked underwear in a cupboard, in-between the children's clean clothes. The carer then spoke to her alone, and told her to tell her if that happened. Dikeledi cried and was very apologetic throughout the day.

A few days before the interview, she told the carer that she wants to go home like some of the other children. She knew that her mother would not be there. The carer said that this had made her sad and that she misses her mother very much. Dikeledi believes that the shoes and skirts her mother bought for her are still at home, and that she wants to go home to collect them. The carer told her not to worry, that she is there for her and cares about her. She suspects that Dikeledi also misses having her own clothes as all the children share clothes at Lebone.

She is very naughty in the sense that she would come running to the carer and state in an urgent and playful tone that the other children had hit her, that she is angry and that she only wants to play with her and not with the other children. The carer likes her a lot because "*she's free*."

The other carer also described Dikeledi as a naughty girl: *“she’s naughty like a boy.”* The carer noticed that she would gossip about the other children. For instance, she overheard her saying something nasty about another child’s underwear. Although she is naughty, she is good in the sense that she loves the smaller children in the house and helps to feed them. Dikeledi often helps to sweep the house, too. The carer added that Dikeledi is a clever girl, who does well at school. She admires the way Dikeledi dances. She said that she is so *“loose.”* The carer said that Dikeledi does not have specific friends. She enjoys playing with all the children. She is a lively child who runs around and plays the whole day. Dikeledi loves playing soccer and cars with the boys, and often disciplines the other children if they are naughty. The carer noticed Dikeledi’s embarrassment when the other children commented on the fact that she had wet her bed. She overheard Dikeledi telling the other children that when she is older, she will take the carer outside and make her walk barefoot over the small bushes because she had been so strict with her the other day.

3.3 Pastor

According to the pastor, Dikeledi was raised in totally unacceptable circumstances. She lived in a small house with her alcoholic mother and her mother’s boyfriend. There was no income, food or care. The pastor said that he had been there the day Dikeledi was fetched from home to be accommodated at Lebone. He recalled that day: *“I said to my heart, that this lady, this child, is very strong. Living in a situation like this, she’s very strong. I wasn’t a child of that family, but I could feel trembling, but in her you could see she had accepted her situation”*. Dikeledi was very quiet and it seemed to him that she had wondered how she was to rely on them. Since that day Dikeledi has changed considerably. She has become more talkative and *“free”*.

3.4 Teacher

The teacher described Dikeledi as *“all right, she likes to play, but sometimes I have a problem with her because it feels that she’s neglected, because sometimes she’s too dirty.”* The teacher perceived her as being untidy and recommended that the people at Lebone *“clean her up”* and cut her hair *“because as a child they play”*. The teacher also assumed that Dikeledi had not washed herself properly.

According to the teacher, she is coping in class, and no other problems have been reported. He reasoned that she has no other problems in class because *“she doesn’t understand the situation, because eh, I think at Lebone they make her feel at home, she doesn’t miss her parents as such”*. The teacher said that Dikeledi does well in her schoolwork, but like any other “normal” child, she is a little naughty or rather mischievous at times. She often hides other children’s books or takes their pencils. He said: *“She’s just playful, but if I talk with her, I’m a little bit angry at her, she does her work, she’s o.k., no problem”*. The teacher also thought that putting pressure on Dikeledi would help to motivate her to do her work. He perceived her as a fairly intelligent girl. Although she does not have a best friend at school, she has many friends in all age groups, and she plays with children who are not from Lebone.

4. Identified themes and categories

Table 5.1 presents the identified themes and associated subcategories from the information concerning Subject 1. Table 5.2 organises the subject's responses to the external realities listed in Table 5.1 according to the child's initial (i.e. at the time of the adversity) and present (i.e. at the time of the interview) thoughts, behaviours and feelings or emotions. Chapter 6 analyses in detail and discusses these responses.

TABLE 5.1: Identified categories and subcategories (Subject 1)				
	External realities (stressors)	External supports	Inner strengths	Interpersonal, problem solving skills
Communication mapping, River of life, Happy and sad.	Serious illness of family member Loss of primary caregiver Death and funerals Loss of friends Crime Violence School failure (learning problems) Anti-social values of family members Relocation	Supportive relationships <ul style="list-style-type: none"> Imaginary family Neighbour at home Close friend Other friends God Educator at Lebone Supportive environments <ul style="list-style-type: none"> Church School 	Faith <ul style="list-style-type: none"> Healing Morality and social values <ul style="list-style-type: none"> Against violent behaviour (i.e. swearing and fighting) Integrity <ul style="list-style-type: none"> Acts on convictions and stands up for her beliefs Emotional management <ul style="list-style-type: none"> Able to recognise feelings and control undesirable feelings Creativity and Imagination <ul style="list-style-type: none"> Playing fantasy, "make-belief" Imaginary family Achievement motivation <ul style="list-style-type: none"> Motivated to do well in school Optimism and positive identity <ul style="list-style-type: none"> Positive view of personal future Happy disposition Trust <ul style="list-style-type: none"> Father (Imaginary) 	Problem solving ability <ul style="list-style-type: none"> Able to find or ask for help Learns harder when failed Perseverance <ul style="list-style-type: none"> Learns harder when failed Self-efficacy and personal power <ul style="list-style-type: none"> Belief in ability to exercise control over future and threatening situations Goal setting, purpose in life and commitment to learning <ul style="list-style-type: none"> Related to helping others Caring Constructive use of time <ul style="list-style-type: none"> Playing
Additional identified subcategories				
Social worker	Family dysfunction <ul style="list-style-type: none"> Alcohol abuse Neglect <ul style="list-style-type: none"> Mother Separation from parent Unemployment	Supportive relationships <ul style="list-style-type: none"> Mother's boyfriend Children of mother boyfriend Mother Home based carer Elderly woman (i.e. an acquaintance of Dikelidi's mother) Supportive environments <ul style="list-style-type: none"> Lebone 	Initiative	Communication <ul style="list-style-type: none"> Disciplines others that do wrong
Carers	Supportive relationships <ul style="list-style-type: none"> Boys 	Obedience Morality and social values <ul style="list-style-type: none"> Love 		Communication <ul style="list-style-type: none"> Apologises when she has done something wrong
Pastor	Poverty			Acceptance
Teachers		Supportive relationships <ul style="list-style-type: none"> Many friends, of all age groups, at school 	Intelligence	

TABLE 5.2: Responses to stressors or adversities (Subject 1)		
External realities (stressors)	Initial thoughts, behaviour, feelings or emotions	Present thoughts, behaviour, feelings or emotions
<p>Separation from parent, death and the loss of primary caregivers</p> <p>Relocation</p>	<p>Dikeledi felt sad and scared when she entered the house and her mother was not there. She considered her mother's boyfriend as her father. Dikeledi cried a lot when the social worker found her. Dikeledi wet her bed every night at Lebone and looked sad when that happened. On one occasion, she hid her soaked underwear and blankets in a cupboard, and when the carer asked her about what she had done, she cried and was very apologetic throughout the day. Comments by the other children made her feel very embarrassed.</p>	<p>Dikeledi misses her mother and has fond memories of her. She longs to go home like some of the other children and the thought of her mother not being there made her feel sad. She also misses wearing her own clothes - the clothes her mother bought her. Since her mother's death, Dikeledi only wet her bed every so often. According to the teacher, she did not wash herself properly and needed attention and care in that respect.</p>
Loss of friends	Dikeledi cried at the burial of her friends.	She thinks about how much she had loved her friend .
Crime	Being home alone made Dikeledi feel scared . She left the house to enquire about her mother's whereabouts .	Dikeledi is afraid of "tsotsis." If ever she found herself in a difficult situation and were confronted by "tsotsis" she would scream and shout for help .
<p>Violence</p> <ul style="list-style-type: none"> Fighting <p>Anti social values of family members</p> <ul style="list-style-type: none"> Brothers and parents fighting 	<p>Dikeledi felt sad when she saw people fighting in the street and cried when she saw her mother and father fighting. She usually reported fights to others. The carer noticed on one occasion that Dikeledi became very upset when some of the other children had fought. Dikeledi then explained her views on the matter to the carer. When her friends fought with her she stopped playing, fought back and walked away if she did not win.</p>	It makes her sad to be involved in a fight.
School (failure)	She cried and learnt harder .	Dikeledi is mischievous or naughty at times. She would hide other children's books and pencils . She listens and does her work when she is disciplined.
<p>Family dysfunction</p> <ul style="list-style-type: none"> Alcohol abuse <p>Unemployment</p> <p>Neglect</p> <ul style="list-style-type: none"> Mother <p>Serious illness of her mother</p>	Dikeledi accepts her situation . She loved her mother and had a good relationship with her mother's boyfriend .	

Risk factors and stressors pertaining to Dikeledi's family and home environment include family dysfunction, due to alcohol abuse by her caregivers, a lack of care, violence, conflict, unemployment of caregivers, and resulting poverty. In addition, neglect, attributed to her mother's promiscuous behaviour, separation from her mother, illness, death, and absence of her biological father and eventually of her biological mother. Adversities pertaining to Dikeledi's school environment include interrupted school attendance and her failing Grade two. At Lebone, she was exposed to the death and funerals of two children for whom she cared a great deal. Dikeledi is well aware of criminal activity in her community. During the interviews she twice referred to "tsotsis," and once to robbers and thugs in the street which she experienced as stressors. Despite these realities and feelings of sadness, fear and longing, Dikeledi exhibits inner strengths and strong interpersonal and problem-solving skills which enable her to react in a resilient way.

With regard to her home or family environment, Dikeledi displays the ability to accept circumstances which she cannot change. She is very close to her “family” in that she has fond, loving memories of her mother; she trusted her mother’s boyfriend to whom she would turn if hurt. She had found joy in, loved, and accepted his children as her own brothers and sisters.

Dikeledi uses initiative and open communication to discipline others, thus conveying her needs to adults; she acts with integrity, and copes with stressors such as bedwetting, the loss and absence of her mother, and abandonment. She displays social and moral values, the ability to cope emotionally, integrity, self-efficacy, personal power, and problem-solving ability. She dislikes swearing and fighting; reports fights to others; only fights with friends in defence, if necessary, and finds other friends to play with if the friendship has been broken. Other resilience indicators are perseverance, goal setting, purpose in life, achievement motivation, commitment to learning, optimism and a positive identity. She uses these inner strengths and problem-solving skills, together with a sense of self-efficacy and personal power, to overcome school failure and to envision a bright future related to caring for, and helping others. Her own identification of strengths such as being good at building puzzles and her belief in her ability to exercise control over threatening situations such as being lost, being abandoned, conflict or “being stolen” denotes a positive identity. Dikeledi is cheerful, playful, obedient and sociable and uses these traits to form close relationships with caring adults. Dikeledi’s optimism is evident in that she finds a lot of joy in being able to celebrate important events such as birthdays, New Year and Christmas.

External sources of support that counteract adversities are an acquaintance of her mother; her mother’s boyfriend who compensated for the absence of her own father; her mother’s boyfriend’s children; neighbourhood friends with whom she played during the time of her mother’s illness, as well as many friends of all age groups at school; friends of the opposite sex; the educator at Lebone and God. Perceived domains of positive influence are the church, the school and Lebone.

SUBJECT 2 - Khaya

1. Biographical information

Khaya turned 10 on 19 September 2005, and was admitted to Lebone on the 5th of December that same year. His nine-year old sister also stays at Lebone. Lebone has become their only place of residence since there is no one to collect them during the school holidays, and they do not visit relatives during that time. They lost their mother to AIDS in July, 2001. Khaya is in Grade 4 and speaks Sesotho. English is his second language.

2. Idiographic data

2.1 Communication mapping

Khaya depicted himself as a happy boy playing with his friend, Bophelo. The faces of four friends in the drawing represent the people closest to him. Of the four, Bophelo is his closest friend. After some thought, Khaya mentioned that one of the caregivers in the house is also important to him. Therefore, the researcher then added the drawing of a lady's face to represent the caregiver in the house. He trusts her the most because, whenever she has something, she always shares that with them. Watching videos makes him happy. When others fight with him he feels bad and sad, and usually reports the fights to elders. He says that the death and funerals make him scared. Before answering, Khaya thought hard about what makes him scared and he looked tense. He then said that he had attended the funerals of his grandfather, mother's sister and parents. He said that when he thinks of his parents he feels sad, he cries, and then speaks to the pastor.

Khaya is going to study hard to become a policeman because his uncle was a policeman, and he wants to help people who have broken-down vehicles. He said that he is very good at drawing and loves swimming. He wishes there were a swimming pool at Lebone, and adds that he also wants to have a bicycle "*just to play along the road*".



Figure 5.4 Khaya. *Communication mapping* (2006). Pen on paper, 58 x 81cm

2.2 River of life

The translator explained the task to Khaya. First, he was asked to draw the flow of the water in the river. He depicted his river repeatedly flowing up and down. He said his river flows up because his mother bought him toys. His river flows down when his family members passed away. His father passed away when he was five years old, his mother when he was seven, his grandmother when he was nine, and his grandfather when he was ten. At the time of their death he cried and thought of the cross. He attended church and this made his river flow up again. When he is in church he thinks about the family he lost. After his parents' death, Khaya stayed with his grandfather who cared for him. His grandfather was the last family member to pass away. When he died, Khaya was scared and cried. He was told, presumably by family members, not to cry "because God has taken him." At this point, Khaya seemed very upset. The researcher comforted him and they spoke about what he thought he was good at and of becoming a policeman one day. Khaya sat on his hands from time to time during the session, but seemed more relaxed than during the previous interview.

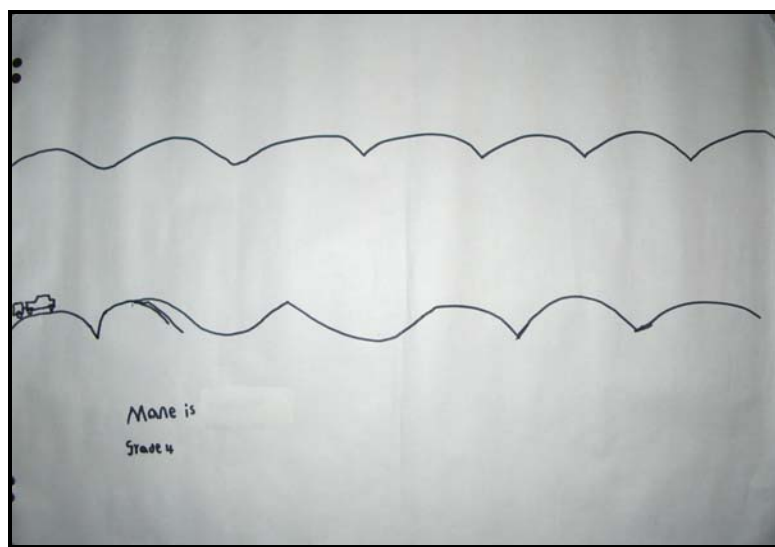

Figure 5.5: Khaya. *River of life* (2006). Pen on paper, 58 x 81cm

2.3 Happy and sad

Khaya greeted the researcher and appeared much more responsive. Instead of drawing, he chose to first talk about the saddest event in his life: “*when I was beaten.*” Khaya was nine years old when the incidence occurred at his uncle’s house. His uncle grabbed him, pushed him down, and used an electric cord to beat him on his back and on the back of his legs. No one intervened to stop the beating. His uncle beat him because he had forgotten to buy bread. He was sent to buy bread after he had been beaten. He was beaten very hard and thought “*it was not fine because I had colour, colours.*” Khaya wanted to report his uncle to the police, thinking that he did not deserve the beating and that it had not been fair. Khaya’s parents had already passed away at the time. He did not feel comfortable with the idea of visiting his uncle again. Besides, he said, he was at work and would only be back home at four o’clock. He did not want his uncle to come to Lebone either. He did not want to see him.

Khaya recalled the day his mother died. His grandparents and younger sister had been there that day. “*She was sick, and I was there, I saw her there. She was sleeping in the other bedroom next to ours. We were sleeping in the room and she was sleeping in the other room, and then she called me and asked where is granny? My granny came, but it was late in the evening. Then after my granny arrived then she passed away, my mother died.*” He knew she had passed away because “*I saw her, because she was not talking, she was just opening the eyes and the mouth also was open.*” He felt sad. “*My granny phoned my uncle then my uncle phoned Moshasha, Moshasha is the mortuary people.*” Of the two events Khaya spoke about, he chose to draw a picture of the time when he was beaten.

Khaya thought that there was always someone to help him. He specifically referred to his grandmother, and three cousins. Khaya referred to his cousins as his brother and two sisters. The one “*sister*” is attending high school in town, the other “*sister*” is staying at a hotel, and his “*brother*” stays in his grandfather’s house. He took over the house when his grandfather passed away. “*To work*” made Khaya proud. “*Cleaning up, example like, when my uncle used to clean the garage I used to help him then I’ll take other stuff to be behind the garage, then if I’ve done good then he’ll always reward me, money.*” Khaya said that if he works hard and fails a test, he will just study harder, and try again. If he gets lost he will cry, and then ask people for help. He finds it easier to talk to some strangers rather than to others. He believes a lot of people do not like him, particularly adults - “*mammas*”, because “*when other kids were being silly, and then she notices them she’ll always include you even if you didn’t do anything bad, so I felt like she didn’t like me.*” He feels that this is wrong. He drew a “*happy picture*” of him playing soccer. Again he said that he wants to become a policeman one day. At the end of the interview he said that he enjoys drawing again.

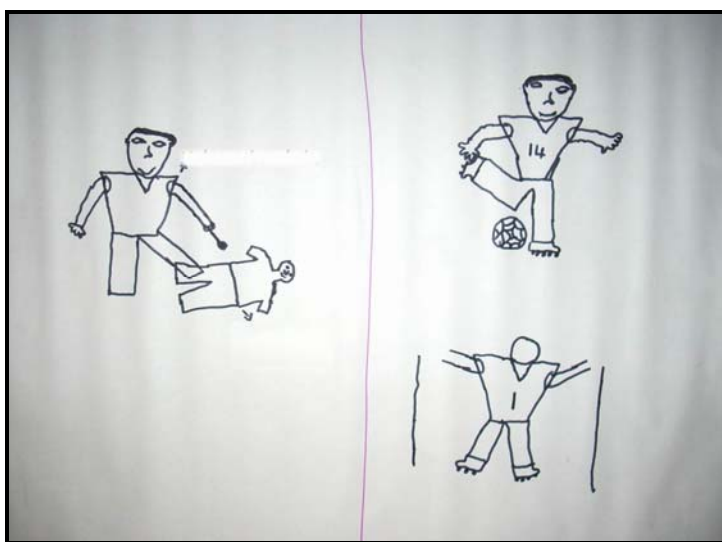

Figure 5.6: Khaya. *Happy and sad* (2006). Pen on paper, 58 x 81cm

3. Interviews held with key informants

The interviews with the social worker, two of the carers and the pastor at Lebone, as well as a teacher at Shanon Intermediate School revealed the following:

3.1 Social worker

The social worker had no information on Khaya's father. His mother had been a single mother and had stayed with her children at her father's house. First, Khaya's grandfather passed away, then according to Khaya's aunt, his mother passed away in 2001. After her death, Khaya and his sister moved to stay with their uncle. Their aunt accused them of stealing food and money from the home, and "*all the bad things. Only to find out when I take them to Lebone they didn't even steal a piece of bread. They are the good children, both of them.*" The aunt did not allow the children to touch or do anything at home. She told the social worker that if the children stay with her any longer, she would kill them. The aunt then left the children at Lebone with a boxful of clothes. Khaya and his brother asked the social worker not to visit their aunt and uncle again during the school holidays because they are happy at Lebone. Khaya's aunt occasionally still visits Lebone, but the children avoid her when she is there. "*They just walked far from her.*" The social worker said that the two brothers had a good relationship. She described them as quiet children and said that they do not have any problems. If they needed anything, they would always come and ask.

3.2 Caregivers

To the carer, Khaya is a difficult child because he is not talkative. He seems shy to her. She found that he is lazy because he does not run around and play a lot with the other children. He just sits and pushes toy cars back and forth over the sand with some of the smaller children, in a dreamlike manner. She said that he struggles with Maths and English at school.

The other carer found it difficult to understand Khaya. She agreed that he is a quiet child. Khaya and his sister are very fond of each other and often talk. Both of them love playing with the babies in the house. Khaya never fights with the other children, and always reports to the carer those children who want to pick a fight with him. He loves playing soccer.

3.3 Pastor

When the pastor fetches the children from school, Khaya loves to sit in the front seat. The pastor said that Khaya reminds him of a bodyguard. "*He won't allow the other children to touch anything in the car and he will look at me by the look of, if you can read that look, that will be saying, Pappa George are you satisfied, are you satisfied?*" Khaya's quiet behaviour concerns the pastor at times, but he has come to realise that this is Khaya's nature. He describes Khaya as a well-mannered child who often disciplines the other children.

3.4 Teacher

Khaya is a quiet boy at school and the teacher likes him because “*he liked to do his work.*” He behaves in class and she reported that, except for struggling with Literacy, he has no other problems. She said that because Sesotho is not his first language he struggles with reading. He interacts with the other children, but has a good friend in the location with whom he plays most of the time.

4. Identified themes and categories

Table 5.3 presents the identified themes and associated subcategories from the information concerning Subject 2. The following table only presents this subject’s responses to the external realities listed in Table 5.3.

TABLE 5.3: Identified categories and subcategories (Subject 2)				
	External realities (stressors)	External supports	Inner strengths	Interpersonal, problem-solving skills
Communication mapping, River of life, Happy and sad.	<p>Serious illness of family member</p> <p>Loss of primary caregivers and other family members</p> <p>Death and funerals</p> <p>Anti-social values of family member</p> <ul style="list-style-type: none"> • Violence <p>Physical abuse by family member</p> <p>Negative gender-based relations</p> <p>Relocation</p>	<p>Supportive Relationships</p> <ul style="list-style-type: none"> • Uncle (adult role model) • Grandfather • A close friend • Four good friends • Caregiver in the house • God • Extended family (grandmother and three cousins) <p>Supportive environments</p> <ul style="list-style-type: none"> • Church 	<p>Faith</p> <ul style="list-style-type: none"> • Healing • Comfort <p>Morality and social values</p> <ul style="list-style-type: none"> • Against violent behaviour (i.e. fighting, beating others) • Judgement • Fairness <p>Emotional management</p> <ul style="list-style-type: none"> • Able to recognise feelings and control undesirable feelings <p>Achievement motivation</p> <ul style="list-style-type: none"> • Motivated to do well in school <p>Optimism and positive identity</p> <ul style="list-style-type: none"> • Positive view of personal future • Happy disposition <p>Trust</p> <ul style="list-style-type: none"> • Caregiver in the house 	<p>Problem solving ability</p> <ul style="list-style-type: none"> • Able to find or ask for help • Will work harder after failure <p>Self-efficacy and personal power</p> <ul style="list-style-type: none"> • Belief in ability to exercise control over future and threatening situations <p>Goal setting, purpose in life and commitment to learning</p> <ul style="list-style-type: none"> • Related to helping others <p>Constructive use of time</p> <ul style="list-style-type: none"> • Playing • Sports • Working • Watching videos <p>Perseverance</p>
Additional identified subcategories				
Social worker	<p>Single-parent household</p> <p>Abusive relative</p>	<p>Supportive relationships</p> <ul style="list-style-type: none"> • Brother <p>Supportive environments</p> <ul style="list-style-type: none"> • Lebone 		
Carers				<p>Communication</p> <ul style="list-style-type: none"> • Sister
Pastor			<p>Morality and social values</p> <ul style="list-style-type: none"> • Brother 	
Teachers	<p>Learning difficulties</p> <ul style="list-style-type: none"> • Reading 	<p>Supportive Relationships</p> <ul style="list-style-type: none"> • Close friend from the location 		

TABLE 5.4: Responses to stressors or adversities (Subject 2)		
External realities (stressors)	Initial thoughts, behaviour, feelings or emotions	Present thoughts, behaviour, feelings or emotions
Death, funerals, and loss of primary caregivers and other family members Relocation	When his family members died, Khaya thought of the cross . He attended church where he thought of the family he lost . When Khaya's grandfather passed away, Khaya cried and felt scared . When he realised that his mother had passed away, he felt sad .	When he thought of his parents he felt sad . He would cry often and then go and speak to the pastor . The death of someone and funerals makes him scared . Khaya is not very talkative and seems shy and lazy because he does not run around and play a lot with the other children. He just sits and pushes toy cars back and forth over the sand with some of the younger children , in a dreamlike manner . One of the carers described him as a quiet child .
Anti-social values of family member <ul style="list-style-type: none"> • Violence Fighting Physical abuse by family member	Khaya thought that the beating he received from his uncle was unfair and he wanted to report him to the police .	When others fight with him he feels bad and sad . He usually reports fights to elders . He does not feel comfortable with the idea of visiting his uncle again. He does not want him to come to Lebone either. He does not want to see him . He never fights with the other children and always reports to the carer other children who want to fight with him .
Negative gender based relations	He thinks that the mammas who falsely accused him of wrongdoing do not like him .	According to Khaya, many people do not like him, particularly "mammas" . He feels that it is not right of the mammas to include him when he has not done anything wrong .
School failure (hypothetically speaking) Learning difficulties <ul style="list-style-type: none"> • Reading, Maths and English 		He will study harder and try again .

The information regarding adversities and stressors only relates to Khaya's family and home environment: illness, death, the absence of primary caregivers, as well as the loss of his grandparents, funerals, physical abuse and false accusation by adults. Khaya has also been maltreated by his aunt and has been relocated to Lebone.

In counteracting these adversities and stressors Khaya displays strong interpersonal and problem-solving skills in that he establishes support networks with people around him and makes constructive use of time by watching videos, playing (particularly with younger children), doing sports, helping others and working. He finds joy in these activities, as well as pride in his work. Khaya's faith has sustained him through multiple losses and grief. Khaya's projections for a happy future indicate resilience characteristics such as goal-setting, commitment to learning, self-efficacy, optimism and purpose in life. His sense of efficacy, commitment to learning and perseverance is also evident in his proposed strategies to overcome difficulties such as being lost and failing a grade at school. Other resilience characteristics such as emotional management, specifically referring to the ability to recognise and control undesirable feelings, optimism, viewed in terms of a "happy self portrait," and moral standing, regarding physical abuse were also conveyed during the interviews. Morality and social values, too, were displayed in Khaya's communication and behaviour towards other children. Open communication is used to express needs to adults.

According to Khaya, his mother passed away before his grandfather died, but the social worker claims that Khaya's grandfather passed away before his mother died. Although this discrepancy may influence the extent of support that Khaya received from his grandfather, the fact remains that Khaya's grandfather functioned as an asset in his life, particularly in terms of compensating for the absence of his father. Even though Khaya had experienced adversity within his extended family, the family provided support in terms of temporary shelter and food. Khaya also established a fulfilling working relationship with his uncle. Khaya's present support network consists of four good friends, his sister with whom he often communicates, a best friend, and despite negative gender-based relations, he has established a trusting relationship with one of the caregivers from Lebone. This support network includes a friendship outside Lebone with a boy from the location whom Khaya met at school. In the wider environment of institutions or the exosystem, the church has influenced Khaya's ability to cope with losses in his life.

SUBJECT 3 - Thato

1. Biographical information

Nine-year old Thato was born in Botshabelo on 20 April 1997, and is in Grade 2. She lost both parents to AIDS and has been in Lebone since 6 September, 2004. She spends the school term at the centre with her 8-year old sister, and two brothers, aged 12 and 4. During the school holidays, they visit their grandmother who lives in the nearby township. Her home language is Sesotho and she speaks English as a second language.

2. Idiographic data

2.1 Communication mapping

Thato entered the room, greeted the researcher with a shy smile and looked down. She agreed to help with laying the blankets on the floor, and stood silently with her hands folded behind her back, watching as the researcher took care of the other preparations. When the translator came, Thato looked curious as to what was going to happen, eagerly found a place to sit, and took off her shoes. The translator explained the activity to her and she willingly took part.

Thato depicted herself as a happy, laughing little girl, playing hopscotch in the house at Lebone. She told the researcher that she is very good at hopscotch. The faces she drew of eight friends (all female) and a caregiver in the house at Lebone represent the people who are most important to her. Thato loves her friends because they play together. Her favourite game is skipping, and she enjoys playing a similar game called "gati." Of all her friends, Tlholo and Poelo are the most important to her. Thato believes that Poelo loves her because they play cards together and "*she doesn't report*" her when she does something wrong. Therefore, of all her friends, Thato loves Poelo the most. Thato trusts her, but cannot tell her just anything, because Poelo once found her playing with other friends in class at school instead of reading and writing. Poelo then lied and said that she was going to report her to the teacher, but never did. Thato explained that she trusts Tlholo more. They can talk about anything because they love each other. Her strong affiliation with all her friends is displayed by the fact that she considers them as family. She never mentions her two biological brothers. The only true family she mentioned are two older ladies, but their relation to her is not quite clear. She explained that they are not aunts, but "*like cousins*" to her. Thato likes the caregiver "*because she looks after us and makes us nice food.*" Her favourite food is rice, pumpkin, beetroot, potatoes and meat.

When asked what she would do if ever she found herself in a difficult situation or got lost, Thato explained that although she finds it difficult to talk to strangers, "*if I see a sister or mamma on the road I can tell them*

that I'm lost and then they'll take me to the police station and then the police station will take me home or phone home." She felt that most people like her and said that she has never done "silly things, silly stuff". If she had something difficult to do and she struggled with it, she said: "I won't feel fine," but "I can ask those that are able to do things to help me."

At the end of the session she said that she feels happy because "I've drawn smart." Her answer to what had made her happy in life was: "it's because I play nice." About her future Thato said: "because I've learnt to learn, to read and work," her vision is to become a nurse. She said that she had enjoyed drawing, and could draw again. Before she left she said that there is something that she wants to say to the researcher. She smiled and said: "I love you."

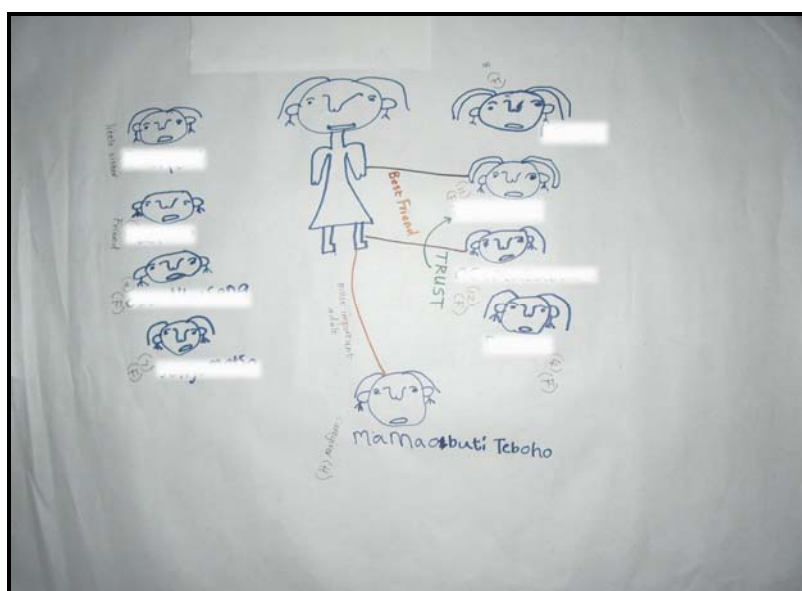

Figure 5.7: Thato. *Communication mapping* (2006). Pen on paper, 58 x 81cm

2.2 River of life

On the day the second session was held it was extremely cold. When Thato entered the room the researcher greeted her and she cautiously, out of her own, joined the researcher in front of the heater. She seemed surprised when the researcher held both her hands to feel how cold they were. They stood by the heater waiting for the translator to come. Every now and then Thato held out her hands to feel the heat from below, apparently relaxed and content with the silence between them. When the translator came everyone found a place to sit, and she explained that day's task to Thato.

The instrument was slightly adapted to improve the quality of the obtained information and to facilitate comprehension of the task. The task was broken down into segments. First, Thato talked about the first three years of her life. She said that they lived in Botshabelo. Most of what she could remember, she recalls from photographs. One photograph was of her mother carrying her as a baby and the other of Thato when she started to crawl - a "*smart*." picture of her wearing a "*white dress and something that made it two piece*." Her favourite toy was a "*girl doll*," named Ntswaki. The doll was smartly dressed in purple pants and a pink top. She played with Ntswaki, in an imaginary house, consisting of a bathroom, bedroom, "*make believe*" pillow, and blanket. She loved to play with her doll on a Sunday, mostly in the afternoon, because that was when she felt happy. She depicted her river flowing up at that time and made a drawing of her as she was then, to represent the first three years of her life. The subsequent years were dealt with in the same way.

At the age of five, she still lived in Botshabelo with her mother, uncle, granny, sister and niece, Maggie. At first, her two brothers were not included. When asked about them, she acknowledged that they had lived there too, but said that they played outside. Everybody lived happily together; they never fought or were cross with one another. She added that then "*it was nice, I was independent, I could speak now properly, I could use the bathroom, toilet*." Her river still flowed up, and she drew a picture of her, her younger sister and Maggie playing skipping to represent that time. At the age of seven she relocated to Lebone, because "*mamma Lulu asked my grandmother if we could come to Lebone because our mother passed away*." She told that she saw her mother when she was ill, lying in bed. Her grandmother gave her the news of her mother's death. Thato then crouched forward, covered her face with her hand, and cried. The researcher knelt next to her, held her and rubbed her back to comfort her. Eventually Thato said that she misses her mother very much. Further questioning by the researcher gently shifted the focus from her mother to the future.

Thato foresaw her river flowing up, at the age of fifteen. She said that she was still in school and did not want a boyfriend then. After school, again, she said that she is going to study hard to become a nurse. She wants to help "*sick people who have colds and flu*," by "*giving them medication*." Thato added that she wants to get married, have three children, live in a three-bedroomed house with a kitchen and sitting room, painted red, purple, green and blue, and drive a red Toyota car.

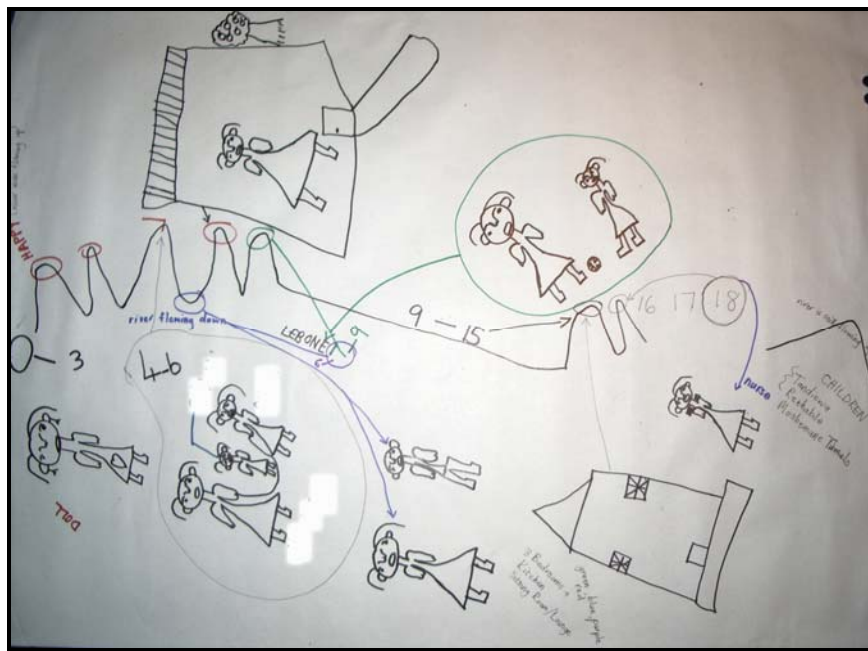

Figure 5.8: Thato. *River of life* (2006). Pen on paper, 58 x 81cm

2.3 Happy and sad

The task was also slightly adapted for this session. Thato was asked to close her eyes, clear her mind and relax. After a while the researcher asked her to carefully listen and name the sounds that she could hear. When she appeared completely relaxed and self focused she was asked to recall the event that hurt her the most in her life. Twice she said that there was, or had been nothing. The researcher then asked her whether there had been something that had made her sad or cry. Although she could not picture that in her mind, she said that *“it was when my mother was sick.”* Thato said that she has happy memories of her mother, and drew a picture of her. She related that she still thinks of her mother a lot, and finds it difficult some days, living without her. *“Thinking about how they are being looked after at Lebone”* made it easier for her. She agreed that there are many people around her who love and care for her at Lebone, and that she has a lot of friends to play with.

Again the researcher asked her to close her eyes and think of something that would make her very happy. She wished to go to Botshabelo to visit Maggie whom she misses very much. She said that she is her best friend, and had last seen her before she started school. She drew a *“happy picture”* of her visiting Maggie, and of them playing *“gati”* together.

Lastly, Thato was given the option of drawing a *“goodbye picture,”* as this was the last session. She drew a picture of her skipping, and smiled when the researcher said that she would remember her that way. The researcher thanked her for taking part in the study and Thato enthusiastically gave her a big hug.

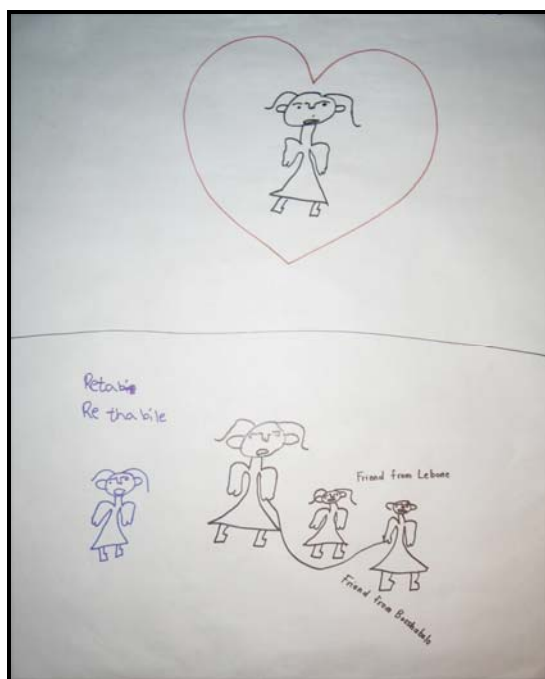

Figure 5.9: Thato. *Happy and sad* (2006). Pen on paper, 58 x 81cm

3. Interviews held with key informants

This section presents information gathered during the interviews with the social worker, two of the carers and the pastor at Lebone, as well as a teacher at Shanon Intermediate School.

3.1 Social worker

Thato's mother did not marry. Her father was her mother's boyfriend and did not live with them. Thato's grandmother relocated to Johannesburg when her mother was still very young. Her mother then stayed in Bloemfontein and was raised by her mother's sister. When Thato's mother had fallen ill and passed away, her grandmother returned to Bloemfontein. Her grandmother's sister then asked her grandmother to take care of Thato, her two brothers and sister. Thato's grandmother lived in a small shack, had no child support grant, and struggled to cope with the care of the children. The social worker from Lebone removed all the children, except Zandi, Thato's eldest brother. Thato was not yet in school as she was only five years old. The family told the social worker that Thato would sometimes be quiet and would then just want to be left alone.

3.2 Caregivers

Thato spent a lot of time with the other carer. She would just ask her questions such as where she lived, her age, how many children she had, their gender, and why she had come to work at Lebone. She liked playing and making jokes, always seemed happy, and never cried or shouted.

According to the other carer, Thato enjoys playing with the older children. She loves joking, playing and writing. Over weekends when they “played house” Thato pretended to be at school and would sit and write.

3.3 Pastor

The pastor is very fond of Thato. *“I like that girl. She touched my heart.”* The pastor noticed that she took good care of herself and always smiled. Like Khaya, she too is well-mannered. The pastor said that he often asked himself how such a girl had come to be at Lebone.

3.4 Teacher

The teacher described Thato as a very quiet girl. Her school work is good at times and then not so good at other times. Thato neglects to do her homework, does not always listen, and lacks concentration in class. She has a best friend at school who is also at Lebone. The teacher noticed that Thato sometimes becomes quiet, seemingly worried and deep in thought. At such times, she does not speak to the teacher and the teacher had not enquired about her mood either. Thato easily cries when children teasingly hit her, and always reports such instances to the teacher.

4. Identified themes and categories

Table 5.5 presents the identified themes and associated subcategories from the information concerning Subject 3. Subsequently, Table 5.6 elaborates on the external realities listed in Table 5.5 by way of a presentation of the child’s initial (i.e. at the time of the adversity) and present (i.e. at the time of the interview) thoughts, behaviours and feelings or emotions.

TABLE 5.5: Identified categories and subcategories (Subject 3)				
	External realities (stressors)	External supports	Inner strengths	Interpersonal, problem-solving skills
Communication mapping, River of life, Happy and sad.	Serious illness of family member Loss of primary caregivers Death Relocation	Supportive Relationships <ul style="list-style-type: none"> Two close friends Six good friends Caregiver in the house Supportive environments <ul style="list-style-type: none"> Lebone 	Morality, social values and restraint <ul style="list-style-type: none"> Values loyalty Love Values honesty Values independence Avoids early involvement in serious relationships with the opposite sex Emotional management <ul style="list-style-type: none"> Able to recognise feelings and control undesirable feelings Creativity and Imagination <ul style="list-style-type: none"> "Make-belief" Achievement motivation <ul style="list-style-type: none"> Motivated to do well in school Optimism and positive identity <ul style="list-style-type: none"> Positive view of personal future Happy disposition Most people like her Fair play Photographs (positive childhood memories) Resistance skills <ul style="list-style-type: none"> Avoids doing "silly stuff" Trust <ul style="list-style-type: none"> Fair play 	Problem solving ability <ul style="list-style-type: none"> Able to find or ask for help Will work harder after failure Self-efficacy and personal power <ul style="list-style-type: none"> Belief in ability to exercise control over future and threatening situations Goal setting, purpose in life and commitment to learning <ul style="list-style-type: none"> Related to helping others Constructive use of time <ul style="list-style-type: none"> Playing Games Working Perseverance Communication <ul style="list-style-type: none"> Friends Emotion/Feelings
Additional identified subcategories				
Social worker	Separation from siblings Poor care Poverty	Supportive Relationships <ul style="list-style-type: none"> Biological grandmother Grandmother's sister 		
Carers			Humour <ul style="list-style-type: none"> Making jokes Interest in others <ul style="list-style-type: none"> Carer 	Communication <ul style="list-style-type: none"> Apologises when she has done something wrong
Pastor			Morality and social values <ul style="list-style-type: none"> Well-mannered 	
Teachers	Learning difficulties Teasing	Supportive Relationships <ul style="list-style-type: none"> Teacher 		Communication <ul style="list-style-type: none"> Reports teasing

TABLE 5.6: Responses to stressors or adversities (Subject 3)		
External realities (stressors)	Initial thoughts, behaviour, feelings or emotions	Present thoughts, behaviour, feelings or emotions
Serious illness of family members	She was sad and cried when her mother was ill.	Thato has happy memories of her mother. She thinks about her a lot and finds it difficult some days, living without her.
Death and loss of primary caregivers Poor care	Thato was sometimes quiet and then just wanted to be left alone.	During the interview Thato crouched forward, covered her face with her hand and cried. She said that she misses her mother very much. Thoughts of how she was cared for at Lebone made it easier for her.
Relocation		She wishes to visit her friend, Maggie in Botshabelo whom she misses very much.
School Learning difficulties		She neglects to do her homework, does not always listen, and lacks concentration in class. The teacher noticed that Thato sometimes becomes quiet, seemingly worried and deep in thought. At such times, she does not speak to the teacher and the teacher does not enquire about her mood either.
Being lost and other difficulties (hypothetically speaking)		Although she finds it hard to talk to strangers, she would ask women to help her if she were lost. If there were something difficult she had to do and struggled with it she would not "feel fine," but she felt that she could ask knowledgeable people for help.
Teasing		She cries and reports the incident to the teacher.

Identified adversities and stressors, namely, the serious illness of a family member, the loss of primary caregivers, separation from siblings, poor care, poverty, and relocation related to Thato's family and home environment. Facing these stressors and adversities, Thato displayed important areas of resilience.

She exhibits self-efficacy and positive identity in own identification of strengths such as creative ability, imagination and fair play. Her future projections suggest inner strengths such as perseverance, goal-setting, purpose in life and achievement motivation. Thato also believes that the academic competence she gained thus far will support her in fulfilling her dreams of becoming a nurse. In turn, these strengths reflect her optimism and positive identity, in relation to her future. Her optimism and positive identity are also evident in that she believes that most people like her, she has positive childhood memories and exhibits a happy disposition. She displays resilience strengths such as morality, social values and restraint, given that she values loyalty, love, independence, honesty, and avoids early involvement in serious relationships with the opposite sex. Resistance skills are evident in that she avoids doing "*silly stuff*." Activities such as play, games, writing and working indicate constructive use of time. Thato uses communication skills and emotional management to solve problems such as mistakes, being teased, being lost or other difficulties in general. Together with these skills Thato uses inner strengths such as a sense of humour, good manners, and an interest in others to form supportive relationships.

Although Thato received support from her grandmother's sister, as well as her grandmother for a short period after her mother's death, her predominant sources of support after this loss are the people at Lebone. There,

she has formed supportive relationships especially with eight good friends and a caregiver. Two of these friends are considered to be her close friends whom she loves very much, and she has established a trusting relationship with one of them in particular. Thato has a supportive relationship with the teacher at school considering that she can report offences committed by other children towards her to the teacher.

SUBJECT 4 - Lebo

1. Biographical information

Lebo, born on 16 March 1997, is 9 years old and in Grade 3. Her mother passed away due to AIDS, but the cause of her father's death is unknown. She was taken up at Lebone on 16 July, 2003. Her grandmother, whom she visits during the school holidays, lives in a nearby township called Bloemanda. She has three older brothers who also live in the township. She occasionally sees them during holiday visits. Lebo speaks three languages: Sesotho (first language), IsiXhosa (second) and English (third).

2. Idiographic data

2.1 Communication mapping

Lebo depicts herself as a happy girl, wearing a necklace that "*Mistress Monond*" bought for her, a top with a big flower on it that mamma Lulu gave her, a hipster which her granny bought her, and shoes given to her by her sister. She portrays herself as happy in the picture because she passed Grade 3. Significant others in her life are her brother and the two caregivers in the house at Lebone, Rakgadi and mamma Teboho. She trusts Rakgadi the most because she once gave her money to keep, and gave it back later when Lebo asked for it. She also feels that she can talk to her. She mentioned that mamma Teboho cooks for them, and that her favourite food is beetroot, spinach, pumpkin, fried onion, meat and rice. Mamma Teboho is the most important person to her "*because she loves me. When we are all together then she calls us and then gives us food, she gives us sweets, sometimes she even calls us to ask if we need food. If we say yes, she gives us food.*" Lebo described her twenty-nine year-old brother as "*dark like me, when people looks at him they always ask whether we are twins, we look the same.*" She loves him because he does not smoke or drink alcohol. It meant a lot to her when on one occasion he helped her and some friends with maths. In addition, she wrote down the names of four people at Lebone whom she considers important: "*Mistress, mamma Lulu, mamma Andri and pappa George.*" About mamma Andri she said: "*She always takes us to school and fetches us after school. Sometimes we ask her to take us to MacDonalds, then she always promises to take us.*" The most important friend to her is Tsegofatso. "*Tsegofatso is only five years old, so I like the way when we talk together, or when other people asks her questions, I like her confidence.*" She mentioned the name of another friend, a nine year-old girl, with whom she enjoys playing hopscotch. They always have a lot of fun together. Her friends make her very happy and they enjoy laughing together. What Lebo likes about this friend is that when other children fought with her at school, she told them to stop. When they did not listen to her, she reported them to the teacher. Lebo believes that all people love her, and finds it easy to talk to strangers.

If she were in a difficult situation, or if she lost her way, she would phone someone if she had their numbers. Otherwise, she would cry and say that *“I can kill myself. If I have the energy, I can get a knife nearby and kill myself like the two sisters that killed each other with knives.”* She did not see this happen, but had heard the news from her grandmother who had heard it from people in the neighbourhood. Lebo felt sad after she heard the story. The story is about two sisters who fought over the one sister’s child. *“The big sister came with her baby. They slept because it was in the evening. And then the big sister took the child to the crèche the next day, and when she came back they fought over the child. Then the big sister was saying that it’s my child. She had said that her sister had not looked after the child. Then the younger sister said, it’s your child, but you’re not looking properly after it, the one that’s taking care of her. Then the big sister started to hang herself. Then, after the big sister hanged herself, and then the little sister saw that she was dead, she also hanged herself. Then the people called their mother. When the mother also saw that, the mother took the knife and stabbed herself, because her kids that she loved so much killed themselves, so she thought she better kill herself too.”* She then corrected herself and said that the sisters had not killed each other with knives, but *“hanged themselves one by one.”* Lebo feels angry when she talks about the event. She specifically explained that *“that thing that the child was left alone makes me angry.”* Lebo said that she had never felt alone. The researcher then asked her whether she thought people would feel sad if she killed herself, to which she replied: *“people won’t feel happy.”* She said it wouldn’t be right to hurt herself like that if she were lost. Instead, she suggested that she could contact someone, if she knew their numbers and there was a Telkom phone nearby. If not, *“I can end up in the street, and the people that kidnap the children can kidnap me,”* and then *“I’ll just cry.”* The researcher asked her if she would allow those people to kidnap her, and she said that she would phone the police. Lebo said that the four people she could speak to if ever she had a problem are “Mistress, mamma Lulu, mamma Teboho, and Rakgadi.” Although she thinks that this is wrong, she cannot think of anything else people can do instead of fight when they have differences or are angry. Then she agreed that talking about anger is a solution. Lebo also thought that it is better to talk about problems or feelings rather than to hurt oneself *“because people would not like me to kill myself.”* She agreed that many people love and care for her, such as those she drew. Lebo suggested that people could ask for forgiveness if they do something wrong. Then everyone would be happy, and feel better.

To conclude the session, the researcher referred to the necklace in Lebo’s picture. Lebo said that it reminds her of Jesus Christ. According to Lebo, He felt unhappy and became angry with people who fought. *“He can say stop fighting or swearing each other because it’s a bad thing.”* He would not forgive them *“because they are doing things that they are not supposed to.”* If they apologised, He would forgive them. She thought that He is strong, but *“won’t fight back because He is a child of God.”* That thought makes her happy and safe. She said that when she wears the necklace she thinks of Him being close to her.

She enjoys and does well at school. She wants to become a nurse and look after sick people. At the end of the session the researcher questioned her mood and she replied that she is *“just quiet,”* but happy, and would like to draw again. The researcher has come to know Lebo as an extremely shy, perhaps even a little withdrawn, but intelligent girl. Although Lebo agreed to do all the tasks, it seemed like an effort to her at times. She would sigh deeply and pause for a moment before starting to draw or answer a question.

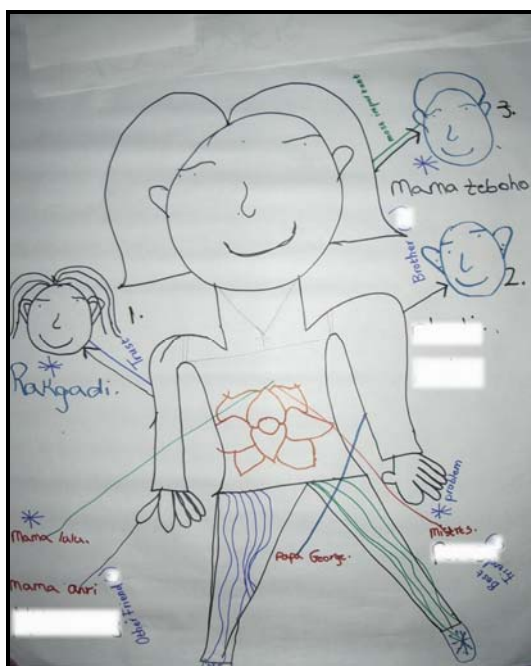

Figure 5.10: Lebo. *Communication mapping* (2006). Pen on paper, 58 x 81cm

2.2 River of life

Lebo greeted the researcher in a friendly manner and told her about her day at school. It had been a good day, and she had been awarded “*excellent*” for the subjects she had written. The translator then explained that day’s task to her.

Lebo was born in a township called Bloemanda. She recalls playing with rattles and some dolls between the ages of one and three. Her doll looked “*smart*” with long, straight, brown hair, and wore a long pink dress with pleats. When she was a little older, her granny or brother always took her to crèche in the mornings. She remembers her teacher’s name and says that she had friends there. She recalls that “*one day at crèche, I was attending crèche, then it happened one day that the teachers at school beat me. When they were giving food, they always said that I must finish my plate, and if I didn’t finish it, then they’ll use a dishcloth to beat me.*” She had trouble finishing her food because she says: “*I was feeling full.*” She became afraid of being beaten repeatedly, so “*I went back home and told my mother. My mother wrote a letter to the teachers.*” That made her feel happy because everybody had then apologised and never hit her again. Lebo drew a picture of the crèche. At the time she was living with her granny and three brothers. Her mother and father lived in their own house, and she visited them from time to time. Her river flowed up.

Lebo relocated to Lebone at the age of five, and when Lebo was six, her mother fell very ill. She recalls that her mother hit her with a shoe once because she played with her clinic card. Lebo’s river flowed down at the

time. *“I just used to see her sleeping in bed. She was sick like Ndile [one of the children that recently passed away at Lebone]. So she was, I can say, she was very weak.”* Lebo felt afraid and unhappy. She was afraid to tell her friends, because she thought they would laugh at her. She only spoke to her granny and brothers, because they lived with her. *“My mother used to always tell me to go and tell granny that she’s sick, so we were always discussing about my mother being sick.”* Her mother passed away in hospital. *“I was there, but I did not know what happened, my granny told me that my mother has passed away.”* On hearing the news of her mother’s death, Lebo thought about how much her mother loved her. *“We used to go to town and then she would want to buy me maybe dolls or something, then I’ll have, she always said that I must choose which one I like and then whatever I choose, she will buy me.”* She last saw her father when she was still very small, and the cause of his death is unknown to her. The reason given for her being at Lebone is *“because I was orphan. That’s why I came, I don’t have parents.”*

Between the ages of seven and nine, her river flowed up and down. Sometimes her friends fought with her. They teased her, and told her that her eyes are brown. When the researcher asked her about the colour of her eyes she said that *“as I look at them they are brown.”* She thinks they are brown because she has sore, *“problem eyes.”* She does not know the cause thereof, but says that she often gets *“pain in the eyes and then I’ll feel like rubbing, scratching them like that.”* Although her friends teased her, she enjoyed going to school. She loves being at Lebone, and has made lots of friends. She drew a picture of Lebone to signify her river flowing up. She depicted the administrative building, and the tree that grows next to the administrator’s office. *“Me and my friends, like Mathabo, we like to sit under the shade of the tree when it’s sunny, when we sit outside.”*

She pictured a bright future. She was going to pass all her grades in school, go to University and study hard to become a nurse. She drew a picture of the house she was going to buy. It has a table and chairs, a small bathroom painted green, and a bedroom painted red. During the session she seemed tense at times, reluctant to answer some of the questions, and draw some of the pictures.

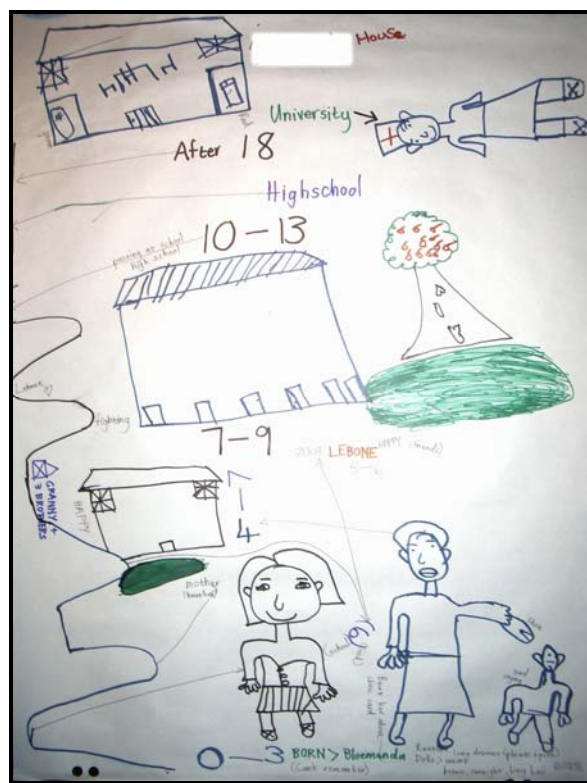

Figure 5.11: Lebo. *River of life* (2006). Pen on paper, 58 x 81cm

2.3 Happy and sad

Again Lebo told of her day at school. It had been “*fine*.” She had been awarded “*good*” for most of her subjects and “*excellent*” for the others. She said that they had played, and had run around during break. The researcher asked her about her experience of the previous session and she said that some of the questions had been difficult. She had become afraid of being asked questions. The researcher acknowledged it as such, and reassured her that she had done well in the previous session, and that there was no need to feel afraid. If necessary, the researcher would rephrase difficult questions during this session, and she was under no obligation to answer all the questions. The translator then explained the task to her.

She closed her eyes, and seemed to relax a little. She heard the sound of people talking, a woman’s voice, the recorder, and birds outside. When asked about the thing that hurt her or had hurt her, she answered that the teacher had given them a hiding at school that day and that it had really hurt. She pulled the hood of her sweater over her head. She was kneeling on the floor and started to rock back and forth. During questioning she kept on pulling the hood even further over her head. She said that the death of her sister is something from her past that hurts her. She opened her eyes and appeared very sad. She dropped her eyes to the floor and paused for a while when the researcher asked her to draw her “sad picture.” Eventually, she slowly

collected the pens in her hands, sighed, and said that she did not know what to draw. The researcher suggested that perhaps she could depict the feeling of having lost her sister, but she did not agree. The researcher then asked a few more questions about her sister. Lebo answered that when she went home for the holidays, she heard from her grandmother that her sister had been ill and passed away. She died in Queenstown during the June holidays. Lebo did not know her sister's name or how old she was. If she could give her a name, she said that she would just call her "Ausi." Lebo had not attended the funeral as she had already returned to Lebone. The researcher asked if she would draw a picture of her sister. Without answering, she picked up a pen, drew quickly, apparently careless, frustrated and angry. She said that she thought of her sister and how she loved her, when she drew the picture. She recalls that they played together, but did not know of any specific games. She says that there is a photograph taken in Queenstown of her sister wearing colourful clothes at home. The photograph is not her own, but she had seen it in an album. She misses playing with her the most. She then remembered that they played "gati" together. The researcher then asked her about what had happened at school that day. *"The teacher came, we didn't notice that the teacher was coming, so he found us playing and making noise. He just came in, put his books on the floor, and started giving us a hiding with a stick, on our hands. It didn't really hurt very much."*

Lebo closed her eyes again. She could name anything that would make her very happy. She wished for *"playing things. Poppies and toys, dolls,"* and *"a kitchen set, like pots, spoons, kitchen set."* She wanted someone to buy that for her. She opened her eyes. She then said that she wants "adults", in particular a sixteen year-old girl from Lebone who had helped her before, to help her with schoolwork. She said that she finds homework difficult. She drew a picture of the kitchen set in which she was going to cook rice and meat and the doll which she was going to call "Barbie."

Lebo seemed a little more relaxed again, and the researcher asked more questions relating to her sister and parents. She said that she cried when she heard the news of her sister. Again she said that she thought of how much she loved her, but then said that she was in pre-school at Lebone when she heard the news. The teacher asked her why she was crying. She spoke to children at school and other staff members from Lebone about the death of her sister. She said that *"we were just talking,"* and that she had forgotten what they had told her. It makes her sad being without parents. She thinks of them often. Although she misses both her parents, she missed her mother the most. Lebo remembers her mother's name and says that she misses her because *"she loved me."*

For a moment, the researcher shifted the focus to her doll. She said that it must be a white doll, and have *"extra clothes with colours."* The researcher drew a heart around the picture of her sister. At first she thought that it represents her sister's heart, but then said that it is hers. When asked where her sister was, she answered that she had passed away. Only after careful consideration, she said: *"in my heart."* If there were anyone else she could add, she said that it would be her parents. She did not want to draw a picture of them in the heart, but agreed to write their names. She looked at the heart and the researcher asked her what she was thinking. She said: *"niks [nothing]."* She agreed to draw a "good bye picture." She depicted herself saying *"sala hantle,"* which means "go well," and a flower that was *"just a symbol of good bye."* The

researcher thanked Lebo for her efforts, and asked if she could give her a hug. She smiled shyly, got up and put her arms around the researcher, and then quietly left the room.

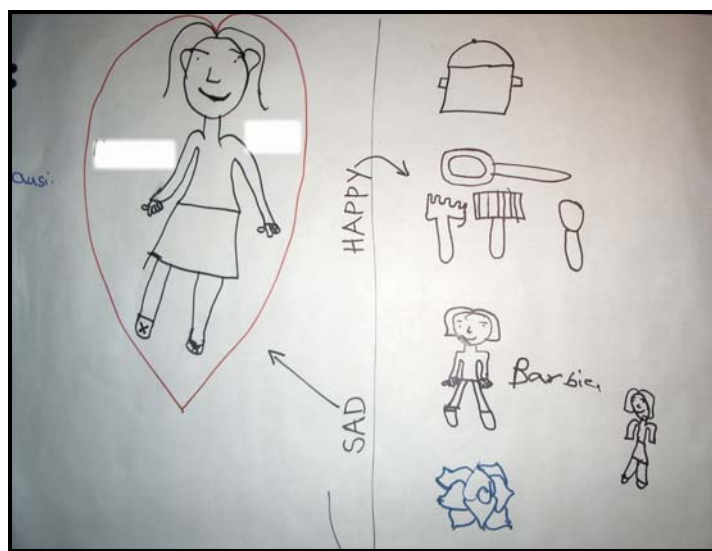

Figure 5.12: Lebo. *Happy and sad* (2006). Pen on paper, 58 x 81cm

3. Interviews held with key informants

This section presents information regarding Subject 4 collected during interviews held with key informants: the social worker, two of the carers and the pastor at Lebone, as well as a teacher at Shanon Intermediate School.

3.1 Social worker

Lebo's present family consists of her granny and three brothers at home. Although she is known to Lebo as her grandmother, she is not her biological grandmother. Lebo's biological grandfather is the brother of that woman's (i.e. her "grandmother's") husband. They raised Lebo's mother together with their own children as she was very young at the time of her parents' death. When Lebo's mother was older she relocated to a place of her own in Cape Town. While she was there, Lebo's father made her pregnant, and left. She returned to Bloemfontein without him, where she gave birth to Lebo. She never married. She had a boyfriend, but lived alone with her children. When she fell ill, Lebo's eldest brother had already moved to Cape Town with his wife. The "grandmother" took care of Lebo's mother during that time. The woman suspected that Lebo's mother had AIDS, but Lebo's mother never disclosed her status to her. She was only told after her death.

Lebo's eldest brother decided to send Lebo to Lebone after his mother's death, because they were afraid that she might be HIV-positive. He always collected grant money to take care of Lebo, but used the money to buy alcohol and cigarettes for himself instead. Although Lebo was tested HIV-negative, he relocated to Cape Town, and was still not prepared to look after her. The social worker kept Lebo at Lebone because she felt that it was not safe for her to live alone with her two other brothers. Although they lived on their own, they were still young and would go out at night, and leave Lebo alone at home. Both brothers are still in high school, and live off a child support grant. It was arranged that during the school holidays, she could stay with her grandmother and visit her brothers, but only during the day.

The social worker described her as a very emotionally expressive child. *"She likes crying, if she go to visit her granny, she's crying. If she comes back to Lebone, she's crying, she's that kind of child."* She perceives her as very quiet, straight forward and intelligent. She does her homework and does well at school. When she was taken up at Lebone she suffered from an eye problem. Her eyes were very red and sore. The social worker thought that it was due to the fact that they had perhaps left her to play outside for very long periods at a time. Since then, her eyes have cleared and she only has skin and tooth problems. Sometimes she would develop sores on her legs, but it would clear by itself after a week or two. Every so often her cheeks would also become swollen. The social worker planned to take her to the dentist during the school holidays.

3.2 Caregivers

Lebo is a quiet, intelligent girl who does well at school. One of the older children usually helps her with homework. Lebo enjoys helping her friends and the younger children with their homework, too. She loves playing. Her favourite game is to collect some of the children inside a steel pipe structure, which stands next to the house at Lebone. Some children would sit, and others would lie on the pieces of mat that she places on the ground. The carer does not know exactly what they are doing then, but it appears that they are "playing house," and that Lebo is in charge. Lebo's friend, Dikeledi, always enjoys playing this game.

According to the carer, Lebo would often get angry. For the whole day she would then not want to play with her friends, eat or talk to anyone, and if someone forced her to eat, she would cry and say that she did not want to eat. Her mood would clear after a day or so if she was left alone, and then she would eat, play and laugh again. The carer said that Lebo likes to spend a lot of time with the babies in the house when she is in such a mood. She would play with them and this would usually make her feel better. She usually speaks a lot to the other caregiver.

The other carer stated that the children definitely "played house" in the steel pipe structure. She would often give them pots and pans, and food to play with. Lebo often pretends to be the mother of the household. She feeds the children, sends them to school or crèche, and instructs them to go to church. They also pray together before they eat. The older children join in the game. The household does not have a husband, only a mother and children. Even the older boys, like Bophelo, are considered children. The boys are always instructed to rake the yard and to go to school. The carer said that, because of her plump build, Lebo plays

just like a pumpkin. Although she plays, she is lazy, and according to the carer, jumps just like frog. Lebo loves her grandmother very much. The carer said that she always cries when she sees her at Lebone. Lebo always shares the sweets that her grandmother gave her with the other children. The carer considers Lebo as her doctor, because when her feet are sore, Lebo always rubs them with cream. Lebo enjoys being called “Sister” (nurse) or “Doctor” by the carer. Lebo told the carer that one day she wants to wear a badge like the nurse who visits Lebone.

3.3 Pastor

Lebo stayed with various people. The circumstances were poor. There was a lot of fighting in the households and she had not been properly cared for. The pastor said that now he often looks at her when she is noisily playing and running around, and thinks “*hey!, if you know where you came from, those times. She’s better now.*” The pastor is of the opinion that the fact that her grandmother volunteered to take responsibility for her, contributed positively to Lebo’s life.

3.4 Teacher

Lebo would often become “*down and emotional,*” and cry about her mother in class, particularly when the teacher’s lesson involves a discussion on parents, or family-related matters. The other children then reported the matter to the teacher who gave her a hug, and told her that she is not alone, that they love her and that the teachers are all her parents at school. Afterwards, Lebo felt better and enjoyed class again. The teacher described Lebo as a willing, helpful, and exceptionally intelligent girl. He often asked her to help some children with homework at Lebone. Her own homework is always done and she often enthusiastically reminds the teacher of homework that must be revised. According to the teacher, Lebo does very well in English and is also competent in speaking the language. Lebo is very good in memorising poems. “*She’s number one, I don’t have any problem, even her schoolwork is perfect.*” Lebo has a best friend at school with whom she spends most of her time. This friend is from town, and is the same age as Lebo. She is not as intelligent as Lebo, but does well in school. They often help each other with schoolwork and share their pencils with each other.

4. Identified themes and categories

The identified themes and associated subcategories from the information concerning Subject 4 are presented in Table 5.7. The following table only presents this subject’s responses to the external realities listed in Table 5.7.

TABLE 5.7: Identified categories and subcategories (Subject 4)				
	External realities (stressors)	External supports	Inner strengths	Interpersonal, problem-solving skills
Communication mapping, River of life, Happy and sad.	<p>Serious illness of family member</p> <p>Loss of primary caregivers and her sister</p> <p>Death</p> <p>Violence</p> <p>Crime</p> <ul style="list-style-type: none"> • Kidnapping <p>Suicide</p> <p>Teasing</p> <p>Corporal punishment</p> <p>Poor health</p> <p>Relocation</p>	<p>Supportive relationships</p> <ul style="list-style-type: none"> • Mother (when she was alive) • Mistress Monono • Mamma Lulu • Mamma Andri • Sister • Grandmother • Three brothers • Two caregivers at Lebone • Pastor • God • Close friend (and role model) <p>Supportive environments</p> <ul style="list-style-type: none"> • School • Lebone 	<p>Faith</p> <ul style="list-style-type: none"> • Healing • Comfort • Safety <p>Morality, social values and restraint</p> <ul style="list-style-type: none"> • Against alcohol and drug abuse • Against violent behaviour (i.e. fighting, beating others) • Judgment • Values love • Against neglect • Against self destructive behaviour • Forgiveness • Values peaceful conflict resolution <p>Emotional management</p> <ul style="list-style-type: none"> • Able to recognise feelings and control undesirable feelings <p>Achievement motivation</p> <ul style="list-style-type: none"> • Motivated to do well in school <p>Optimism and positive identity</p> <ul style="list-style-type: none"> • Positive view of personal future • Happy disposition • Most people love her <p>Trust</p> <ul style="list-style-type: none"> • Caregiver in the house 	<p>Problem solving ability</p> <ul style="list-style-type: none"> • Able to find or ask for help <p>Self-efficacy and personal power</p> <ul style="list-style-type: none"> • Belief in ability to exercise control over future and threatening situations <p>Goal setting, purpose in life and commitment to learning</p> <ul style="list-style-type: none"> • Related to helping others <p>Constructive use of time</p> <ul style="list-style-type: none"> • Playing <p>Communication</p> <ul style="list-style-type: none"> • Ability to easily talk to strangers • Conflict resolution
Additional identified subcategories				
Social worker	<p>Single parent household</p> <p>Separation from siblings</p> <p>Neglect</p>	<p>Supportive Relationships</p> <ul style="list-style-type: none"> • Older child (16 years) from Lebone 	Intelligence	
Carers	<p>Separation from caregiver</p> <ul style="list-style-type: none"> • Grandmother 		Generosity	
Pastor	<p>Anti-social values</p> <ul style="list-style-type: none"> • Conflict <p>Poor care</p>			
Teachers		<p>Supportive relationships</p> <ul style="list-style-type: none"> • Teacher • A friend from town 		

TABLE 5.8: Responses to stressors or adversities (Subject 4)		
External realities (stressors)	Initial thoughts, behaviour, feelings or emotions	Present thoughts, behaviour, feelings or emotions
Serious illness of family members	Lebo felt afraid and unhappy when her mother was ill. She was afraid to tell her friends of her mother's illness because she thought that they would laugh at her . She discussed her mother's illness with her grandmother and brothers because they lived with her then.	
Death, loss of primary caregivers and her sister, and separation from caregiver (grandmother) and siblings Relocation	When Lebo heard the news of her mother's death she thought of how much her mother loved her . When she heard the news of her sister's death she cried and also thought of how much she loved her . She was in pre-school at the time, and the teacher had asked her why she was crying. She spoke to children at school and some of the staff members from Lebone about her sister's death. Lebo often cried when she saw her grandmother at Lebone. When she left Lebone to visit her grandmother for the school holidays, she cried and when she left home to return to Lebone she also cried.	Lebo says that she is at Lebone because she is an orphan. It makes her sad being without parents and she thinks of them often . Although she misses both her parents, she misses her mother the most . She has fond memories of her mother. She says that she misses her mother because her mother loved her . Lebo would often be "down and emotional" about her mother in class. The teacher would then comfort her and she would then feel better and enjoy class again . The death of her sister is something from her past that hurts her . She appeared very sad when she told the researcher this. When the researcher suggested that she depict the feeling of having lost her sister, Lebo refused . Eventually she agreed to draw a picture of her sister. Without answering she picked up a pen, drew quickly, apparently careless, frustrated and angry . She told the researcher that while she was drawing, she thought of how much she loved her sister . She recalls that she saw a photograph of her sister in an album and that they played together . She misses playing with her sister the most.
Violence		Lebo agrees that instead of fighting, one should rather deal with anger by talking to one another . She suggests that people should ask for forgiveness if they have done something wrong , and says that then everyone would be happy and feel better again . Lebo argues that Jesus Christ felt unhappy and became angry with people who fought . According to Lebo, if He were present at the fight He would tell the people to stop fighting and swearing because its a bad thing . He would only forgive them if they apologised as they were doing things that they were not supposed to . She thinks that He is strong, but would not fight back because He is a child of God . That thought makes her feel happy and safe . When she wears the necklace she thinks of Him being close to her.
Crime • Kidnapping		If Lebo ended up on the street she thought that she might be kidnapped , and said that then she would just cry . Lebo said that if someone tries to kidnap her she will phone the police .
Suicide	Lebo felt sad when she heard the story of the suicide.	Talking about the event makes Lebo feel angry . She specifically explains that she feels angry because the child is left alone . She adds that she never felt alone . She thinks that people would not feel happy if she were to kill herself and feels that it would not be right to hurt herself like that if she were lost. She then suggested that instead, she could contact someone , if she knew their numbers and there was a Telkom phone nearby. If not, she thought that she would end up on the street and someone might kidnap her . Lebo thought that it is better to talk about problems or feelings than to hurt herself because people would not want her to kill herself

External realities (stressors)	Initial thoughts, behaviour, feelings or emotions	Present thoughts, behaviour, feelings or emotions
Corporal punishment	Lebo became afraid of being beaten repeatedly so she told her mother about what had happened. Her mother wrote a letter to the teachers. That made Lebo feel happy because everyone apologised and she was not hit again . Lebo said that her river flowed down when her mother hit her with a shoe because she played with her mother's clinic card.	During the third session, Lebo told the researcher that her teacher had hit her that day. At first, she said that it really hurt , but then later confessed that it had not really hurt very much . When questioned about the incident Lebo pulled the hood of her sweater over her head . She was kneeling on the floor and started to rock back and forth . During questioning she kept on pulling the hood even further over her head .
Teasing Poor health	Sometimes her friends fought with her and teased her about the colour of her eyes. She thinks that her eyes are brown because she has problem eyes . Her eyes would often be painful and then she would feel like rubbing or scratching them . The carer said that there are days when Lebo does not feel well . She would then appear angry, not want to play, eat or talk and when someone forces her to eat she would cry and say that she does not want to eat . If she were left alone, her mood would clear after a day or so and she would play, eat and laugh again . Lebo spends a lot of time playing with the babies in the house when she is in such a mood and that usually makes her feel better . Although her friends fought with her and teased her, she enjoyed going to school .	Lebo looked sad when she told the researcher about the fighting and being teased by her friends and said that that made her river flow down .
Anti-social values • Conflict Poor care		The pastor did not give a description of her behaviour or health before she came to Lebone, but said that "she's better now." He referred to the fact that now, he would often observe her noisily playing and running around .
Being lost and other difficulties (hypothetically speaking)		If she were lost, or found herself in a difficult situation, she would phone someone if she had their numbers. Otherwise, she would cry and said that she could kill herself with a knife if there were one nearby.

Risk factors and stressors pertaining to Lebo's family and home environment include growing up in a single-parent household, neglect (by her two brothers), conflict, poor care, harsh corporal punishment, the serious illness of a family member (i.e. her mother), death, and loss of primary caregivers and of her sister. Periodically, Lebo also suffers from poor health. At school, she is often involved in fights and teased by the other children. Adversities and stressors concerning the community are violence, crime (i.e. kidnapping), death and suicide.

Before she fell ill, Lebo's mother was the primary source of support in her life. During Lebo's mother's illness, her "grandmother" was a protective factor in her life. Lebo had a loving relationship with her sister and she enjoyed playing with her. Lebo perceives her current primary support network as consisting of two caregivers from Lebone and her eldest brother. She has established a trusting relationship with one of the caregivers in particular. Other supportive adult relationships are those with the teacher at Lebone, Mamma Lulu, Mamma Andri and the pastor from Lebone. Lebo also has supportive relationships with the children at Lebone. She has made a close friend and enjoys playing with the babies in the house when she is not feeling well. Outside Lebone, Lebo receives support from her grandmother and three brothers. The researcher gathers that the relationship with her two younger brothers is supportive in that it is a loving relationship. Her relationship with the other brother is not only a loving relationship, but he has also supported her academically and she looks

up to him as he does not smoke or abuse alcohol. However, according to the social worker, he smokes and abuses alcohol. Nevertheless, Lebo's viewpoint reflects her own thoughts on the matter, or in other words, her own social and moral values. At school, Lebo has formed a close relationship with a girl from town, and her teacher has also been very understanding and supportive concerning her grief for her parents. During the interviews two domains of influence, namely the school and Lebone were highlighted.

The story which Lebo heard and told during one of the interviews reflects her own inner strengths concerning morality, social values and restraint. She is against violent and self-destructive behaviour, and neglect. She values love, peaceful conflict resolution and forgiveness, and expresses clear judgement about these and other issues. Lebo believes in God and has found healing, comfort and safety in faith. She uses play and resilience strengths such as communication, intelligence, emotional management and self-efficacy to solve problems. Play also indicates constructive use of time. Self-efficacy also links with achievement motivation, optimism and positive identity, purpose in life, commitment to learning and goal-setting, in terms of her future aspirations. Throughout the interviews, particularly those with key informants, intelligence, and a strong purpose found in service or helping others were evident. Her belief that most people like her also reflects her ability to recognise and value positive feelings towards her.

SUBJECT 5 - Poelo

1. Biographic information

Poelo was born on 20 June 1993, and is now 13 years old, the eldest of all the participants in the research. She lost her mother to AIDS at the beginning of her school career, and was admitted to Lebone at the age of 10 when her father fell ill. She used to visit her father at a care facility in Bloemfontein during the school holidays, until he passed away on 19 April 2005, due to illness resulting from AIDS. Now she visits her uncle and aunt at Mafora location during school holidays. She is an only child whose home language is Sesotho. She also speaks English as a second language.

2. Idiographic data

2.1 Communication mapping

Poelo depicts herself as happy girl, playing netball. She plays netball in one of the school's teams and says that she enjoys it very much. She told a story of the girl she drew: *"She's wearing a school uniform and goes to Maryvale. When she's at school she plays with friends. When the bell rings, they go in class and start writing, writing EMS, Economics and Math Science [i.e. Mathematical science]. Then after school they sweep the classroom. After sweeping the school out, then they ride the combi and come to Lebone and play karate. After karate its late in the evening and they have supper. Then we pray and then after praying we sleep, in the morning we wake up and wash again, and go back to school again."*

Poelo drew the faces of nine friends and the two caregivers at Lebone to represent the most important people in her life. She wrote the names and ages of her friends, which varied between seven and twelve, next to each picture. Of all the people she depicted, mamma Teboho is the most important. She likes her because *"in the evening she baths us and gives us sweets."* Poelo describes her as a friendly lady who loves them. Rakgadi, the other caregiver, *"looks after us, cooks for us and gives us food."* She says that she trusts her friend Puleng the most because she is her *"important, best friend."* She says *"if I can go away from Lebone, or maybe Puleng goes away from Lebone, I'll always remember how nice we played together."* Seithati is also a good friend. *"I also play at school with her. We don't fight together,"* and *"also Dithuso, if I'm not at Lebone, I miss her."* They skip and play *"gati"* together.

Poelo loves playing, writing, colouring in, and dancing to cultural music. If ever she found herself in a difficult situation or got lost she would *"phone to be collected,"* and if there was no phone, she would *"go, walk and ask for help."* She says that she does not find it easy to talk to strangers, but in such an instance, she would try and ask for help. If she had family living nearby she would go to them. If not, she would keep on walking

until she saw a taxi. She would ask for help and ask to be dropped off at Thaba Nchu. She believes that most people love her, and she knows no one who dislikes her. She says that she is very good at Arts and Culture and Life orientation at school, and enjoys those subjects. She wants to become a nurse “*because when my father was sick, I used to stay at hospice with him where there were nurses.*” The nurses often asked her what she wanted to become, to which she used to reply that she wants to follow the same profession as they do. She says that she felt sad and scared when her father was ill, because she thought that he was going to die soon. At the time of his death she was at Lebone. She says that when she is a nurse one day, she wants to care for sick people and for people who have been involved in car accidents. She recalls that she saw an accident in the township, in Freedom Square. “*The car came speeding up and then it went straight to the electric pole and it collapsed.*” Three people were injured and she recalls that at the time: “*I had hope and thought the nurses would help those people.*” She ran back home and told the people in the house about what had happened. They all went to look. She became scared and worried, because “*we were still living, staying with my father at Freedom Square, and then that day, I thought maybe it was my father.*” When she realised that he was not in that taxi “*I became happy.*”

Poelo was present the day before her father passed away. “*I went to Tsepo House. When I got to Tsepo House, I found that pappa was now very, very sick. I stand next to him, and then I started crying.*” The translator explained that she went with her that day. Poelo entered the room and stood at her father’s bed. “*I came nearer, then I told him that I loved him.*” The translator explained that “*she did to him as the Romans do, may the grace of our Lord, Jesus Christ,*” and made a gesture with her hand from her head to her heart, and from side to side across her chest. Poelo says: “*and that was the last time I saw him.*” She often thinks about that day. She misses the way he used to love her. “*He used to go to town, and then he said I must choose whatever clothes I like. And then I would choose.*” The translator was sitting next to Poelo and the researcher asked her to put her arm around Poelo. Poelo cried. “*Then again we went to town another day, we went to the restaurant and have some meal there, and then we went together. After eating we went back to Tsepo House. And then, the following day, we went visiting where we used to stay at Mafora. And then, when we got there, we found that the house had been burgled, everything we had inside had been stolen. And then my father went looking for them, and then he found them in the neighbourhood, and then he found that somebody had sold our belongings to other people.*” She also recalls that when he went to hospice for treatment, “*he was sick that time and he told me that when he dies everything that he has is gonna be mine, and then dad said I mustn’t be sad because he is sick and the sickness that he’s got hasn’t got any cure.*” Poelo drew a picture of her father. The researcher drew a heart around the picture of her father and Poelo agreed that he would always be close to her, in her heart. Throughout this session Poelo presented herself as a soft-spoken, polite, sensitive and well-mannered girl.

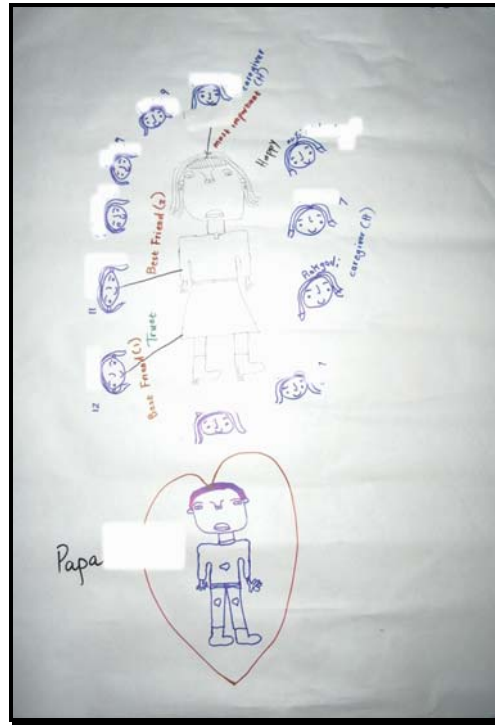

Figure 5.13: Poelo. *Communication mapping* (2006). Pen on paper, 58 x 81cm

2.2 River of life

At the time of Poelo's birth her family lived in a township called Freedom Square. She recalls that her mother held a birthday party for her when she turned three. "*It was nice and fun and my mother asked somebody to come and take photos, me and my other sister.*" She kept the photograph, and often thinks of her mother "*when she was still alive and organising parties for me,*" when she looks at the photograph. Poelo says that her mother looked just like her sister. She remembers that her mother made nice food and lots of friends played with at her party. They played a game called "*giants.*" The translator explained: "*There are few chosen to be giants, others are children, and one is the mother. So, the giants stand on the side, the mother at that end, the children at that end. So, the mother shouts, 'my children, my children,' then they respond, 'ma.' 'Come back home,' then they say 'we are afraid,' 'Afraid of what?' 'Of giants.' 'What are they wearing?' 'Gum boots.' 'And on their heads?' 'Boxes.' 'Run, come home.' So when they run home, the giants on the side grabs them, others manage to escape to the mother.*" Her favourite toy was a white doll with long hair and "*smart*" pink clothes. She says that she played with her doll, especially at times when she felt lonely. She drew a picture of her doll. She was living with her mother, sister and father at that time. Poelo remembers the good relationship she had with her father, and that it was fun in the house. Her father worked at a hotel, and she always looked forward to visiting him at work with her mother and sister. They always had a meal there. She has fond memories of shopping for dolls with her mother. Her river flowed up.

Poelo's mother relocated to her uncle's house when she fell ill. Towards the end of Grade 1 at school, her mother passed away. Poelo was there that day. Her river flowed down. She slept beside her mother on the bed. Her mother faced the other way and Poelo did not notice that she had died. When Poelo tried to wake her, she would not wake. Her sister came, but was unable to wake her. Her sister cried and told Poelo that their mother had passed away. The people in the house then told her sister not to cry because they felt that she would upset Poelo. Poelo felt sad and thought of the time her mother had held a party for her. The next day she sat outside the house for the entire day and cried. Her aunt told her not to cry "*because* [she said that] *her mother just went to town.*" Poelo did not believe her.

After her mother's death her father sold the house, and Poelo and her father relocated to another township. When her father fell ill, her aunt came to live with them to take care of him. A MUCPP (Mangaung University Community Partnership Programme) community worker then took Poelo to Lebone. Poelo was sad to leave her father, but happy to go to Lebone. She recalls that she was introduced to the other children at Lebone on the first day. Her river flowed up again. Her father passed away when she was twelve years old. Again she remembers the day when she was told that he had wanted to see her. She was fetched from school and went to visit him. Poelo found him "*terribly sick.*" She called his name but he did not respond. After the third time, he said "*huh,*" but did not spoken further. She told him that she loves him. She cried and thought of the times he took her to town to buy clothes. That was the last time she saw or spoke to him. Poelo heard the news of her father's death the next day after school. She says that she feels sad thinking about that day, because she misses him. When the researcher asked her what it was like for her living without her parents, she said: "*I still feel fine, because all the people that we live with here at Lebone are our mmmas and our pappas.*" She agrees that she has a lot of people around her at Lebone who love and care for her. This made living without parents easier for her.

Poelo envisions a happy future. She is going to finish school, become a nurse, and work at National Hospital in Bloemfontein. Poelo will live with her grandmother until the age of thirty-seven, save money, and then buy a "*smart*" two-bedroomed house of her own. She wants a red house, painted pink inside with a kitchen plus fridges, a lounge, and two bathrooms. She will live there with her cousin, and drive a blue Toyota car. Poelo does not foresee her river flowing down in future, but if that were to happen, she says that her friends will help her through the hardships. About future relationships, she says that she does not want to have a boyfriend in school. She does not like boys because they are naughty. She says "*they do funny stuff to girls or say funny things to girls.*" She is unable to elaborate on their actions, but says that she saw them "*being naughty like that*" at school and around the location. She then says that boys around the location had whistled and called her when she visited home during the school holidays. She "*just looked at them ugly.*" She does not want to have children or get married. She says that she is afraid that if she has children, they will become "*tsotsis.*" She reasons that "*other kids start stealing at their homes and then they end up staying outside, like tsotsis on the streets. Others they don't want to be punished or disciplined in the house so they end up going out on the streets and end up smoking dagga.*" She believes that children who smoke dagga are "*gonna end up being real tsotsis and killing people.*" She says that she does not know of any children at school who use drugs. Throughout the session Poelo seemed a little tense. Therefore, at times, the researcher avoided extensive questioning on hurtful events from the past.

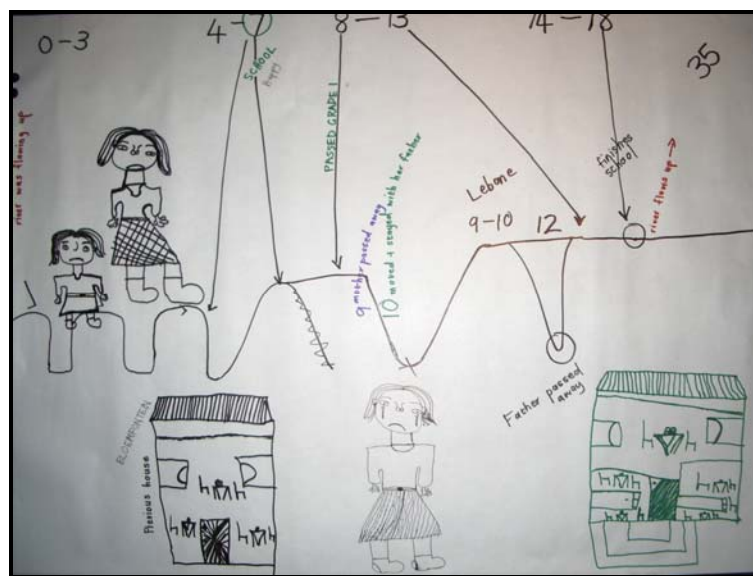

Figure 5.14: Poelo. *River of life* (2006). Pen on paper, 58 x 81cm

2.3 Happy and sad

Poelo was asked to close her eyes, relax, and listen for sounds that she could hear. She pinched her eyes shut and carefully listened. She heard the sounds of birds, cars, dogs, people talking, and the gas heater behind her in the room. She then thought of the death of her father. That hurt her the most in her life. She says that she misses him a lot. She thinks of him every day. She remembers when he spoke to Gloria to ask if he could take her to town to buy clothes for school. She misses him buying her things and recalls that they always visited others.

Poelo says that she would like to go home during the school holidays. Since her father passed away, she usually visits her uncle and aunt during that time, and enjoys staying with them. She opened her eyes and the researcher asked her to draw a picture of how she felt. Poelo depicted, “*if the heart’s got pain*.” She thinks of the people at Lebone and the care she receives and that makes her heart feel better. She usually speaks to someone, mostly mamma Emelia, when she is sad. She says that mamma Emelia reminds her of how much her father loved her. Playing with friends alleviates her sadness. She agrees that she has lots of friends and people around her who care for her, and would help her through difficult times. Although she also misses her mother, she misses her father even more. The researcher reflected on the meaning of the heart Poelo drew around the drawing of her father during the first session. Again, the researcher drew a heart and asked Poelo to write the names of the people she misses the most and wants to keep close to her, inside the heart. She wrote the names of her parents and mamma Teboho in the heart. She says that the name of mamma Teboho is included “*because she loves me, and cares for me carefully*.” She agrees that those three people are very special to her and will always remain in her heart. No one could ever take the good memories she

kept of them away from her. Thoughts of those memories will help her through sad times. She says that she believes in God. She believes that God thinks that she is a strong girl, and even though it is difficult for her to live without her father, she will grow up to make Him proud. She believes that when she goes to heaven one day, she will see her father again.

She closed her eyes again. Poelo says that having friends makes her happy, and having her own house in town one day will make her happy. She drew a picture of the house, and mentioned that it would make her happy if the researcher made a card for her. Poelo's "good bye" picture was of her saying that she loved the researcher, and said that the researcher could remember her by the drawings she had made. She gave the researcher a hug and went to play outside.



Figure 5.15: Poelo. *Happy and sad* (2006). Pen on paper, 58 x 81cm

3. Interviews held with key informants

This section relates to the information gathered during the interviews with the social worker, two of the carers and the pastor at Lebone, and a teacher at Shanon Intermediate School, regarding Subject 5.

3.1 Social worker

Poelo lived with her older sister and parents in Freedom Square. After her mother's death, her father remarried and moved to another township with Poelo. His eldest daughter then went to live with her uncle and aunt in Thaba Nchu. His new wife also passed away. After her death, he fell ill. A home-based carer visited the house now and then. She helped with the washing, Poelo's father's medication, and fetched water which was obtainable some distance from the house. Poelo also visited her at her house at times. The social worker suspected that this carer is the aunt to whom Poelo refers. A MUCPP community worker also visited Poelo's father at home during that time. The community worker learnt that Poelo used to go to people in the neighbourhood to ask for food, and was worried that she might get raped. She contacted the social worker at Lebone and she showed her where they lived. *"It was a small shack, it was that man, he was very ill with dog underneath the bed, and then Poelo wasn't there. Under the bed was a bucket with a lot of things there, he was relieving himself there in the bucket, and there in the house was just tablets and a packet of Piloni. There was nothing in the house, no food there. On top of him was only coat. All the blankets were wet, all the blankets got stools on it, there by the corner, so he was only using his coat, to sleep, and then here on the bed, it was only mattress. He was sleeping on top of the mattress, no sheet, nothing. Everything was dirty, there by the corner. Poelo, they were sleeping in one bed until one of the home-based carers came to take her."* Poelo did not attend school at that time, and her father was unable to tell them where she was. He wanted them to take Poelo away that same day, because he was dying. He said that his daughter was suffering, because he had been ill, and that there had been no one to take care of them. The social worker then arranged for him to be taken to Tsepo House. Poelo was accommodated at Lebone, and her father survived two years at the hospice. During the two years, Poelo visited him at the hospice until he passed away. Her uncle made all the funeral arrangements, and Poelo attended the funeral with two of the staff members from Lebone. None of the family members comforted her at the funeral, because her father did not have a good relationship with his family while he was alive.

Six months after her father's death, his brother's wife, that is Poelo's aunt, visited Lebone. She wanted to take care of Poelo during the school holidays. The social worker agreed, because she thought that Poelo needed a family. Poelo still visits them regularly. They live in a big house on a plot with their grandchildren and Poelo's older sister. The aunt told the social worker that Poelo's father did not want her help when he was ill, and said that he would take care of Poelo.

The social worker described Poelo as a quiet girl who always obeys orders and has no behaviour problems. She said that they treat her and her two friends like *"big sisters to the other children, because they are the oldest."*

3.2 Caregivers

Poelo often speaks to the carer. The previous evening, when they were watching television she asked the carer if her mother had loved her and whether she had made any mistakes in her life. The carer told her that

she had made some mistakes and had given her an example. Poelo agreed that it was wrong. The carer told Poelo that, at the time, her mother was ill and needed her care. Therefore, the carer's mother was very unhappy with the mistake she had made, since she was no longer able to take care of her mother as before. Poelo said that she also cared for her father, and that was why he had loved her. She proudly said that unlike the carer, she had not made such a mistake. Poelo asked her whether she loved her children and would teach them to respect adults like her father had taught her. The carer agreed, and Poelo told her that she perceived her as a good mother. Poelo told her that she and two of her friends planned to take care of her when she was old. The carer said that Poelo enjoys making jokes with her. She would often poke fun at her grey hair, hit her playfully and run, or swing her around and dance with her. At some point, she would then decide that both of them are tired and would offer to make the carer a cup of tea. The carer said that Poelo does well in school and would go straight to Gloria for help if she struggled with homework. She enjoys sports. She jogs in the mornings, plays netball at school, and occasionally plays soccer with the boys over the weekends.

According to the other carer, Poelo enjoys helping with washing the dishes and cleaning the house. She is a good child and talks a lot to her about her family. She told the carer that her father always bought her clothes and things she needed. She considers her uncle as her father now, and says that he takes good care of her. The carer said that Poelo does not enjoy being in the house that much. She always wants to play outside. She loves "playing house."

3.3 Pastor

According to the pastor, Poelo is no longer the girl he knew when she first came to Lebone. He added that, now that she is maturing, she has become very reserved. He recalled the day they fetched her from home to be taken to Lebone. He waited in the car, and was touched by how responsible and caring she was for a child of her age. She fed her father, washed him, and tried to do anything she could for him. It was very difficult for Poelo, but she handled it boldly, maturely. The pastor thinks that she is "*going to be a real mother.*"

3.4 Teacher

Poelo listens in class. She is very disciplined, well-mannered, and does well in school. Her best friend is not from Lebone. The teacher separated them in class because they were both dedicated to their work, and she used them to help others who struggled. They have, however, remained friends.

4. Identified themes and categories

Table 5.9 presents the identified themes and associated subcategories from the information concerning Subject 1. Subsequently, without interpretation or discussion, Table 5.10 organises this subject's responses to the external realities listed in Table 5.9 according to the child's initial and present thoughts, behaviours and feelings or emotions.

TABLE 5.9: Identified categories and subcategories (Subject 5)				
	External realities (stressors)	External supports	Inner strengths	Interpersonal, problem-solving skills
Communication mapping, River of life, Happy and sad.	Serious illness of family members Loss of primary caregivers Death Car accident Crime <ul style="list-style-type: none"> • Theft Negative gender-based relations Relocation	Supportive relationships <ul style="list-style-type: none"> • Parents (when they were still alive) • Two close friends • Seven good friends • Two caregivers at Lebone • God • Extended family (uncle and aunt) • Hospice nurses Supportive environments <ul style="list-style-type: none"> • School • Lebone • Hospice 	Faith <ul style="list-style-type: none"> • Healing • Comfort • Purpose Morality, social values and resistance skills <ul style="list-style-type: none"> • Against violent behaviour (i.e. fighting) • Against drug abuse • Caring for others • Values love • Fair play • Well-mannered • Avoids early involvement in serious relationships with the opposite sex • Can resist negative peer pressure and dangerous situations Emotional management <ul style="list-style-type: none"> • Able to recognise feelings and control undesirable feelings Achievement motivation <ul style="list-style-type: none"> • Motivated to do well in school Optimism and positive identity <ul style="list-style-type: none"> • Positive view of personal future • Happy disposition • Most people love her • Photographs (positive childhood memories) Trust <ul style="list-style-type: none"> • Close friend 	Problem solving ability <ul style="list-style-type: none"> • Able to find or ask for help Self-efficacy and personal power <ul style="list-style-type: none"> • Belief in ability to exercise control over future and threatening situations Goal setting, purpose in life and commitment to learning <ul style="list-style-type: none"> • Related to helping others Constructive use of time <ul style="list-style-type: none"> • Playing • Sports (i.e. Karate, netball) • Working • Creative activities (drawing, writing, music and dancing) Hope Communication
Additional identified subcategories				
Social worker	Separation from sibling Loss of caregiver <ul style="list-style-type: none"> • Stepmother Restricted school attendance Hazardous neighbourhood	Supportive relationships <ul style="list-style-type: none"> • Home-based carer Supportive environments <ul style="list-style-type: none"> • Home of extended family (i.e. uncle and aunt) 	Obedience	Communication

Additional identified subcategories				
	External realities (stressors)	External supports	Inner strengths	Interpersonal, problem-solving skills
Social worker	Poor care Poverty Poor family relations and rejection Unemployment			
Carers		Humour • Making jokes		
Pastor			Responsible	
Teacher			Disciplined Dedicated (to do her work)	

TABLE 5.10: Responses to stressors or adversities (Subject 5)

External realities (stressors)	Initial thoughts, behaviour, feelings or emotions	Present thoughts, behaviour, feelings or emotions
<p>Serious illness of family members, death, loss of primary caregivers, separation from family members</p> <p>Hazardous neighbourhood</p> <p>Restricted school attendance</p>	<p>Having laid next to her mother, Poelo had not noticed that she had died. When Poelo had tried to wake her, she would not wake. Poelo's sister had told Poelo that their mother had passed away. Poelo felt sad and thought of when her mother had held a party for her. The next day Poelo sat outside the house for the entire day and cried. Poelo had not believed her aunt when she told her not to cry because her mother had just gone to town. Poelo played with her doll when she felt lonely. When Poelo's father had been ill, but had still been at home Poelo had gone to people in the neighbourhood to ask for food. She had washed him, fed him, and had tried to do anything she could for him. According to the pastor she had been very caring and responsible for a child of her age. It had been very difficult for her but she had handled the situation boldly and maturely. She had felt sad and scared when her father had been ill, because she thought that he was going to die soon. Shortly before his death, Poelo and the educator from Lebone had visited Poelo's father. Poelo had stood next to her father's bed, had then moved closer and had told him that she loved him. She made a gesture with her hand from her head to her heart, and from side to side across her chest, and said: "may the grace of our Lord, Jesus Christ..." She had cried and had thought of the times he had taken her to town to buy clothes.</p>	<p>She said that if she were a nurse one day, she wanted to care for people who were ill. She often thought about the day her father had passed away. His death was the one thing that had hurt her most in life. She said that she felt sad thinking about that day, because she missed him. She missed the way he used to love her. Poelo thought that her father had loved her because she had taken care of him when he was ill. During the first session Poelo shared the happy memories she had of him and cried. She agreed that he would always be close to her. She usually spoke to someone, mostly mamma Emelia, when she was sad. Mamma Emelia, reminded her of how much her father had loved her. Playing with friends had made her sadness subside. She considered the people from Lebone as mothers and fathers in her life. She agreed that there were a lot of friends and people around her at Lebone that loved and cared for her, and that that made living without parents easier for her. She also believed that they would help her through difficult times. Poelo believed that no one could ever take away the good memories she kept of her parents and those close to her, away from her. Poelo believed that thinking about those memories would also help her through sad times. Poelo believed in God. She believed that God thought that she was a strong girl, and even though it was difficult for her living without her father, that she would grow up to make Him proud. She believed that when she went to heaven one day, she would see her father again. Poelo enjoyed visiting her uncle and aunt during the school holidays. She considered her uncle as her father.</p>
Relocation	Poelo had been sad to leave her father, but happy to go to Lebone.	According to the social worker Poelo had no behaviour problems, and as maintained by the pastor, Poelo had changed since she had come to Lebone. Now that she was maturing she had become very reserved.

External realities (stressors)	Initial thoughts, behaviour, feelings or emotions	Present thoughts, behaviour, feelings or emotions
Car accident	When Poelo had seen the accident she had had hope for the people who had been injured, because she had thought that there were nurses that would help them . She had also become scared and worried , because she had thought that her father might have been in the taxi , so she had run back home , and had told the people in the house about what had happened . They had all gone to look . She had been happy when she had realised that he had not been in that taxi.	She said that if she were a nurse one day, she wanted to care for people who had been in car accidents .
Negative gender based relations	She had observed boys " <i>being naughty</i> " at school and around the location. When the boys from the location had whistled and had called Poelo and her friend, Poelo " <i>just looked at them ugly</i> ."	Poelo did not like boys because they were naughty . She said that boys did and said "funny stuff" to girls and did not want to get married .
Being lost and other difficulties (hypothetically speaking)		If she were lost, or found herself in a difficult situation, she would phone someone if there was a phone nearby. Alternatively, she would walk and ask for help . She said that if there were family living nearby, she would go to them . If not, she would keep on walking until she saw a taxi . She would ask for help and ask to be dropped of at Thaba Nchu .

Poelo's family and home environment is characterised by risk factors and stressors such as poverty, unemployment, poor family relations, serious illness, death and loss of family members, separation from her sister, and poor care. Adversities within her community include theft and negative gender-based relations. Poelo also witnessed a serious motor vehicle accident which may have involved her father. Her school attendance was restricted due to her father's illness.

Poelo engages in supportive and trusting relationships that counteract these risk factors and stressors. In turn, these relationships also reveal her inner strengths and interpersonal and problem-solving skills that compare with those of resilient children. Supportive relationships include those with her parents, a home-based carer, two close friends and seven good friends from Lebone, two caregivers from Lebone, extended family (i.e. her aunt and uncle), and God. From these relationships, her faith, moral and social values, and purpose in life related to helping and caring for others is particularly evident. She finds healing and comfort in faith, and besides caring for others, she exhibits social values and morality given that she is well-mannered, is against violent behaviour and drug abuse, and values love. She exhibits resistance skills as she resists negative peer pressure and associated dangerous situations, as well as early involvement in serious relationships with the opposite sex. Her positive view of her future, happy disposition, positive childhood memories, and belief that most people love her, indicate inner strengths such as optimism and positive identity. Her future projections are also linked strongly with her commitment to learning, self-efficacy and sense of personal power. Constructive use of time is indicated in activities such as playing, doing sports, and working, as well as creative or expressive activities such as drawing, writing, and dancing to cultural music. Poelo displays hope, and the ability to recognise feelings and control undesirable feelings. Domains of influence include the school, hospice, Lebone and her uncle and aunt's home.

SUBJECT 6 - Kagiso

1. Biographic information

Kagiso, now 10 years old, was born on 25 September, 1995. He lost both his parents to AIDS and has been at Lebone since 20 July, 2005. He has a 6 year-old sister, and two brothers, both a year old, who are also at Lebone. He is currently in Grade 3. Sesotho is his first language and he speaks English as a second language.

2. Idiographic data

2.1 Communication mapping

The researcher met Kagiso outside the room and explained what was expected of him. He appeared willing, friendly, but reserved. They entered the room, and he took a seat at the table.

Although the translator explained that he is expected to draw a picture of himself, he started by drawing a car. She then reminded him of the task, and he drew a picture of himself walking. He said that he is happy in the picture, and that it would make him sad if somebody fought with him. At first, when the researcher asked him what he had done previously that made him sad, he answered that he did not know. Then he said that he went to play with friends. He appeared unnerved, and the researcher reassured him that there was nothing to be scared of. He drew the faces of three friends to represent the people who mean the most to him. The four of them never fought. He trusts Bophelo the most, and said that he is also the strongest of all the friends. Kagiso said that Tsepo is his best friend, because he always plays with him. He also thought that of all his friends, Tsepo loves him the most. Kagiso said that when he gets angry he cries alone. He wishes that Bophelo and Tsepo would comfort him when that happens.

The best thing that ever happened to him was when they played football at school and won. That made him very happy. The worst thing that happened was when his father was admitted to hospital. His father then passed away. At the time he was afraid, and wondered who was going to take care of him. After his father's death he was admitted to Lebone.

Kagiso said that he is very good at playing football, and is committed to school as he wants to become a police officer. He enjoys school, and is happy at Lebone. Intermittently, at the beginning of the session, Kagiso tensely smiled. Throughout the session, he sat with his elbows on the table and his hands folded, nervously wringing them, in front of his chest. He looked sad and tearful when the researcher asked him

about the worst thing that happened in his life. He seemed to almost freeze at times, his body stiffened and he stared blankly ahead. Touch seemingly made him anxious.

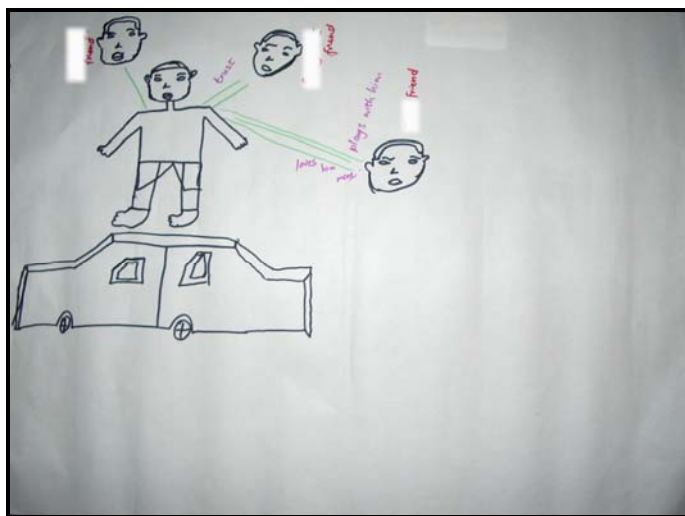

Figure 5.16: Kagiso. *Communication mapping* (2006). Pen on paper, 58 x 81cm

2.2 River of life

From birth until the age of three, Kagiso says that his river flowed up because he was living with his father. He had a black tricycle at the time, and his father bought him police cars for his birthday. Kagiso drew a picture of his father to represent that time in his life.

Kagiso started school at the age of six. Although he struggled at first, he eventually made three friends to play with at school. He says that they made him laugh. School was good, because he could write, and his river still flowed up because “*I was loved at home.*” He drew a picture of both parents. He says that they loved each other, because they were happy and never fought. That also made Kagiso happy. Their house was made of large grey bricks. It made him happy that it was a strong house. The wind did not blow through the house, and the roof did not leak when it rained. Kagiso enjoyed his little sister’s fourth birthday. There was a pink cake and, for a present, his parents bought her five dolls. Only the four of them lived in the house. Although Kagiso still remembers his mother, it makes him unhappy to think of her. When the researcher asked him to elaborate on the thoughts he had, he seemed to freeze again, and eventually said that he does not think of anything. He says that he does not feel fine when he thinks of his father. He feels like crying, and says that he never cries about his father. Kagiso says that people look at him when he cries. He misses his father very much.

Between the ages of seven and nine, Kagiso's river flowed down again. He says that his heart was sore because his mother had left him and his father had passed away. He refused to make a drawing of what he could remember of that time, but then agreed to draw a picture of him feeling sad. His aunt, whom he still occasionally sees, brought him to Lebone. Staying at Lebone has made his river flow up again. He says that the adults at Lebone love them. He mentions the names of Ntate Snyman, mamma Avril, mamma Lulu, mamma Teboho, and Mistress. What he likes and notices about them is that Ntate Snyman likes giving them new clothes, mamma Avril buys them shoes, and mamma Lulu buys birthday presents. Mamma Teboho gives them anything they want, like fruit, and Mistress gives them toys. He drew a picture of these people. While he was drawing he said that he did not think of anything. The researcher then asked him about his aunt. He said that he had been to her house before. It had been a happy house. She had two children with whom he enjoyed playing. Kagiso says that they make him laugh. He mentions the names of the six friends he has at Lebone. They enjoy playing soccer together. Kagiso then seemed a little more relaxed and the researcher asked him about his mother. He says that she was a pretty lady, had braided hair, and wore a "*doek*" around her head. The researcher asked him what he thought the best thing about Lebone was, but he did not respond. She then told him to think about it, while he continued with his drawing. He wrote the name of each person next to their picture, and then remembered the names of his parents. Kagiso asked if the translator would write the names down for him, and she added their names to the picture.

Kagiso says that his river would flow up between the ages of eleven and fifteen. When the researcher asked him what would make his river flow up, he did not answer, and seemed unnerved. She reassured him, and tried to rephrase the question and asked other related questions. Still, he did not answer. Then she asked him whether he would like to stay at Lebone. He replied that he would. The researcher asked him about his friends at Lebone. He was going to have his friends with him when he was older, and was only going to have a girlfriend when he is older than twenty years. He wants to become a policeman at the age of twenty-five, because they are good and catch thieves. He says that he is going to do the same one day. He drew a picture of his girlfriend whom he will fetch from Pieter Swartz, a location nearby, when he is twenty-six years old. Her name is Naledi, and he met her when he visited his aunt. He says that he loves her.

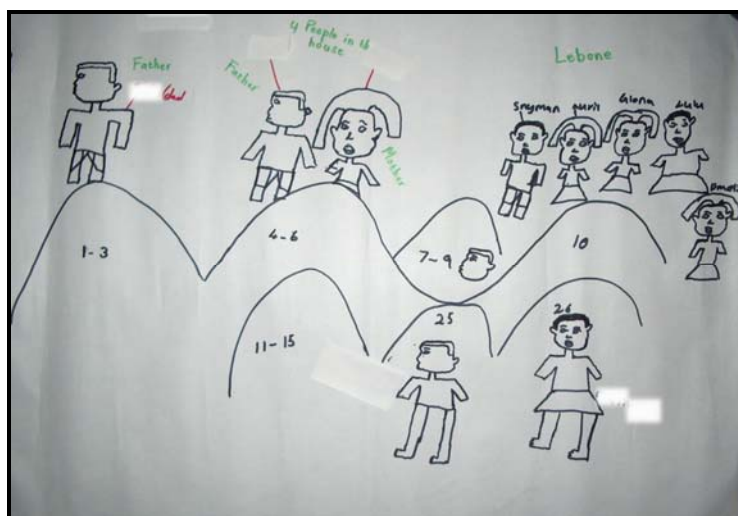

Figure 5.17: Kagiso. *River of life* (2006). Pen on paper, 58 x 81cm

2.3 Happy and sad

The researcher asked Kagiso to reflect on the saddest thing that happened in his life. He seemed to freeze and did not answer. The researcher asked him about his parents.

Both his parents had fallen ill. His mother relocated to Bloemfontein where she was cared for by a relative and Kagiso stayed in Thaba Nchu with his father. His father passed away when Kagiso was in Grade 2. When his mother returned to Thaba Nchu, she found that her husband had passed away and was taken to the mortuary. Kagiso was in Grade 2 at the time. He says that when his father passed away, his mother was in hospital. Approximately three months after the death of his father, Kagiso's mother fell very ill again, and moved back to Bloemfontein where she passed away. Kagiso was then in Grade 3. He had not been with her at the time of her death, but heard the news from the relative. He cried and was sad the day he heard of her death.

Kagiso does not worry about the future. When the researcher asked him what he is very good at, he said cooking "*pap and vleis*." Kagiso seemed unsettled. The researcher asked him whether he was alright, and he did not reply. She asked him whether he was tired, and he shook his head to indicate that he was not tired. She then continued questioning him, and he said that, although he finds it hard to talk to strangers, he would ask people the way home if he got lost.

Finally the researcher asked him to draw a picture of his mother. For him, the favourite thing he remembers about her is her long hair. She taught him how to write. The researcher drew a heart around the picture of his mother and explained that his mother would always be in his heart. He was reluctant to draw a "happy

picture” of him as a policeman one day. The researcher asked him how he felt, and he replied that he was fine. Eventually, after some encouragement, he started to draw.

On the day this session was held, Kagiso did not seem well. He did not smile at all and seemed very emotional throughout the session, struggling to answer some of the questions. Despite this, he said that if the researcher came again one day, he would be happy to draw again.



Figure 5.18: Kagiso. *Happy and sad* (2006). Pen on paper, 58 x 81cm

3. Interviews held with key informants

Information concerning Subject 6 that was gathered during the interviews held with the social worker, two of the carers and the pastor at Lebone, and a teacher at Shanon Intermediate School is presented in this section.

3.1 Social worker

When Kagiso’s mother fell ill, Kagiso dropped out of school and took care of her for approximately five months. Then, one of Kagiso’s cousins fetched his mother and took her to hospital where she gave birth to twins. According to Kagiso, this cousin stayed in a hotel. She was the last born of his mother’s sister. Kagiso and his younger sister then moved to live with her in Pieter Swartz, a township. In hospital, they learned that Kagiso’s mother was HIV-positive, and that she was referred to Tsepo house. Kagiso’s cousin then told the social worker at the hospital that she was unable to take care of the children as she worked in a restaurant and barely had time for her own children. A month after their birth, the twins were taken to Lebone. The social

worker from Lebone also collected the other two children from the cousin's house. Three days after all the children had been accommodated at Lebone, their mother passed away. Their father was a policeman, and had died of AIDS before her. The social worker had no information of Kagiso's grandparents because they lived in Thaba Nchu. After being accommodated at Lebone, Kagiso and his sister visited their cousin during school holidays, but the social worker stopped their visits, because they were not properly cared for. Their cousin had many extended family members living with her and she left the children with them when she worked at the restaurant during the day. The children complained that they had no food and were not bathed. The children were often not returned to Lebone on time, and were often injured or ill. On one occasion, she left the children with people who lived on a plot where they were not looked after. She did not return to collect them either. She returned them only when the social worker contacted her.

According to the social worker, his teachers say that Kagiso is a slow learner. She describes him and his sister as "*fine, they are just like the normal children.*" She suspects that Kagiso's sister is HIV-positive, but she has not yet been tested. Before they turned one and a half years, the twins were tested negative, but have shown symptoms of HIV infection since then. The social worker wants them to be retested. A week prior to the interview, Kagiso started having nightmares and wet his bed every night. The social worker said that otherwise "*everyone is a friend of him at Lebone.*" He has a good relationship with his sister, and quite often, after school, he would lie down on the carpet and look at the twins. When the social worker asked him who they were, he answered that he knew that they were his brothers. He loves them very much. He usually speaks about problems, especially to the caregivers at Lebone. "*He doesn't even wait a minute.*"

3.2 Caregivers

The caregiver asked Kagiso about the nightmares he was having, but he said: "*I don't know, I don't know.*" She was not sure why he reacted that way. He usually always talks to her and asks her for things he wants or needs. She recalls that he once saw a picture of a pair of shoes in a newspaper, and asked her to help him to buy them, and when he is hungry he tells her of his food preferences. He also tells her about subjects with which he struggles at school, and that his teacher hit him for not understanding the work. She then tried to patiently answer a few questions and explain the work to him. She perceives Kagiso as a very quiet boy who does not laugh a lot with the other children. He is often withdrawn and seems upset. He would then say to the other children that he feels tired and does not want to play or talk. His best friend is Bophelo.

She knew of an aunt he visited a couple of times in the township. She is still young. She works, and stays with other people in a small house. Kagiso has not spoken to the carer about his aunt, but she overheard him say to the other children that he does not enjoy visiting her, because he does not get fed there. He has not mentioned anything about his parents to the carer, and she is not sure whether he has spoken to his friends about them.

According to the other carer, Kagiso has a very good relationship with his younger sister and brothers. He loves them very much. He prefers talking to the other carer, and loves playing soccer. He is a good, quiet boy, and does not fight with the others.

3.3 Pastor

Kagiso likes to be there for the pastor, and is always on his side. *“Sometimes when I look in his face, I can read in his face that, it’s something that I see in their faces, the need. ‘Pappa George, what can I do for you, how can I help you; Pappa George, I love you, you mean a lot to me.’”*

3.4 Teacher

Kagiso struggles with schoolwork. The teacher thinks that it is because his first language is Tswana. The teacher described Kagiso as lazy, *“I had to push him to do his work.”* Kagiso does not have any other problems, he always listens in class, and enjoys playing with the younger children. The teacher thinks that this may be due to the fact that Kagiso is respected by the younger children because of his age and height, and that he can play the role of a father figure for them. He does not have a specific friend with whom he plays, and he never fights with the other children at school. He sometimes playfully takes other children’s things. The teacher says that when Kagiso makes a mistake, he notices the shyness and guilt in his eyes. When disciplined, Kagiso just keeps quiet and listens.

4. Identified themes and categories

Table 5.11 presents the identified themes and associated subcategories from the information concerning Subject 6. The following table only presents this subject’s responses to the external realities listed in Table 5.11.

TABLE 5.11: Identified categories and subcategories (Subject 6)				
	External realities (stressors)	External supports	Inner strengths	Interpersonal, problem-solving skills
Communication mapping, River of life, Happy and sad.	Serious illness of family members Separation from parent Loss of primary caregivers Death Relocation	Supportive relationships <ul style="list-style-type: none"> • Father • Three friends • A close friend • Two good friends • Ntate Snyman • Mamma Lulu • Mamma Teboho • Mistress • Extended family (uncle and aunt) Supportive environments <ul style="list-style-type: none"> • Lebone 	Morality, social values and resistance skills <ul style="list-style-type: none"> • Against violent behaviour (i.e. fighting) • Values love • Avoids early involvement in serious relationships with the opposite sex Emotional management <ul style="list-style-type: none"> • Able to recognise feelings and control undesirable feelings Achievement motivation <ul style="list-style-type: none"> • Motivated to do well in school Optimism and positive identity <ul style="list-style-type: none"> • Positive view of personal future • Happy disposition Trust <ul style="list-style-type: none"> • Close friend 	Problem solving ability, self-efficacy and personal power <ul style="list-style-type: none"> • Belief in ability to exercise control over future and threatening situations Goal-setting, purpose in life and commitment to learning <ul style="list-style-type: none"> • Related to helping others Constructive use of time <ul style="list-style-type: none"> • Playing • Sports (i.e. Football) Creative activities (writing, cooking)
Additional identified subcategories				
Social worker	Restricted school attendance Poor care Neglect Learning difficulties Illness of siblings	Supportive relationships <ul style="list-style-type: none"> • Sister • Brothers 		
Carers		Supportive relationships <ul style="list-style-type: none"> • Friendships with younger children at school 		Obedience <ul style="list-style-type: none"> • He listens when disciplined

TABLE 5.12: Responses to stressors or adversities (Subject 6)		
External realities (stressors)	Initial thoughts, behaviour, feelings or emotions	Present thoughts, behaviour, feelings or emotions
<p>Serious illness of family members, death, and separation from parent</p> <p>Restricted school attendance</p>	<p>Kagiso's heart felt sore when his mother left him and his father passed away, and he cried and felt sad when he heard the news of his mother's death.</p>	<p>Kagiso still remembers his mother and has fond memories of her, but it makes him unhappy to think of her.</p>
<p>Relocation</p>	<p>Staying at Lebone makes Kagiso's river flow up again because he is loved by adults there.</p>	<p>Kagiso wants to stay at Lebone. The social worker describes Kagiso as a normal child. When the carer asked him about the nightmares he had been having, he said: "I don't know, I don't know." The carer finds this reaction strange because he usually talks to her. Kagiso is a very quiet boy who does not laugh a lot with the other children. He is often withdrawn and seems upset. He would then say to the other children that he feels tired and does not want to play or talk.</p>
<p>Poor care and neglect</p>	<p>Kagiso complains that he is not looked after, fed or bathed at his cousin's house.</p>	
<p>Learning difficulties</p>	<p>Kagiso is a slow learner. He told the carer about the subjects with which he struggles at school and that his teacher hit him for not understanding the work. The teacher describes Kagiso as lazy, and says that she must push him to do his work. Kagiso does not have a specific friend with whom he plays at school, and he never fights with the other children. He sometimes playfully takes the other children's things. When disciplined Kagiso just keeps quiet and listens. According to the teacher, Kagiso has no other problems. He always listens in class and enjoys playing with the younger children.</p>	
<p>Illness of siblings</p>		<p>Kagiso loves his two brothers very much. After school he often lies on the carpet and looks at them.</p>
<p>Being lost and other difficulties (hypothetically speaking)</p>		<p>Although Kagiso finds it hard to talk to strangers, he says that he would ask people the way home if he ever got lost.</p>

Adversities and stressors pertaining to Kagiso's family and home environment are the serious illness of family members, separation from his mother, death, the loss of primary caregivers, poor care, neglect, and the illness of siblings. In terms of Kagiso's school environment, his school attendance has been restricted and he experiences learning difficulties.

Kagiso's support network consists of relationships with three friends, a close friend, two good friends, his sister and two brothers, as well as a relationship with some of the younger children at school and at Lebone. Supportive adult relationships that form part of this network are those with his father, uncle and aunt, Ntate Snyman, Mamma Lulu, Mamma Teboho, and the educator at Lebone. Inner sources of resilience include morality, social values, and resistance skills, as well as emotional management, achievement motivation,

trust, optimism, and positive identity. Kagiso displays morality, social values and resistance skills as he is against violent behaviour or fighting, he values love and avoids early involvement in serious relationships with girls. Emotional management is indicated by his ability to recognise feelings and control undesirable feelings such as anger, fear and sadness. The supportive relationships he has with others, as mentioned previously, and in particular the relationship with a close friend indicate his ability to engage in trusting relationships. Kagiso is motivated to do well in school and displays optimism and a positive identity in his disposition and view of his future. Interpersonal and problem-solving skills that correlate with these inner strengths, particularly in terms of his future, are self-efficacy, a sense of personal power, goal-setting, purpose in life, and his commitment to learning. Kagiso uses open communication as a means of solving problems and conveying needs. Other interpersonal and problem solving skills are constructive use of time and obedience.

SUBJECT 7 - Bophelo

1. Biographic information

Bophelo was born on 11 December 1993. He is now 12 years old and in Grade 5. He lost his father to unknown causes and his mother to AIDS in August, 2000. His brother is 8 years old. Lebone became their permanent place of residence on 12 August, 2003. Bophelo's first language is Sotho. He also speaks English as a second, and Afrikaans as a third language.

2. Idiographic data

2.1 Communication mapping

Bophelo presented himself as a happy, friendly, and confident boy. He enthusiastically took part in the proceedings. He depicts himself as a happy boy, playing soccer, and appears amazed when the researcher tells him that he made a very good drawing. He asked "*really?*" He believes that he is very good at playing soccer and says that if he were given a hamster it would make him happy. He loves taking part in drama and that too, makes him happy. He wants to be an actor. Bophelo says that he has never been in an accident, but that he has witnessed two accidents a few weeks prior to this interview. This had made him sad. The drawings of the pastor, mamma Emelia, and Mistress, represent the people closest to him.



Figure 5.19: Bophelo. *Communication mapping* (2006). Pen on paper, 58 x 81cm

2.2 River of life

Between the first and third years of his life, Bophelo's river flowed up. "*I was getting everything I wanted, I was getting cared for.*" He was cared for by his mother. She was a pretty lady with fairly long hair. She wore earrings that made her particularly attractive. She had five pairs of earrings, and a special pair that was "*round, with a silver thing in the middle.*" His mother made him happy because they "*were going for fun.*" When he was three years old, "*we went to look for, like at the hall where there are clowns, people that do funny things, and riding on merry-go-rounds,*" in Botshabelo. Between the ages of four and six his river still flowed up, because he attended crèche and his mother read stories to him. He recalls the story of when Jacob went to steal sheep. "*The story is about Jacob and his friend. One day they went into the veld and then the friend saw other one stealing the sheep and eating it. While he was busy eating, these two went to tell the owner of the sheeps. While he was busy eating, in the meantime he was getting fatter and fatter and fatter. So, by the time the owner of the sheep came, he was too fat, he couldn't run.*" Bophelo drew a picture of their house in Botshabelo. His brother lived in a "*zink house, makuku*" next to theirs. The two houses were joined by a door, and they used an outside toilet. A peach tree grew next to their house. Bophelo is very fond of the brother because he "*was a football player, so when he went for training or matches, I used to go with him. He put me in a tire so that I can watch.*" He has another brother who lives in a different section of Botshabelo. He is "*mentally disturbed.*" Bophelo started to cry. He says that people laugh at his brother and told him that he is mentally disturbed. Bophelo says that he loves his brother and misses him very much. He last visited him two years ago with one of the caregivers from Lebone, and does not know if he will visit him again. Bophelo seemed deeply saddened and cried. The translator left the room to fetch something for him to dry his tears.

She returned with a roll of toilet paper and handed him a piece. He dried his eyes and said that he would be able to finish the drawing of his brother.

What made Bophelo happy about Botshabelo is the fact that his father was an army soldier. He recalls that his father previously worked as a truck driver. Bophelo was five years old at the time. His father was a runner. He worked out at the gym and had big muscles. Bophelo says that he was a strong, quiet man. He added the pictures of the people who lived in the house with him at the time: his older brother, younger brother, and parents. Bophelo last saw his father when he started school. He was seven years old then. They relocated to Bloemfontein and his mother fell ill that same year. His mother's illness saddened him, and he turned for comfort to his aunt who had cared for his mother. Bophelo cried again. *"It happened one day that they all wanted to go outside. They ask the mother to come outside, then she said no, I'll stay inside, you can go. So, all of us went outside. While we were still outside we were talking and then they sent me to go and watch her, look how she's doing or whether she needs something. I went to her on the bed and then, when I talk with her I tried to wake her up, she couldn't wake. That's when I realized that she passed away. I went outside to tell my aunt and sister, to tell them that she doesn't want to wake up, they came in, they touched him [her] here to feel the pulse [Bophelo illustrated with his hand how they had felt for a pulse], then they phoned, the ambulance, the ambulance people came. They put her on the stretcher and covered her whole body and told us that she had passed away."* Bophelo says that his younger brother was a small baby then, and he seemed very sad again. *"...And then the ambulance people took her, put him behind the ambulance. Aunt wanted to go with, but she didn't go."* Bophelo often thinks about that day. *"After some days the coffin came in a van then it was the burial."* Bophelo's river flowed down. He drew a sad face to represent that time in his life. His father did not know of his mother's death because he stayed in Botshabelo with his older brother at the time.

Bophelo's river flowed up again when *"a white lady"* took him to Lebone. He sat in the backseat of the car and could not see her. Therefore, he does not know whether she was a friendly lady or not. He does not know her name either. He was ten years old at the time. Bophelo says: *"People at Lebone do good things for us, important things to us."* He mentioned the names of six friends he made at Lebone. He enjoys playing soccer and cars with them. When it was his birthday he was given presents, a CD and computer game, and that made him happy about being at Lebone. Bophelo drew a picture of Lebone. He named the buildings he had drawn and said that he often speaks to the people who work in the garage. *"Some just say greetings everyday to us and then Abuti boy makes us stories."* He told them the story of the winner, and of the pig and the farm, first in Sesotho and then in English. Bophelo chose to tell the story of the winner: *"The winner was in competitions and he was winning, first time, second time, third time, fifth time, until he called himself, I'm the winner, that's why. He used to win all the games, one of the games was athletics, all the competitions, until he became the winner."* Bophelo says that he would also like to be a winner playing soccer. He enjoys going to school and likes his teacher because he teaches them Life orientation and Art. Although he previously enjoyed painting, he enjoys drawing more. His best subject is English. He says that the best people at Lebone are mamma Lulu, mamma Teboho, and Mistress, his favourite. He loves Mistress because she is friendly and gives them sweets. He says that she always shouts to them *"lets clean up!"* Mamma Emelia always cooks nice food for them and mamma Lulu pays their school fees.

Bophelo wants to drive a car when he is seventeen, and he is not going to have a girlfriend. He does not like girls, because “*they embarrass you, they embarrass you the way they talk, like action.*” The translator put her hand on her hip and pulled her one shoulder up, to illustrate what he had meant. He does not want to get married nor have children. He is afraid of having children because “*who will look after them if I’m not there?*” He said, however, that his younger brother is going to stay with him. “*He’s going to be my child.*” He wants to study Science at University, and then become a soldier at the age of twenty. He drew a picture of him as a soldier and a picture of him doing gym. He depicts himself with a moustache, big muscles, and a gun “*for crime, but I won’t shoot at a person to die, I’ll just shoot him at the feet so that he can fall.*” His river was still flowing up. During the session Bophelo seemed rather emotional at times. At the end of the session, he said that he had enjoyed drawing and wanted to draw again.

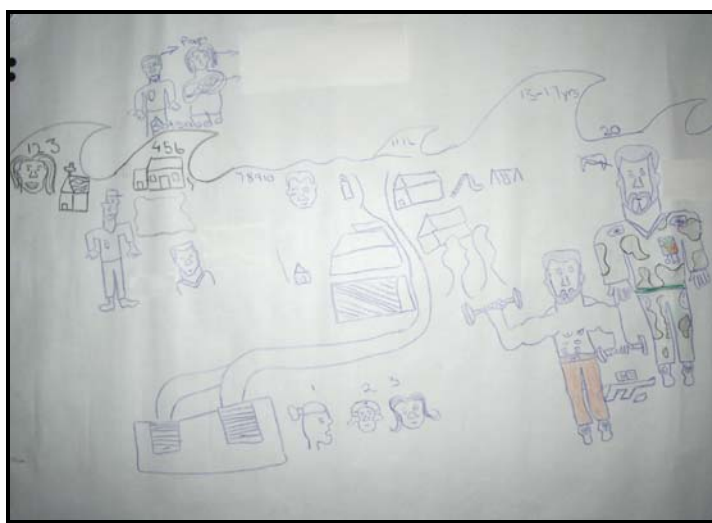

Figure 5.20: Bophelo. *River of life* (2006). Crayon on paper, 58 x 81cm

2.3 Happy and sad

The translator explained the task to Bophelo. First, he drew a picture of the saddest thing that happened in his life: an accident he saw a few weeks previously. When he saw the accident, he thought that the man was killed and he felt sad. Bophelo says “*the lorry went over the car,*” and the driver of the truck died instantly. The researcher then asked him about the death of his parents. His mother died last. He recalls the day she passed away, and says that it made him feel “*bad and sad. I was scared, I was thinking that I was not going to live a nice life again.*” He cried, and then they took his mother to the grave. After the funeral he went to his aunt’s house where he stayed for three years. While he stayed there, he occasionally visited his grandmother. One day, when he was playing outside his grandmother’s house, a white lady came. “*He come and fetch me and take me to the flat where the social worker works.*” He did not tell her that he was unhappy. “*A big man come and says he’s going to leave, then I came to Lebone.*” Bophelo says that he was taken to

Lebone because “*my uncle was shouting at us, because my aunt was not there.*” She received test results showing that she was ill, and she then abandoned her own children, Bophelo, and her husband. Bophelo says that his uncle also hit them, and that he does not know what the reason was for the beating.

Bophelo says that he no longer worries about the future and that he is happy at Lebone. His best friend at Lebone is Khaya. Bophelo says that playing soccer makes him proud, and tells about the world cup he saw on television. If he gets lost “*I’ll tell the police, say I’m living in Lebone. I’ll tell them that I’m twelve years, and I’ll tell them the address.*” He enjoys school, and his favourite subjects are Art and Science. The translator then asked him about his school report. He says that he felt bad about the report, but does not want the translator to tell the researcher why he felt that way. He smiled shyly and seemed embarrassed. The researcher asked him what he was going to do about that report and he said: “*I’m not going to give up.*” He feels that it has helped to talk about the sad things that happened in his life. He says that he can only talk to some people about what made him sad. He drew a happy picture of the 2010 soccer world cup.

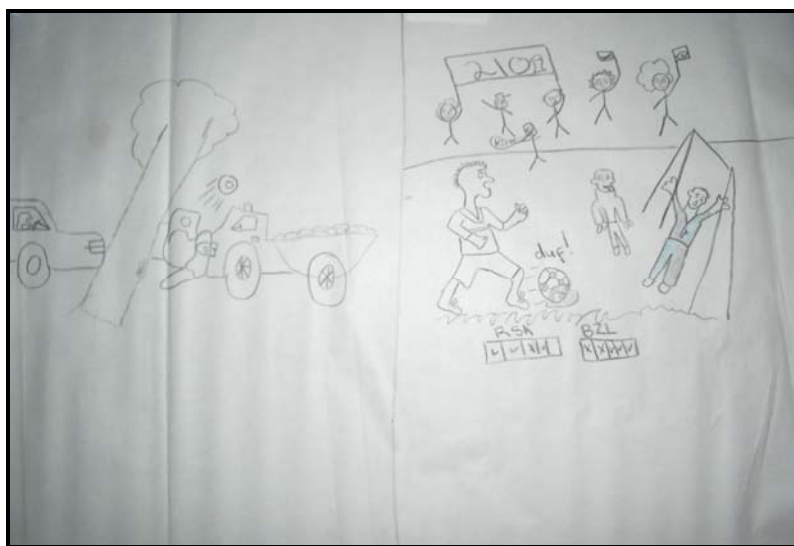

Figure 5.21: Bophelo. *Happy and sad* (2006). Crayon on paper, 58 x 81cm

3. Interviews held with key informants

This section presents the information gathered during the interviews with the key informants concerning Subject 7.

3.1 Social worker

Bophelo's aunt took care of his mother after she fell ill. At the time, his aunt and her daughter, now 10 years old, stayed at their house. After his mother's death, his aunt took his brother to Lebone. He was two years old then. She was unable to take care of him, because she was an alcoholic, and Bophelo's brother suffered from malnutrition and finally AIDS. The aunt promised to fetch Bophelo's brother from Lebone that Friday, but never returned. Thus, Bophelo's brother stayed at Lebone. Bophelo then went to live with his grandmother's sister, but eventually he was also taken up at Lebone. The two children still visit their aunt over weekends. When the children were taken home, they were usually left at the neighbour's house until the aunt came to collect them when she returned from work. On one occasion, one of the neighbours found them sitting outside the aunt's house at night. Their aunt had not returned home that day. Their uncle was home, but had refused to let them in. The neighbour then took the children to her house for the weekend. That Monday morning she took Bophelo's brother to the social workers who took him to Tswelang. He was referred to Lebone. The social worker from Lebone then learned that the aunt had left her husband and daughter permanently, without any word of her whereabouts. The neighbour was prepared to look after Bophelo, but not his brother, because he had diarrhoea. After some time, the social worker suspected that instead of focusing on the care and best interests of the child, the neighbour's motives for taking care of Bophelo were directed at obtaining grant money for her own use. According to the social worker, the neighbour had many grandchildren to care for, and had not provided sufficient care for Bophelo. He was then removed from the neighbour's house to be with his brother at Lebone. The social worker found guardians, an old lady and her husband, who were prepared to look after the two children over weekends. Bophelo, however, complained that the woman cared for his brother only, and did not pay much attention to him. The children have not visited their guardians again.

Bophelo told the social worker of a "granny" in Botshabelo whom he wanted to visit. In December 2004, the caregiver at Lebone took Bophelo to visit the "granny," but he was a stranger to her. According to the caregiver, the woman was not related to him. The social worker was unaware of the brother in Botshabelo, to whom Bophelo had referred. She guessed that he was probably extended family. She also had no other information about Bophelo's father, except that he was a soldier, that he fell ill and passed away before Bophelo's mother died. In December 2005, two ladies visited Lebone. They claimed to be related to the children. They were interested in taking care of them, and promised to visit Lebone again to make further arrangements, but they never returned. Bophelo has asked to visit one of the neighbours, also an older woman, in the township where his uncle lived. In 2006, he visited her for three days, but when he returned to Lebone he told the social worker that he did not want to go there again, because there was no food.

The social worker finds it difficult to describe Bophelo, because he would listen to some people, but become very angry if others disciplined him in the same way. He often lies and craves attention. *“He likes to saying stories that are not like that. If you give other child something, if you don’t give him, he’s crying. Especially if the other children, they go home, if it’s on school holidays, he just cried.”* He failed his school exams in June, and hid himself in the bathroom and cried. Gloria told some of the other children that it was not right that they had failed, but Bophelo was not prepared to listen. The social worker describes Bophelo as a child who does not like being told if he is wrong. *“You must say always, no you are good, no you are doing right; and then all the good things, you must always give it to him, not to the other children. He likes to be the leader, and the others they look at him and listen to him. He’s good in a way, but he’s got that thing of the child, you know how’s the child.”* The social worker also thinks that his behaviour may be due to the fact that the various people with whom he stayed perhaps pitied him because he lost his mother. She explained to him that *“here we don’t have that thing, they’re all the same. You don’t have a mother, but that is not the end of life. We are here for you to help you.”*

3.2 Caregivers

The carer describes Bophelo as *“a nice guy.”* He is a happy child most of the time, but when he is tired he does not want to play. Then he usually watches television. Bophelo enjoys being in charge of the other children. Bophelo prefers to play with the older children and the babies. He told the carer that the younger children do not listen to him and always take his things outside. He loves his younger brother very much. The carer feels that he respects her a lot. He likes making jokes with her. He would ask her and one of the ladies who works in the kitchen to help him find someone that he could marry. He feels that the carer is getting old and says that his wife would help her to clean the house. He often pokes fun at her and reminds her of his request. She says that he enjoys playing with bicycles, drawing and watching wrestling on television. The carer mentions that he also made her a card to say that he appreciates her.

According to the other carer, Bophelo is naughty. He tells the other children to keep quiet because he wants the carers to listen to him only. He loves playing soccer and wants to be praised if he plays well. He is jealous of others who receive praise. He talks a lot to her about school. He enjoys school very much. Bophelo told the carer that he wants to become a psychologist.

3.3 Pastor

Bophelo comes from a difficult background. He was rejected by his parents and was not looked after properly. Bophelo took care of the younger children in the house. *“Everything was on his shoulders.”* When Bophelo relocated to Lebone, he was taken to a child psychologist. The pastor says that he was very depressed, discouraged and withdrawn. *“You can see that he’s asking himself, ‘why these things have happened to me.’”* A teacher from one of the schools in town helped him with his homework. On the way back to Lebone the pastor often took him to Mimosa Mall to do some window shopping or parked the car

somewhere and played and ran with him. *“But sometimes you’ll find that something came to his mind, something like this, ah, if only this moment can last forever, and I can read that on his mind.”* The pastor describes Bophelo as a quiet boy. For this reason he is concerned about Bophelo’s future.

3.4 Teacher

“Sometimes he’s bully, I don’t know what has happened to him, but at times he’s that boy who can understand, who can do his work. It’s because he’s naughty, I don’t know.” He hits children with his fist while the teacher is teaching. *“So he’s disturbing me at times.”* He is not a fighter, but he hits other children if they, for instance, take his pen. Instead of reporting the incidence to the teacher, he always tries to handle the situation himself. He listens to the teacher when she disciplines him, but then is naughty again. He listens to the teacher, and understands when she speaks to him, and he then asks for forgiveness. The teacher has forgiven him *“as a child.”*

4. Identified themes and categories

Table 5.13 presents the identified themes and associated subcategories from the information concerning Subject 7. This subject’s initial and present responses to the external realities listed in Table 5.13 are merely presented in Table 5.14.

TABLE 5.13: Identified categories and subcategories (Subject 7)

	External realities (stressors)	External supports	Inner strengths	Interpersonal, problem-solving skills
Communication mapping, River of life, Happy and sad.	<p>Serious illness of family members</p> <p>Loss of primary caregivers</p> <p>Death and funerals</p> <p>Car accidents</p> <p>Negative gender-based relations</p> <p>Abuse</p> <ul style="list-style-type: none"> • Uncle <p>Abandonment</p> <ul style="list-style-type: none"> • Aunt 	<p>Supportive relationships</p> <ul style="list-style-type: none"> • Parents • Grandmother • Worker at Skills Development (Lebone) • Aunt • Two brothers • Pastor • Mamma Emelia • Mistress • Mamma Teboho • Six friends <p>Supportive environments</p> <ul style="list-style-type: none"> • School • Lebone 	<p>Morality, social values and resistance skills</p> <ul style="list-style-type: none"> • Against crime • Caring for others • Values love • Avoids early involvement in serious relationships with the opposite sex <p>Achievement motivation</p> <ul style="list-style-type: none"> • Motivated to do well in school <p>Optimism and positive identity</p> <ul style="list-style-type: none"> • Positive view of personal future • Happy disposition • Pride (soccer) 	<p>Problem-solving ability</p> <ul style="list-style-type: none"> • Able to find or ask for help <p>Self-efficacy and personal power</p> <ul style="list-style-type: none"> • Belief in ability to exercise control over future and threatening situations <p>Goal-setting, purpose in life and commitment to learning</p> <ul style="list-style-type: none"> • Related to helping others <p>Constructive use of time</p> <ul style="list-style-type: none"> • Playing • Sports (i.e. Soccer) • Viewing sports on television <p>Perseverance</p>
Additional identified subcategories				
Social worker	<p>Alcoholism</p> <ul style="list-style-type: none"> • Aunt <p>Rejection</p> <ul style="list-style-type: none"> • Uncle <p>Separation from sibling</p> <p>Poor care, neglect</p> <ul style="list-style-type: none"> • Aunt • Guardians • Older woman (neighbour) <p>School failure (Learning difficulties)</p>	<p>Supportive relationships</p> <ul style="list-style-type: none"> • Grandmother's sister • Neighbour • Social worker from Lebone 	<p>Authoritative & Leadership</p> <ul style="list-style-type: none"> • Children listen to and look up to him. 	<p>Communication</p> <ul style="list-style-type: none"> • Reports poor care to the social worker
Carers		<p>Supportive relationships</p> <ul style="list-style-type: none"> • Babies and older children at Lebone • Younger brother • One of the kitchen staff 	<p>Assertiveness</p> <ul style="list-style-type: none"> • Taking charge of other children <p>Humour</p> <p>Morality and social values</p> <ul style="list-style-type: none"> • Respect • Shows appreciation (carer) 	<p>Constructive use of time</p> <ul style="list-style-type: none"> • Riding bicycle • Drawing <p>Communication</p> <ul style="list-style-type: none"> • Talks to the carer about school
Pastor	<p>Rejection</p> <ul style="list-style-type: none"> • Parents <p>Poor care</p> <ul style="list-style-type: none"> • Parents 	<p>Supportive relationships</p> <ul style="list-style-type: none"> • Child psychologist • Teacher from town 	<p>Responsible</p>	

	External realities (stressors)	External supports	Inner strengths	Interpersonal and problem-solving skills
Teacher			<p>Independence</p> <p>Morality and social values</p> <ul style="list-style-type: none"> Asks for forgiveness 	<p>Commitment to learning</p> <ul style="list-style-type: none"> Does his schoolwork <p>Obedience</p> <ul style="list-style-type: none"> He listens when disciplined

TABLE 5.14: Responses to stressors or adversities (Subject 7)

External realities (stressors)	Initial thoughts, behaviour, feelings or emotions	Present thoughts, behaviour, feelings or emotions
Serious illness of family members, death, funerals and loss of primary caregivers	Bophelo felt sad when his mother was ill. He turned to his aunt for comfort . When Bophelo realised that his mother had passed away, he went outside to tell his aunt and sister that she will not wake up . He cried and said that he felt bad and sad . He thinks that he is not going to have a nice life again .	Bophelo cried and seemed deeply saddened when he told the researcher about his brother who is mentally disturbed. He loves his brother and misses him very much . When Bophelo speaks about the time of his mother's illness he is tearful and seems sad . He often thinks about the day she passed away . He has fond memories of his mother. Bophelo does not want to have children because he is concerned about what would happen to them if he passed away . When the other children go home for the school holidays Bophelo cries .
Relocation	Although Bophelo was depressed, withdrawn and discouraged when he relocated to Lebone, he says that his river flowed up again when he was taken to Lebone.	He believes that the people at Lebone do important and good things for them . Bophelo listens to some people, but becomes angry if others discipline him in the same way. He is jealous, often lies and craves attention . Bophelo does not like to be told that he is wrong . He only wants to be praised . When the other children are given something and not Bophelo, he cries . He likes to be the leader . The social worker attributes his childish behaviour to the fact that the people with whom he stayed pitied him because he lost his mother. The carer says that Bophelo is a happy child most of the time, but when he is tired he does not want to play . Then, he watches television . Bophelo enjoys being in charge of the other children and prefers to play with the older children and the babies . Bophelo likes joking with the carer and one of the ladies who works in the kitchen. He respects the carer and made her a card to say that he appreciates her . The pastor describes Bophelo as a quiet boy .
Car accidents	Witnessing car accidents has made Bophelo sad , because he thinks that the man in the truck has been killed .	
Crime		Bophelo wants to become a soldier . He will use his gun to fight crime . He says that he will not kill people, but only injure them to prevent them from committing a crime .
Negative gender-based relations		Bophelo does not like girls . They embarrass him by their mannerisms and the way they talk. He does not want to get married .
Abuse		Bophelo does not know why his uncle beat him .
Separation from sibling		Bophelo loves his brother and misses him very much . He does not know if he will visit him again .

External realities (stressors)	Initial thoughts, behaviour, feelings or emotions	Present thoughts, behaviour, feelings or emotions
<p>Poor care and neglect</p> <ul style="list-style-type: none"> • Aunt • Guardians • Older woman (neighbour) 	Bophelo complains that the woman cared for his brother only, and did not pay much attention to him.	Bophelo took on the care of the younger children in the house.
School failure	Bophelo did not want to listen when he was told that failing the term was wrong. He hid himself in the bathroom and cried .	
Teasing	When the children in the class take Bophelo's things he hits them with his fist . He always tries to handle such situations independently . He listens to the teacher when she disciplines him, but is then naughty again . When the teacher speaks to him alone, he listens to her and asks for forgiveness .	

Adversities or stressors which Bophelo faced in his family and home environment are the serious illness of family members, death, funerals, loss of primary caregivers, alcoholism, abuse, abandonment, rejection, and poor care. Bophelo also witnessed two car accidents that made him feel very sad. Negative gender-based relations are evident considering his views towards girls of his age. He also failed a term at school and is sometimes mocked by the children in his class.

Supportive relationships within his family are those he has with his two brothers and his parents. During his mother's illness and after her death, his grandmother, his grandmother's sister and his aunt in particular provided support. A neighbour provided support in terms of temporary shelter and accommodation. At Lebone he has established supportive relationships with one of the workers at Skills Development, one of the kitchen staff, the pastor, the social worker, Mamma Emelia, Mistress, Mamma Teboho and six good friends. Bophelo has a close relationship with his younger brother and also enjoys playing with the babies and the older children. Other supportive relationships are with the child psychologist and a teacher from one of the schools in town.

Inner strengths revealed through these and other relationships are morality, social values, resistance skills, obedience, independence, and responsibility. Morality, social values, and resistance skills are particularly evident as he is against crime and believes that it is wrong to commit murder unless it is in self-defence, he cares for others, values love, shows respect and appreciation, asks for forgiveness when he has done something wrong and avoids early involvement in serious relationships with the opposite sex. Obedience and independence are indicated: he listens when he is disciplined in class and instead of reporting the incident to the teacher, he tries to handle adversities independently. Self-efficacy, a positive identity and goal-setting are suggested as he wants to be a winner. The sense of pride he derives from playing soccer denotes a positive identity. Bophelo took on the care of the younger children in the house. This points to a strong sense of responsibility. Achievement motivation, optimism, and positive identity linked with goal-setting and purpose in life, commitment to learning, self-efficacy and personal power given his self-concept, disposition and future

projections. Taking charge of the other children suggests assertiveness. In counteracting adversities and stressors, Bophelo also exhibits interpersonal and problem-solving skills such as communication and humour. He reports poor care to the social worker and often talks to one of the caregivers about school. He often jokes with the caregiver too, which denotes a sense of humour. Playing with friends, doing sports, riding bicycle, drawing and watching television suggest constructive use of time, and perseverance is indicated by his aim to succeed, in spite of failure. The school and Lebone are considered domains of influence and support.

SUBJECT 8 - Zandi

1. Biographic information

Zandi's was born on 28 September 1994. He lost both parents to AIDS and has lived at Lebone since the beginning of January 2003 with his brother, aged 4, and two sisters, aged 8 and 9, respectively. He is now 12 years old and in Grade 5. He visits his grandmother in Pieter Swartz, a township near Bloemfontein during school holidays. His home language is Sesotho, and he speaks English as a second language.

2. Idiographic data

2.1 Communication mapping

Zandi portrays himself as a happy boy, waving at people on his way to school. To this self-portrait he adds a picture of his four year-old brother, Tumeleng, Willem's bakkie, Rist House, a soccer field and spectator, Lebone House, and a cat. Willem often fetches them from school in the bakkie, and Zandi loves riding in it because "*it shakes*." He wiggles his body and shakes his hands to show the researcher what he means. He likes Rist House because he sleeps there. Besides other boys, Zandi shares a room with his friend, Bophelo. Rakgadi who cleans the house, cooks food and makes lunchboxes for them, also sleeps in the house. His clothes are also kept at the House where he changes after school. He enjoys watching television in the house. Zandi loves playing soccer. He plays number twelve, and his favourite team is Kaiser Chiefs. The spectator he drew is unknown to him. Besides soccer, he enjoys playing rugby and doing karate. Zandi cannot give a reason why, but he asks the translator not to talk about one of the drawings. He agrees to name the drawing though, and the researcher continues questioning him about the other pictures.

The researcher asked Zandi to tell her a story, using all the pictures he had drawn: "*One day I was coming back from school, then I went to the Rist house to change clothes. Then after changing clothes, went to, we went to play soccer, then after playing soccer we went to the house to have food. After eating we went to the dining room to watch TV, whatever was there, we were watching. Then after watching TV, we came back to the Rist House, prepared for bedtime, then we slept all night long. In the morning we woke up, went back to the Lebone House, for breakfast, then we rode on Venture to take us to school. After school we came back.*" The researcher pointed out that he has not used some of the pictures. He continues with the story. "*After school, I came, and then I greet everyone at Lebone here. Then we came to do homework.*" Again the researcher reminded him of some pictures he has not included. Zandi says that he is not going to use the picture of Willem's bakkie because "*I'm not riding on it every day. We use the Venture. After school then I come to check on Tumeleng.*" He then speaks about the drawing he did not want to talk about at first. "*In the evening when we're at the house, we always see the cat there on top of the house.*" It is a brown cat.

Although he has held other cats before, he has not held this one. Although he cannot give a reason why, he says that he does not like the cat. He then continues: *“That spectator was watching us while we were playing and after the match, he was the one that was telling us, who was the best man or who was the rough player. He said I play good, but I must not play to much in front, I must play at the back because the other team scored us while I was playing in front instead of playing at the back.”*

Zandi drew the faces of his grandmother, mother, aunt, and father’s sister, to represent the people who mean the most to him, and who care a lot about him. The picture he previously drew of his younger brother, Tumeleng, forms part of the circle of faces around his picture. He adds names to the pictures and numbers each drawing in terms of importance. His mother is numbered, one, his grandmother, two, his aunt, three, younger brother, four, and his father’s sister, five. Of all those people, he loves his mother and grandmother the most. He is also the closest to them. He then says that, although his mother passed away, he trusted her the most. Now, his grandmother, whom he usually visits during the school holidays, is the person he trusts most *“because she is my mother’s mom.”* They speak a lot. He can talk to her about anything. Zandi also speaks to her about problems. He loves her *“because she also loves me and buys me whatever I want.”* If she is not around he speaks to his aunt about problems. At Lebone he speaks to mamma Teboho and Mistress. Zandi spoke to her about the rape of his younger sister, Kamohelo. *“My mother sent her to the shops. The distance of the house to the shop is from that house, Lebone House to the Wendy House. Then there’s, other man, that man, he was half way. He called her on her way back to say he’s going to give her a sweet. Then he took him, he took her to the house and raped her. The wife, that person that was raping Kamohelo, his wife came to the house and then she found the husband was raping Kamohelo, and then the husband ran away. When that woman found Kamohelo being raped, she left Kamohelo in the house and she ran to our house to report that, and she left Kamohelo crying in the house. My father was still gonna come. My big brother was still gonna come at home, he was not there yet. Then, when my brother came, he organized his friends and then they chased that man that raped Kamohelo and they beat him with shamboks and stuff. And then he was taken to jail. I don’t know where he is now, he ended up being caught. After they took Kamohelo to the clinic, when I got to my mother, she said that Kamohelo has run away, but Kamohelo was hiding under the chair, sleeping there.”* Zandi continued to talk about his mother. *“She died because she was sick, she couldn’t even hold the food or eat, she was always shaking when she was holding something in her hand.”* The researcher asked him about his sister again. Zandi says that he heard the news from the wife of the man who raped his sister. He does not know what rape means, but thinks that *“it’s bad, it’s hurting.”* He does not know exactly what happened to his sister, but says: *“I saw Kamohelo was full of blood, the blood was coming from his [her] panties.”* He saw the blood on her clothing *“when my mother took the panty to wash it.”* Zandi often thinks about that day. He then clarifies the sequence of events. *“My mother went to go and fetch her, and then they came home, so they didn’t go after that man, only when I saw him one day, because when the wife of that man came to the house finding him raping Kamohelo that man left Kamohelo and ran away, so he thought he was escaped.”* The man has not returned to his house since the incidence. *“They didn’t catch him the same day, but later. It happened one day that I saw that man passing, before he was caught. When I saw that man, I noticed that it’s him, the guy that did this to Kamohelo. I went to my brother to tell him, ‘I saw the man.’ I pointed at him and he was going that other direction, so my brother took pangas and stuff, called*

other friends and they approached him in different direction.” Zandi says that he did not feel scared when he saw him that day. He wishes that that man came to him so that he could take him to his brother’s house to be beaten. When he told mamma Teboho the story she just listened, but seemed shocked to him. Zandi says that it makes him sad to think about what happened. When the researcher asked what makes him sad, he says: *“I don’t know what to say.”* He feels angry because his sister has been hurt. The researcher then asked him what he is thinking at present. He replies: *“I feel like going back to beat that guy,”* because *“he hurt my little sister.”* Zandi feels that the man did something very wrong. Although he does not believe that it is good practice to beat children when they have done something wrong, he believes that it is right to beat adults who have wronged others. The researcher asked whether it is better for the man to be beaten or punished by being taken to jail. He says that the man should be beaten and taken to jail. He is, however, worried about going to jail himself if he beats others. Instead, he says that it would be more appropriate to report to someone. Nevertheless, he thinks that, if that were to happen again, *“I can do it both ways. I can beat him first and then report him, or report him and then beat him.”* He says that if he saw the man again he would not say anything to him, but would tell his grandmother that he saw him. He says that if he had to see the man now, he would feel afraid. He agrees that he is safe at Lebone and that the man will not come there.

Zandi dislikes smoking. He says: *“Rakgadi, we always ask Rakgadi to stop smoking, but he never stops, so that bothers me.”* He says that he never thinks about his mother when he is at Lebone. When he visits his grandmother they always play puzzles together. Of his aunt he says that *“she’s not always at home, she’s always at work.”* Zandi does not know where she works, but that she is a builder. He occasionally sees her during the school holidays. He likes her because *“he [she] will sometimes bring me stuff, and when my mother was sick, he [she] was helping my mother.”* She was a pretty lady with *“big, long hair.”* Then Zandi says that he thinks of her often. He recalls that she fought with his father. He found them fighting when he came home one day. He tried to stop them, but they did not listen to him. His mother took a big stone, and threw it against his father’s chest. His father was badly injured and was taken to the clinic from where he was referred to hospital. Zandi received a phone call the following morning to say that his father had passed away. Zandi went to the mortuary with his grandmother to view his father’s corpse. It made him feel sad to see his father dead as he recalls that his father always used to buy him *“nice stuff, anything I wanted.”* Zandi only saw his face, but he still remembers exactly what he looked like that day. *“He was changed, at the mouth.”* That too, made him feel sad. He says that he sometimes thinks of that day. He remembers that his father had promised to buy him a bicycle, but he never did. There was nothing more he wanted to say about his father, except for the fighting. He says that he was scared that day. His mother died a long time ago. Zandi says that he cannot remember that far back. At first, Zandi did not know what to say about his younger brother, Tumeleng. Then he said that he makes him happy because he is funny. *“He always does like triple H do, wrestling.”*

The researcher shifted the focus back to the picture of Zandi. When the researcher asked him what he would do if he got lost, he said that he would never get lost. The researcher rephrased the question and said that she had meant hypothetically speaking. He then said that he would ask people where he could find a phone. If there were no phones, he would look for transportation to take him to a familiar place or to where he was from. He finds it easy to talk to strangers. He can talk to them about anything, except problems. He did not

know what to say when the researcher asked him what made him happy. She then asked about sport and he said that he enjoys playing soccer and doing karate. He wears a green belt in karate. He wrote down the names of his friends in Lebone and at school. He has more friends than the names he wrote down, but says that he only wants to write down the ones he has, because he loves these the most, and they also love him. His best friend is from school. Zandi enjoys school and is fond of his teacher. The researcher noticed that he did not once mention his older sister who is also at Lebone. Although he answered that she is also important to him, he did not have anything to say about her. He agrees that she would fit with the important people in his life that he had drawn and added her name to theirs. The researcher asked whether he talked to her and he said that they do talk about schoolwork or what they did at school. Zandi wishes to own a bicycle. He wants a bicycle for a birthday present.

Zandi drew a picture of people walking, with two of his friends over the weekend, before this interview. He does not know where it was. He promises to show it to the researcher at the next session, if he finds it. Although Zandi seemed like a serious boy, he is friendly and confident. He played with the pens in a relaxed manner throughout the session.



Figure 5.22: Zandi. *Communication mapping* (2006). Pen on paper, 58 x 81cm

2.2 River of life

Zandi was reluctant to draw the river of his life. The researcher asked a few questions about the first three years of his life. He could not remember anything from that time, and did not have a photograph that was taken during that time either. Still, he did not want to draw. The researcher tried to encourage and reassure him, but he remained unsure. The researcher continued questioning him and asked about when he was four years old. He could not remember anything. She then made an example of his younger brother who is five years old. Zandi says that he can remember a little from the time he was the same age. He then recalled that he was born in Botshabelo. He lived there with his parents, two sisters, grandmother, his uncle's and his wife until he was eight years old. It was a two-bedroomed house with a living area. Zandi slept with his uncle and sister, and his grandmother slept with his younger sister, *Kamohelo*. The other people had their own beds. He enjoyed living with all the people in the house. Zandi says that they were always happy. He had two friends with whom he played ball and soccer; that made him happy. His river flowed up. When the researcher asked him to draw a picture to represent that time in his life, he looked unsure. She then suggested that perhaps he could draw their house in Botshabelo and the people living in it at the time, and he agreed. The translator had to leave the room for a while. The researcher asked Zandi to name all the people in the picture, and she wrote all the names down. The translator returned. Zandi had never gone to crèche or pre-school, but stayed at home. He started school in Botshabelo at the age of eight. On his first school day his father took him to school, and he recalls that the teacher showed him around. He was eager to start school, and he met a lot of other children. Zandi also made a good friend at school. He did well at school, and was happy, particularly because he played soccer with his friends. His river still flowed up.

When Zandi was ten years old, part of his family had relocated to a township near Bloemfontein. Zandi, his mother and sisters moved to his uncle's house, and his grandmother moved to Phase 4 of the same township. His father stayed in Botshabelo with his uncle and aunt. Zandi said that this was not an enjoyable experience, because he did not know the people. Although he found it easy to make four new friends with children who lived nearby, he says that "*it was not good times.*" His river flowed down, but he enjoyed the new school he attended.

At the age of eleven he still lived with his family in the township near Bloemfontein, but had moved to another school. He remained in the new school until he turned twelve. He was then relocated to Lebone, and attended a different school again. He does not know why he was taken up at Lebone, but says that his granny took him there. When the researcher asked if he had seen his parents after he moved to Lebone, he replied that they had already passed away. His father passed away when he was six years old, and his mother when he turned eleven. Even though his river flowed down at the time, the friends he made at the new school made it easier for him. At first, Zandi decided to draw a picture of the house they lived in at Botshabelo, but he changed his mind and drew a picture of the school and the friends he had made there, because he says that he loved the school. He had nice teachers there as well. When he moved to Lebone his river flowed up.

Zandi has not given much thought to his future, but when the researcher asked him what he wants to do, he said that he wants to finish school. He foresees his river flowing up during high school, because then he will be able to help the younger children with homework. He only wants to have a girlfriend when he is twenty years old. He will stay at Lebone until then and work in the skills development section, and then leave to go and live with his grandmother in the township. He is not fond of girls, but has no reason for disliking them. After school Zandi wants to work as an apprentice at his brother's work. His brother works as a motor mechanic. Zandi wants to get married, but does not want to have children. He has not thought about the reason for not wanting children. He thinks that he will eventually move to Johannesburg, where his uncle lives. There he will live in a house of his own. He drew a picture of his prospective house. There was nothing more he wanted to add to the picture that represents his future, but says that he will draw the "Lebone candle." The researcher asked what he thinks when he sees that symbol, and he said that his only thought is that it gave light when there is no electricity. In conclusion, Zandi said that he thinks that he has had a happy life. He agrees that the happy times outweighed the sad times. He does not find it difficult to grow up without his parents, and says that he never thinks about them or feels sad about their absence.

During the session, the researcher detected a strong smell and gathered that Zandi had soiled his pants before he came to the session. She suspected that this may have contributed to the fact that he seemed more reserved, uncomfortable and reluctant to take part at times. Although he does not seem so keen, he says that he would be pleased to draw again at the next session.

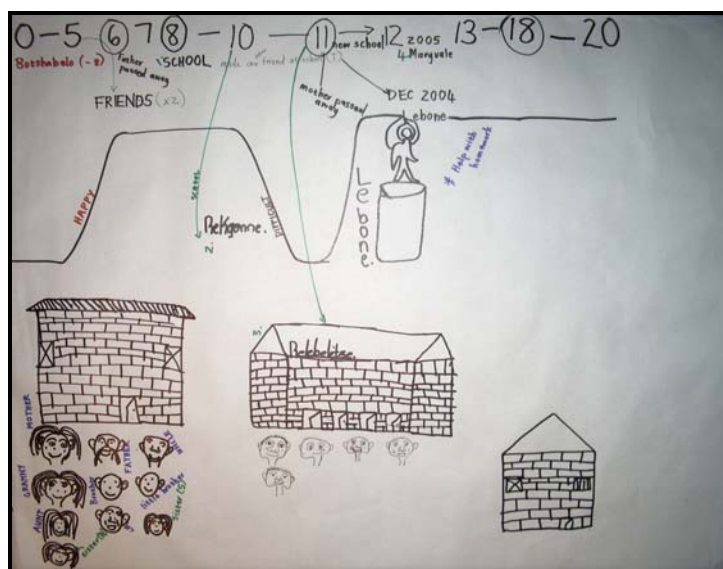

Figure 5.23: Zandi. *River of life* (2006). Pen on paper, 58 x 81cm

2.3 Happy and sad

The researcher greeted Zandi as he entered the room, and asked whether he wanted to draw. He enthusiastically replied that he would. He seemed pleased that he was allowed to draw anything he felt like. He sat down and looked around. He attempted to copy a picture of a cake that was stuck to the wall. The translator then interrupted and suggested that he draw his own picture. He then drew a picture of the “*school house*.” The picture he started at first was then viewed as a banana. He had no specific reason for choosing to draw those pictures, but said that “*it’s just for drawing*.” The researcher then asked Zandi about the previous week at school. He had done reading and writing that week. He had had a good week, and said that he was doing well at school. He seemed more comfortable and relaxed, and the researcher explained that day’s task to him.

He closed his eyes and listened for sounds that he could hear. He heard a humming sound, people outside, people using a spade, and birds. The researcher then asked him to focus on the thing that hurt or had hurt him the most. He replied that there was nothing. She asked him whether there had been a time when he had felt very sad about something or had cried, and he answered that the school children made him cry. They had hit him once. He did not know what their reason was, but it had made him cry. Afterwards, he told the teacher, and the teacher reassured him that he would talk to them. The researcher asked whether it had hurt his heart when the children had hit him, and he replied that it had not hurt his heart. Once again, she asked him to think of something that hurt or had hurt his heart, and Zandi then mentioned the death of his mother. He said that his heart still feels sore about having lost her. Again he says that he does not think about her. There is nothing else he could think of that hurts him. Zandi opened his eyes. He said that when the children at school had hit him, he had not thought of anything, but had felt bad. Zandi said that he was unable to draw a picture of what had happened at school that day. The researcher then suggested a few possible drawings and he agreed to draw a picture of when he had gone to tell the teacher of what had happened. He said that the children had only hit him once. The incidence took place the previous week. They had hit him in the back with their hands, but it had not hurt that much. When the researcher asked Zandi whether he would be willing to draw a picture of the day he lost his mother, he agreed. When he had finished his drawing the researcher asked him to tell her the story of what had happened that day. At first he said that he could not recall anything, and the researcher continued questioning him. He then said that he was at home with his grandmother that day. His mother had passed away in the clinic and he had heard the news from a neighbour. He had been very sad and upset. He had cried and had then gone to help his grandmother in the house. Zandi does not know the cause of her death. He attended the funeral with his grandmother and mother’s friends. He did not know the reason, but his eldest sister stayed at home. Again, he said that he had loved her very much, but did not miss her or think about her at all. He agreed that he is happy at Lebone now, and that there are many people who care for him. Knowing that had made his heart better when he came to Lebone. It also caused him not to miss his mother a lot. At first, he said that he had no good memories of her, but then he looked at the drawing he had made and recalled that there had been something that they had done together that had made him happy. His mother had taken very good care of him and she had bought him anything he wanted. She was a pretty lady. He recalled the time she promised to buy him a bicycle, but never did, because she had fallen ill and then died.

Zandi closed his eyes again and made a wish. He said that if he were given a fingerboard, that would make him very happy. He drew a picture of a fingerboard and explained the game to the researcher. At Lebone his friends make him happy. He particularly enjoys playing bicycles and games with his friend, Bophelo. He drew a picture of them playing soccer together.

Zandi drew a picture of a teddy bear to say good bye. The researcher said that she would think of him if she saw a teddy bear. He said that he would remember her too, if he saw her at Lebone again. He gave the researcher a big hug, and left.

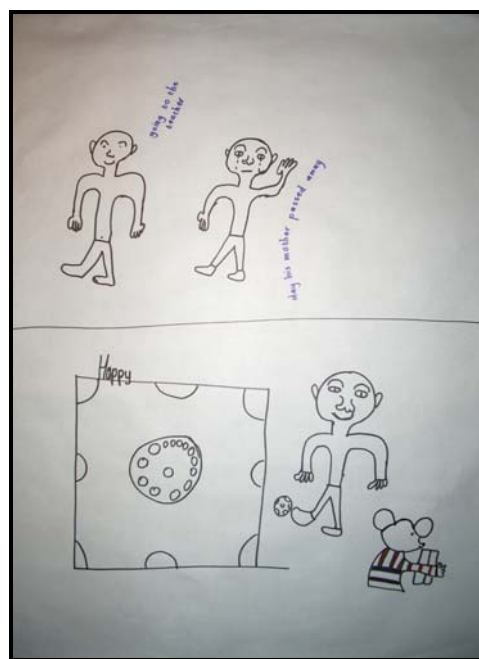
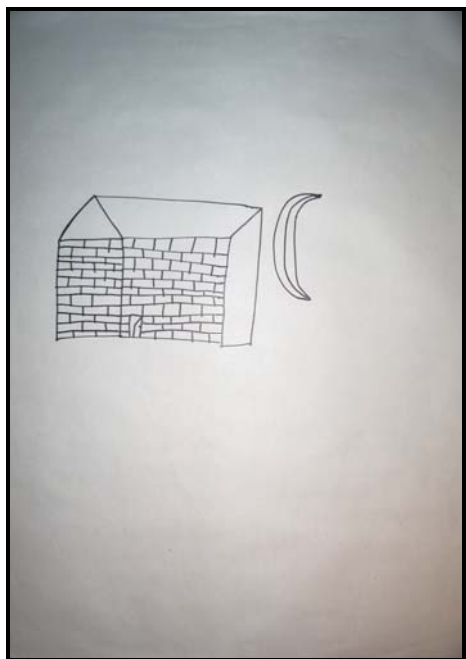

Figure 5.24 (left): Zandi. *Preliminary drawing* (2006). Pen on paper, 58 x 81cm

Figure 5.25 (right): Zandi. *Happy and sad* (2006). Pen on paper, 58 x 81cm

3. Interviews held with key informants

This section presents information concerning Subject 8 that was gathered during the interviews with two of the carers and the pastor at Lebone, as well as a teacher at Shanon Intermediate School.

3.1 Social worker

Zandi's mother was raised by her mother's sister. His mother lived in Bloemfontein and never married. Zandi's father was only a boyfriend to his mother and did not live with them. When Zandi's mother fell ill and

passed away, his grandmother, who lived in Johannesburg relocated to Bloemfontein and took care of Zandi, his brother and two sisters. She lived in a small shack, had no child support grant, and struggled to cope with the care of the children. The social worker from Lebone visited their home and removed all the children, except Zandi. He stayed with his grandmother because he was enrolled at a school in the location and it was the middle of the year. The social worker noticed that Zandi's eyes were terribly red and swollen, and she assumed that the dust and wind had irritated his eyes because he walked quite a distance from home to school everyday. A year later, Zandi's grandmother contacted the social worker and asked for her to take Zandi as well because he was unhappy. He missed his brother and sisters. Zandi was then accommodated at Lebone.

3.2 Caregivers

Zandi often fights with the other children, and mostly with Bophelo. They would hit each other, and the carer would then have to stop them. Zandi usually stays angry for the entire day, and would not apologise. It would take a long time for him to forgive Bophelo and play with him again. Zandi usually listens to the carer. He does not have a close relationship with his sister and does not play with his younger brother. He often speaks to the other carer.

According to the other carer, Zandi would often be naughty, especially if he had visited relatives in the township. He would behave like an adult. She describes his behaviour as "*wild*." He is jealous, aggressive and fights with the younger children. This behaviour would usually only last a day or two. She told him that at Lebone they are considered children, not adults. She warned him to listen to her when she speaks, and said that if he wants to fight he should fight with her instead of picking on the younger children. He did not take her up on the offer and apologised. He promised not to behave in that way again. He told the carer that he wanted to become a doctor.

3.3 Pastor

Zandi would sometimes fight with the others, but the pastor said that Zandi is not a troublemaker. He viewed his behaviour as that of a normal child. The pastor describes Zandi as a "*bossy guy*," but he meant it in a good sense. Zandi is responsible, accountable and loves to organise and reprimand the other children. In this sense, Zandi leads the other children. He is always there to help if the pastor needs something done.

3.4 Teacher

Like Poelo, Zandi is an eager, well-behaved and quiet child. He always does his homework, except "*when he didn't have a way forward*." Zandi would then report the problem to the teacher the following morning, she

would help him, and he would then do the work. He never fights with the other children at school, and he tends to make friends with those children who are willing to work.

4. Identified themes and categories

The identified themes and associated subcategories from the information concerning Subject 8 are presented in Table 5.15. The following table presents the child's responses to the external realities listed in Table 5.15.

TABLE 5.15: Identified categories and subcategories (Subject 8)				
	External realities (stressors)	External supports	Inner strengths	Interpersonal, problem-solving skills
Communication mapping, River of life, Happy and sad.	Serious illness of family members Loss of primary caregivers Death Crime <ul style="list-style-type: none"> • Rape Anti social values within the family <ul style="list-style-type: none"> • Domestic violence Frequent geographic moves Substance abuse <ul style="list-style-type: none"> • Caregiver Bullying <ul style="list-style-type: none"> • Children at school Relocation	Supportive relationships <ul style="list-style-type: none"> • Mother • Friends • Teachers • Grandmother • Aunt • Father's sister • Younger brother • Adult role model (Older brother) • Sister • Mamma Teboho • Mistress Supportive environments <ul style="list-style-type: none"> • School • Lebone 	Morality, social values and resistance skills <ul style="list-style-type: none"> • Believes in justice • Judgment • Against harsh corporal punishment of children • Against substance abuse (i.e. smoking) • Cares for others • Values love • Avoids early involvement in serious relationships with the opposite sex Emotional management <ul style="list-style-type: none"> • Able to recognise feelings and control undesirable feelings Achievement motivation <ul style="list-style-type: none"> • Motivated to do well in school Optimism and positive identity <ul style="list-style-type: none"> • Positive view of personal future • Happy disposition Trust <ul style="list-style-type: none"> • Mother • Caregiver at Lebone 	Problem-solving ability <ul style="list-style-type: none"> • Able to find or ask for help Self-efficacy and personal power <ul style="list-style-type: none"> • Belief in ability to exercise control over future and threatening situations Goal-setting, purpose in life and commitment to learning <ul style="list-style-type: none"> • Related to helping others Constructive use of time <ul style="list-style-type: none"> • Playing (Puzzles) • Sports (i.e. Karate, soccer) • Watching television • Creative activities (drawing) Communication
Additional identified subcategories				
Social worker	Separation from siblings Poor care Poverty	Supportive relationships <ul style="list-style-type: none"> • Grandmother's sister • Carer 	Morality and social values <ul style="list-style-type: none"> • Apologises when he has done something wrong 	
Pastor			Ability to lead Responsible Accountable Authoritative	

Additional identified subcategories				
	External realities (stressors)	External supports	Inner strengths	Interpersonal, problem-solving skills
Teachers	Teasing <ul style="list-style-type: none"> Children take his things 		Social values and resistance skills <ul style="list-style-type: none"> Will make friends with children who are willing to work Well behaved Does not fight with children at school 	Commitment to learning <ul style="list-style-type: none"> Does his schoolwork Communication <ul style="list-style-type: none"> Reports difficulties with homework

TABLE 5.16: Responses to stressors or adversities (Subject 8)

External realities (stressors)	Initial thoughts, behaviour, feelings or emotions	Present thoughts, behaviour, feelings or emotions
Serious illness of family members, death, loss of primary caregivers	<p>Seeing his father's corpse had made Zandi feel sad and he recalls that his father always bought him nice things and anything he wanted. Zandi's river flowed down at the time of his parents' death, but the friends he had made at his new school made it easier for him. Zandi was very sad and upset when he heard the news of his mother's death from a neighbour.</p>	<p>Zandi often thinks about his mother and he still remembers exactly what his father looked like the day he went to see him at the mortuary. That had made him feel sad. He sometimes thinks about that day. He remembers that his father had promised to buy him a bicycle, but he never did. Zandi says that his heart still feels sore about having lost his mother, but he does not miss her or think about her. He does love her though. At first, Zandi said that he had no good memories of his mother, but then he recalled, among other things, that his mother had taken good care of him and had bought him anything he wanted.</p>
Crime <ul style="list-style-type: none"> Rape 	<p>Zandi heard the news of his sister's rape from the rapist's wife. He once recognised the rapist in the street. He then went to tell his brother about the man he had seen. Zandi says that he did not feel scared when he saw him that day. He wishes that the man came to him so that he could take him to his brother's house to be beaten. Zandi says that the carer seemed shocked when he told her the story.</p>	<p>Zandi does not know what rape means, but says that rape is bad and that it hurts. He does not know exactly what happened to his sister, but he recalls seeing her, and her underwear full of blood. Zandi often thinks about that day. He feels sad and angry because of what happened, and feels like beating the rapist because he hurt his little sister. He feels that the man did something very wrong. Although Zandi believes that it is not good practice to beat children when they have done something wrong, he believes that it is right to beat adults who have wronged others. He says that the man should be beaten and taken to jail. He is, however, worried about going to jail himself if he beats others. Instead, he says that it would be more appropriate to report to someone. Nevertheless, he thinks that, if that were to happen again, "I can do it both ways. I can beat him first and then report him, or report him and then beat him." He says that if he saw the man again he would not say anything to him, but would tell his grandmother that he had seen him. He says that if he had to see the man now, he would feel afraid. He agrees that he is safe at Lebone and that the man will not come there.</p>
Anti-social values within the family <ul style="list-style-type: none"> Domestic violence 	<p>Zandi found his mother and father fighting when he came home one day. He tried to stop them, but was not successful. Zandi says that he felt scared that day.</p>	

External realities (stressors)	Initial thoughts, behaviour, feelings or emotions	Present thoughts, behaviour, feelings or emotions
Frequent geographic moves	When Zandi, his mother and two sisters had relocated to his uncle's house it had not been an enjoyable experience for him because he did not know the people around . Although it had not been good times for him, he had found it easy to make four new friends with children who lived nearby . Zandi does not know why he was taken to Lebone. Knowing that there are many people at Lebone who care for him at Lebone makes his heart feel better when he had come to Lebone, and caused him not to miss his mother a lot .	Zandi often fights with the other children , and mostly with Bophelo. They would hit each other , and the carer would then have to stop them. Zandi usually stays angry for the entire day, and would not apologise . It would take a long time for him to forgive Bophelo and play with him again . Zandi usually listens to the carer . He does not have a close relationship with his sister and does not play with his younger brother . He often speaks to the other carer . Zandi would often be naughty , especially if he had visited relatives in the township. He would behave like an adult . The carer describes his behaviour as "wild" . He is jealous, aggressive and fights with the younger children . This behaviour usually only lasts for a day or two . Zandi did not take the carer up on her offer to fight with her , instead of picking fights with the younger children and apologised . He promised not to behave in that way again . The pastor, on the other hand, says that Zandi sometimes fights with others , but he views his behaviour as that of a normal child . According to the pastor, Zandi is not a fighter . He is accountable, responsible and loves to organise and reprimand the other children . In this sense he leads the other children . He is always available if something needs to be done . He never fights with the children at school and tends to make friends with those who are willing to work .
Separation from siblings	Zandi was unhappy because he missed his brother and sisters.	
Bullying	Zandi cried when the children at school hit him. He did not know the reason for their behaviour. He told the teacher about what they had done and he had reassured Zandi that he would talk to them.	Zandi told the researcher that it had not hurt his heart when they hit him.
Relationships with the opposite sex		Zandi is not fond of girls, but has no reason for disliking them . Despite this, Zandi wants to have a girlfriend when he is twenty years old and wants to get married .
Substance abuse • Caregiver	Zandi asked the caregiver to stop smoking .	Zandi dislikes smoking . The caregiver did not stop smoking and this bothers Zandi.
Being lost and other difficulties (hypothetically speaking)		At first, Zandi said that he would never get lost. After the researcher rephrased the question, he said that he finds it easy to talk to strangers , and that he would ask people where he could find a phone if he were lost. If there were no phones he would look for transportation to take him to a familiar place or where he was from . Zandi would ask the teacher for help if he experiences difficulty in doing his homework.

The external realities or adversities and stressors listed in Table 5.15, namely the serious illness of family members, loss of primary caregivers, death, crime (rape), anti-social values of family members (domestic violence), separation from siblings, poor care, poverty and frequent geographic moves concern Zandi's home and family environment. However, considering the perpetrator involved in the rape of Zandi's sister and the ensuing effect thereof on Zandi's life, this stressor is also connected to the environment at large, the community.

In counteracting these adversities and stressors Zandi exhibits a number of inner strengths and interpersonal skills such as morality, social values, resistance skills, emotional management, achievement motivation, optimism, positive identity, and trust. According to the Pastor, Zandi also shows the ability to lead, to be responsible, accountable, and authoritative. Morality, social values, and resistance skills are evident as he believes in justice, apologises when he has done something wrong, values love, is against early involvement in serious relationships with the opposite sex, and displays clear judgement about matters such as corporal punishment of children and substance abuse (i.e. smoking). He does not fight with children at school and makes friends with children who are well-behaved and willing to work. His ability to recognise feelings and control undesirable feelings point to emotional management, whereas a positive view of his future and a happy disposition denote optimism and a positive identity. His future aspirations also imply achievement motivation and interpersonal and problem-solving skills such as goal-setting, purpose in life, commitment to learning, self-efficacy, and a sense of personal power. Playing, doing sports, watching television and drawing indicate constructive use of time. Zandi uses communication as a means of dealing with problems.

Supportive relationships within Zandi's family environment are those with his mother whom he trusted most, his grandmother, grandmother's sister, aunt, father's sister, younger brother and two sisters. Zandi's relationship with his older brother appears to be particularly significant in terms of his future. Supportive relationships outside the family are those with his teacher, and friends from school and from the neighbourhood. At Lebone, Zandi also engages in supportive relationships with the other children, the educator and one of the carers whom he also trusts. Supportive environments are Lebone and the schools he has attended.

4. COMPLEMENTARY INFORMATION OBTAINED FROM KEY INFORMANTS

In addition to the data presented in the second part of this chapter, the subsequent sections present the views of the key informants with reference to possible problems or challenges faced by both the children selected for this study and the key informants themselves.

4.1 Social worker

According to the social worker, HIV/AIDS was not discussed among adult family members or with children. Often an HIV-positive mother would keep her status secret. "*She can't even tell the husband. You are the one who's supposed to tell the husband. You are supposed to tell the family at home.*" The mothers would tell the social worker that they are unable to care for the child and need help. They would often ask her to do a home visit, but not to mention HIV. Providing assistance to parents who hide their status and to their children is extremely difficult. The social worker said that in many cases parents also hide their medication from family

members. *“People just hide things and then they never know that those things just kill them again.”* The social worker was of the opinion that the HIV status of an individual is often kept secret because it is a sexually transmitted disease. *“Now, some of other people they thought if you’re HIV-positive it’s just because you were sleeping around. That’s the thing. And then some of the other people, if you are HIV-positive, now they start, they don’t know, they’re afraid and they only thought that you are going to die. That’s the only thing. And then those that are drinking at home, they start swearing at you, everyone knows in the location that you are HIV-positive. That’s the story.”* Community members would often shout and point fingers at HIV-positive individuals, or totally ignore them. The social worker explained that then again, *“people are not the same. Some of the people in the community give support.”*

The social worker felt that the age of the children plays a role in adapting to Lebone. The longer the children lived happily with their parents, in other words the older the children are, the more difficult it is for them to adapt to a new environment where everyone is a stranger. For this reason, it is extremely important to show love towards the children so that they feel secure and cared for. It is also a time-consuming process for the carers to get to know a child, and how to specifically care for him or her.

Concerning the children’s future the social worker said that, according to Lebone’s brochure, they are to stay at Lebone until the age of eighteen. Thereafter, *“were not gonna chase them, it will be their choice, if they want to stay here, we’re prepared. And it will be a good thing too, having them here because they will tell the others, the new, younger ones, what is Lebone. If you stay here you’ll become a person, you’ll become a someone else in the other days.”* The children have the option of going to live with extended family members when they turn eighteen. Therefore, it is suggested that children should keep contact with those family members. If children were to stay at Lebone, the social worker said that they would make sure that the children attain skills. Otherwise, the move from Lebone back into the community would be assisted by the people working at Lebone.

4.2 Caregivers

Carer (A) is very fond of the children and would become very angry at times, because the children are treated differently by the other carers, in particular the night-duty staff. *“If they see the children make the mistake, like playing, making noise, not listening if you tell them don’t play in the house, don’t touch that, its dangerous, things like that. So I see the other ones get angry.”* They shout at, and hit the children. The carer feels that by reprimanding the children in such a way would cause them to become even more naughty and disobedient. Therefore, she tried a gentler approach. Although she sometimes hit them, it was never hard, and she always sat with them and talked to them afterwards, and then hugged and kissed them. *“I try to make it that I’m not angry, I love you, but I try to teach you that I don’t like it when you do this and this. Maybe it’s dangerous when you play with the bottle, and it cuts you here.”* The loss of parents is not only difficult for the children, but having to deal with their grief is also difficult for the carer. She said that she always tries her best to make them happy when they feel sad and cry.

According to the second carer (B), the children often tell her that they miss their parents. She reported no other problems or difficulties regarding the children, and added that most of the children want to follow a profession such as doctor, nurse or psychologist, and seem positive about their future.

4.3 Pastor

According to the pastor, when the children are accommodated at Lebone, they do not exhibit problems in having to adapt to the new environment. They feel welcome and well taken care of. Although extended families provide some of the children with connections within the community at large, *“going back to their extended families [during holidays] to them, was more painful. Some of the children are being used, they will be, these extended families, they will use them or make some grants and then after the grants, they are neglecting them and abusing them. Abuse in the sense of, the way they are being treated, as if they don’t exist.”*

The pastor felt that the children have become more aware of the nature of his role in their lives, and at Lebone. Initially, the children referred to him as “Pappa George,” but now they have *“started catching on,”* and often refer to him as “Pastor.” Because the children from Lebone come from different religious backgrounds, the pastor *“started from scratch”* regarding religious teachings to the children, and he observed that the children are very accepting of what he taught them.

“As a older person,” the pastor noticed that the children at school tease each other, *“but you can also see that the governing of the school have made it clear that every child, doesn’t matter where he comes from, they are all the same.”* According to the pastor, the teachers at school play an important role in creating a culture where children are not teased. Because of the training and support which the children receive at Lebone, they do not respond negatively to the teasing, *“they just ignored those children.”* The pastor said that sometimes the children from school would comment on what they are going to do over weekends with their parents, knowing that the other children do not have parents. *“But now on the side of our children, they become so strong, because those children, things that are happening here is quite different and more important than what is happening at their places. If you see here in Lebone visitors come. There are people that come and spends some time here with the children giving them toys, parties, and things like that. They make them strong. Now other children can see, ‘oh, look they don’t have their parents, but they’ve got something to be proud of.”*

The pastor found it challenging that he is basically the only male figure at Lebone to whom the children can turn and from whom they can learn. He agreed that it is a considerable responsibility. *“What I’ve realised now, every time when they come from the school, I can see that they want me. They want me to be with them, or what they do now, every time, they ask me, can we go with you. They want to go with me, wherever, especially with the boys. The girls will just come, you will see that they just want to share with me, not that they want to go with me.”*

The pastor was concerned about the children's future, because they consider him a father figure in their lives. He said that, in ten years' time, they may leave or he may no longer be at Lebone, and they will no longer share a relationship with him.

4.4 Teachers

The first teacher (A) did not notice that the children perceive the other children from Lebone differently because they are orphans and live at Lebone. All the children are treated equally at the school, and the teachers teach the children not to discriminate against one another. The children are also taught to share with those less fortunate than themselves. According to the teacher, the school receives considerable support from the Department of Education and from the church. The Department of Education initiated a feeding scheme at the school to alleviate hunger, and always sends a psychologist to intervene if any children experience serious learning problems. The church provides clothes to children in need, and holds a quarterly ceremony at the school. The teacher is of the opinion that such ceremonies help to instil morals and good values in the children.

The teacher noticed that learners show an interest in the opposite sex. The boys would touch the girls' buttocks, but the teachers intervene at such times. As a faith-based institution such behaviour is not permitted. The children would talk among themselves about the opposite sex, but the teacher is not aware of any other sexual involvement.

Poverty is the main problem facing the school and learners. Alcohol abuse by parents and neglect of children is also reported. Many foster parents are merely seeking the grants they obtain for taking care of the children, and then neglect them. The teacher observed that children from such homes are quiet and withdrawn or aggressive in class. The school tries to support these children by providing food, clothes and comfort, also in an attempt to show them that they are loved and cared for.

Concerning their future, the teacher said that, if the children were to leave Lebone after school, they would face many problems and their future would not be so bright. He referred especially to problems relating to food and clothing. *"They will not be able to face their future on their own."* He is convinced that the children would never be able to cope with those challenges if they left Lebone before reaching the age of at least 21. Unless Lebone raises funds for the children to attend University, he believes that most of the children would have to be employed at an early age. He thinks that the children would find it difficult to adapt to the community again. *"Some will survive, other's won't survive."* He referred to Lebo, and said that if she could *"find the right education, she will survive. If she can't find the right education, she won't cope. She just needs that support education wise, she's going to be a strong woman. If she can get education, she's going far."* About Dikeledi, he laughed and said that she is a naughty girl, and *"she was going to trip on her way. Just coming to her health, she's untidy; she's not going to cope. Its going to be much difficult, she's going to be vulnerable, really. It's something that she has to learn now, she can't always be protected."* The teacher said that if Kagiso were to leave Lebone after school, he would not further his studies. According to the teacher,

Kagiso needs much support and guidance from Lebone. The teacher said that even though some of the children from Lebone could stay with extended family members after school, many of these family members abuse alcohol.

According to the second teacher (B), the children from Lebone keep to themselves, especially during breaks. They always sit and eat together. Children in the school tease each other, but this is not specifically directed at children from Lebone. The teacher did, however, say that the other children perceive the children from Lebone as different because they are orphans. The teacher thought that their perception causes a barrier between them and the children from Lebone. She observed that the other children have an attitude of being better than the children from Lebone. The teacher was uncertain about their future. She said that if they stay at Lebone they will be fine. She thought that if they are able to get bursaries to study at University, *“they will cope with the situation in the community.”*

The third teacher (C) did not think that the children at the school perceive the children from Lebone as different. *“They liked these children very much,”* and they all play together. She argued that this is due to the fact that even though some of the children are in Lebone, there were many children from the community who also lost their parents, but lived with extended family members, and that all the children are treated equally. *“Children understand, and also they feel shame for those who have lost their parents.”* According to this teacher, there was no teasing among learners. The teacher foresaw no problem regarding the children's future if they were able to stay at Lebone. She felt that it would help if Lebone could raise funds for the children to continue their education after school. The fact that the children are taught values and *“attitudes”* at Lebone plays an important role in their lives. She felt that this would also shape their future.

5. SUMMARY

This chapter organised, systematised and analysed the information gathered during the empirical investigation according to each subject or case. The key themes and associated subcategories identified from the information concerning a case or subject were arranged according to an analytical framework, comprising of four main categories, namely (1) external realities, (2) external supports, (3) inner strengths, and (4) interpersonal, problem-solving skills. These categories constitute the four main components that contribute to the establishment, sustainment and development of psychological resilience. Subsequently, the children's responses linked to the first category (i.e. external realities) were presented according to the individual cases. Additionally, complementary data obtained from the key informants were presented, as communicated by each respondent (i.e. the social worker, two caregivers, the pastor and the three teachers). Chapter 6 further analyses, summarises and discusses this information according to the four categories of the analytical framework.

Chapter 6

DISCUSSION OF THE RESULTS AND CONCLUSIONS

1. INTRODUCTION

Chapter 5 provided a descriptive overview of the results for all eight children in the research group according to each case or subject. For an account of the factors that play an important role in the establishment and sustainment of psychological resilience (also cf. Table 2.4; p. 41) in pre-adolescent HIV/AIDS-affected children, the results for all eight children are summarised and discussed according to the four main categories of the analytical framework (cf. p. 89), namely (1) external realities (stressors and challenges); (2) external supports or support networks that promote resilience; (3) inner strengths that develop over time and sustain children who are dealing with adversity, and (4) interpersonal, problem-solving skills that deal with the actual adversity. The last three categories refer to protective factors that buffer against the negative impact of adversity and/or risk on children's lives (cf. 3.3, p. 13-4; Tables 2.3 and 2.4; p. 20; 1.5, p. 202).

1.1 External realities: stressors and challenges

The results for all eight children for this category are summarised, followed by a discussion of these results.

1.1.1 Summary of results

Table 6.1 provides a summary of the external realities as communicated by the children and/or key informants selected for this study. These realities are linked to four subcategories or contexts that intimately shape these children's lives, namely, (1) their family, (2) their community or neighbourhood, (3) their school, and (4) Lebone. The responses listed in Table 6.1 indicate the variables that function as stressors and challenges, initiating risk and resilience processes. These variables are considered adversities (stressors) as they correlate with the adversities listed by various authors (cf. 4.1.1, p. 16-7), the major life events or episodic, traumatic events measured by the *Life Events Checklist* (Work, Cowen., Parker & Wyman, 1990), and the stressors measured by the *Sources of Stress Inventory* (Chandler, 1981). As suggested by Naglieri & LeBuffe (2005: 108), daily hassles, for instance poor quality childcare and teasing, were included to gain a more complete picture of exposure to risk and adversity.

TABLE 6.1: A summary of the external realities (stressors and challenges) communicated by the children and/or key informants

Subcategories	Number of Subjects	Percentage	Subjects concerned	Gender	Responses from children and/or key informants
Family <i>Total of (61) responses</i>	8/8	100%	1, 2, 3, 4, 5, 6, 7, 8	4 Female 4 Male	Experienced illness, death and loss of primary caregivers.
	6/8	75%	3, 4, 5, 6, 7, 8	3 Female 3 Male	Received poor care.
	5/8	62.5%	1, 2, 4, 7, 8	3 Female 2 Male	Been exposed to anti-social values (violence or conflict) of family members.
	5/8	62.5%	3, 4, 5, 7, 8	3 Female 2 Male	Been separated from their siblings.
	5/8	62.5%	1, 2, 5, 7, 8	2 Female 3 Male	Attended the funerals of loved ones.
	4/8	50%	1, 3, 5, 8	3 Female 1 Male	Experienced extreme poverty.
	4/8	50%	1, 4, 6, 7	2 Female 2 Male	Suffered neglect.
	3/8	37.5%	2, 4, 5	2 Female 1 Male	Commented on the loss of family members other than primary caregivers.
	3/8	37.5%	1, 5, 6	2 Female 1 Male	Separated from their parent (i.e. their parent was alive when they were accommodated at Lebone).
	2/8	25%	1, 4	2 Female	Experienced unemployment of primary caregiver(s).
	2/8	25%	1, 4	1 Female 1 Male	Reported on corporal punishment.
	2/8	25%	2, 7	2 Male	Seemingly suffered abuse.
	2/8	25%	2, 4	1 Female 1 Male	Grown up in a single-parent household.
	2/8	25%	5, 7	1 Female 1 Male	Experienced rejection from family members.
	2/8	25%	1, 7	1 Female 1 Male	Experienced abandonment.
	2/8	25%	1, 7	1 Female 1 Male	Been exposed to alcohol abuse by a relative.
	1/8	12.5%	4	1 Female	Faced separation from a primary caregiver who was an extended family member.
	1/8	12.5%	6	1 Male	Faced the illness of siblings.
1/8	12.5%	8	1 Male	Commented on frequent geographic moves.	
1/8	12.5%	5	1 Female	Been exposed to poor family relations.	
1/8	12.5%	1	1 Female	Family dysfunction due to alcohol abuse.	
Community/ Neighbourhood <i>Total of (25) responses</i>	8/8	100%	1, 2, 3, 4, 5, 6, 7, 8	4 Female 4 Male	Been relocated to a community care facility.
	5/8	62.5%	2, 3, 6, 7, 8	1 Female 4 Male	Relocated to extended family members.
	4/8	50%	1, 4, 5, 8	3 Female 1 Male	Commented on crime (kidnapping, theft, rape, "tsotsis").
	3/8	37.5%	2, 5, 7	1 Female 2 Male	Experienced negative gender-based relations.
	2/8	25%	1, 4	2 Female	Commented on violence within their community.
	1/8	12.5%	5	1 Female	Lived in a hazardous neighbourhood.
	1/8	12.5%	4	1 Female	Commented on suicide.
	1/8	12.5%	7	1 Male	Received poor care from members within the community.
School <i>Total of (14) responses</i>	6/8	75%	1, 2, 3, 6, 7, 8	3 Female 2 Male	Experienced or had experienced learning difficulties.
	4/8	50%	3, 4, 7, 8	2 Female 2 Male	Been teased by children.
	2/8	25%	1, 7	1 Female 1 Male	Experienced school failure.
	2/8	25%	4, 6	1 Female 1 Male	Experienced restricted school attendance.
	1/8	12.5%	8	1 Male	Been bullied by children at school.
Lebone <i>Total of (3) responses</i>	1/8	12.5%	8	1 Male	Commented on substance abuse by the caregiver.
	1/8	12.5%	4	1 Female	Experienced poor health.
	1/8	12.5%	1	1 Female	Commented on the loss of friends.

The significance of each subcategory specified in Table 6.1 is calculated by adding the number of subjects linked to the responses in a particular subcategory. The pie diagram below illustrates the respective subcategories in terms of their significance.

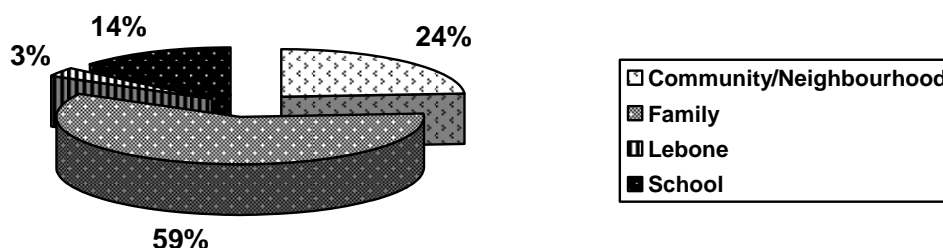

Diagram 6.1: Significance of external realities according to four subcategories, as communicated by the children and/or key informants.

Adversities related to these children's families appear to be the most significant source of stress in their lives. This subcategory represents 59% of the responses for all four categories, followed by the community or neighbourhood, representing 24%, and the school, 14%. In relation to these three subcategories, Lebone barely seems significant as this subcategory constitutes only 3% of the response for all four categories. Additional or complementary information provided by the key informants regarding external realities related to these four categories is summarised in Table 6.2. This includes responses associated with challenges or adversities faced by the children and, by implication, their caregivers and educators.

Subcategories	Number of respondents	Percentage	Respondent	Responses from key informants
Community/Neighbourhood <i>Total of (8) responses</i>	1/7	14.3%	Social worker	Stigma (due to the fact that AIDS is a sexually transmitted disease)..
	1/7	14.3%	Social worker	Lack of support from community members.
	1/7	14.3%	Social worker	Verbal abuse by community members towards HIV-infected individuals.
	1/7	14.3%	Social worker	Culture of silence surrounding AIDS (AIDS was often not discussed among family members or with children).
	1/7	14.3%	Teacher A	Poverty.
	1/7	14.3%	Teacher A	Children from Lebone will find it hard to adapt to living within the community.
	1/7	14.3%	Teacher A	Unless Lebone raises funds for the children to attend University, most of the children will have to be employed at an early age.
	1/7	14.3%	Teacher A	The children would not be able to cope with the transition back into the community before the age of 21.
Family <i>Total of (6) responses</i>	1/7	14.3%	Social worker	Providing assistance to children from homes where the parent's HIV status was kept secret is difficult.
	1/7	14.3%	Pastor	Although extended families provide children with connections in the community at large, visits to these family members proved to be painful for the children.
	1/7	14.3%	Pastor	Neglect, abuse, exploitation of children by extended family members
	1/7	14.3%	Teacher A	Even though some of the children from Lebone could stay with extended family members after school, many of these family members abuse alcohol.
	1/7	14.3%	Teacher A	Neglect of children by foster parents.
	1/7	14.3%	Teacher A	Alcohol abuse by parents.

Subcategories	Number of respondents	Percentage	Respondent	Responses from key informants
Lebone <i>Total of (5) responses</i>	1/7	14.3%	Social worker	Age determined quality of adaptation. Older children who lived happily with their families find it more difficult to adapt to a new environment.
	1/7	14.3%	Caregiver A	Having to deal with the children's grief is difficult.
	1/7	14.3%	Pastor	As the only "father figure" for the children, the Pastor considers his role at Lebone an overwhelming responsibility .
	1/7	14.3%	Caregiver A	Psychological maltreatment of children by some of the carers from Lebone as well as extended family members.
	1/7	14.3%	Social worker	Getting to know each child and learning how to take care of him or her is a time-consuming process .
School <i>Total of (4) responses</i>	2/7	28.6%	Pastor Teacher B	The children from Lebone are teased by other children at school . The teacher feels that teasing among learners in the school is not always specifically directed at the children from Lebone.
	2/7	28.6%	Teacher A Pastor	Other children perceive the children from Lebone differently because they are orphans and live at Lebone. Other children have an attitude of being better than the children from Lebone.

The relative importance of the four subcategories listed in Table 6.2 is graphically illustrated as follows:

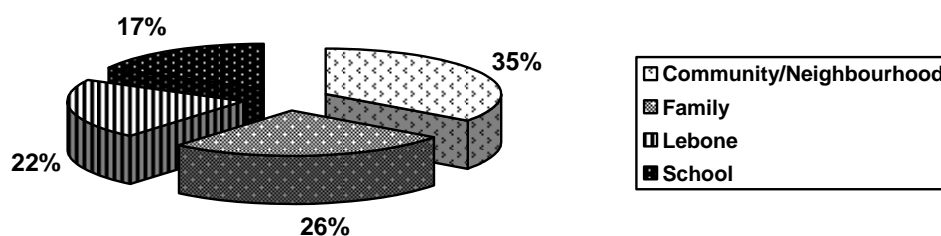

Diagram 6.2: Significance of external realities according to four subcategories, as communicated by the key informants

In contrast with Diagram 6.1, this diagram suggests that the community or neighbourhood is the most significant source of adversities and challenges for the children. The subcategories relating to the children's families and Lebone appear to be of moderate significance and the school is indicated as least significant as the responses in this category represent only 17% of the responses for all four categories.

The children's initial responses (i.e. their emotions or feelings, behaviour and thoughts, at the time a particular adversity took place, for instance, at the time of a parent's death or illness) to the common external realities or stressors (cf. the last column of Table 6.1), correlated with the four subcategories in Diagram 6.2, are summarised in Table 6.3.

TABLE 6.3: A summary of initial responses to common external realities (stressors and challenges)

Subcategories	Number of subjects	Percentage	Subjects concerned	Gender	Responses from children and/or key informants
Death and funerals <i>Total of (31) responses</i>	8/8	100%	1, 2, 4, 5, 6, 7, 8	4 Female 4 Male	Report feeling sad .
	6/8	75%	1, 2, 4, 5, 6, 7	3 Female 3 Male	Say that they cried .
	4/8	50%	2, 4, 5, 8	2 Female 2 Male	Recall fond memories of their diseased parents.
	2/8	25%	1, 2	1 Female 1 Male	Report feeling scared .
	2/8	25%	4, 8	1 Female 1 Male	Turn to friends for comfort.
	2/8	25%	5, 7	1 Female 1 Male	Told members of their family that their parent would not wake up.
	1/8	12,5%	1	1 Female	Says she cried at her friends' burial.
	1/8	12,5%	2	1 Male	Feels afraid .
	1/8	12,5%	3	1 Female	Feels quiet at times and then, wants to be left alone .
	1/8	12,5%	2	1 Male	Thinks of the cross .
	1/8	12,5%	6	1 Male	Says his heart feels sore .
	1/8	12,5%	7	1 Male	Thinks that he will not have a nice life again .
	1/8	12,5%	2	1 Male	Was told , presumably by family members, not to cry because "God has taken him."
	1/8	12,5%	4	1 Female	Speaks to adults (staff members at Lebone).
1/8	12,5%	5	1 Female	Did not believe a family member when she lied about her mother's death .	
Violence, crime and anti-social values of family members <i>Total of (27) responses</i>	4/8	37.5%	1, 2, 4, 8	3 Female 1 Male	Feel sad and upset .
	3/8	37.5%	1, 7, 8	1 Female 2 Male	Fight back when others attempt to fight with them.
	3/8	37.5%	1, 4, 8	2 Female 1 Male	Feel scared .
	2/8	25%	1, 2	1 Female 1 Male	Report fights to others.
	1/8	12,5%	8	1 Male	Feels angry .
	1/8	12,5%	1	1 Female	Cries when others fight.
	1/8	12,5%	8	1 Male	Tries to stop the fighting .
	1/8	12,5%	1	1 Female	Communicates her views on the matter (fighting) to others.
	1/8	12,5%	1	1 Female	Stops playing when someone wants to fight.
	1/8	12,5%	1	1 Female	Walks away if there is no victory.
	1/8	12,5%	1	1 Female	Goes to find someone when alone at home.
	1/8	12,5%	2	1 Male	Thinks that the beating he received was unfair .
	1/8	12,5%	2	1 Male	Wants to report beating to the police, but never did.
	1/8	12,5%	2	1 Male	Never fights with other children.
	1/8	12,5%	5	1 Female	Does not believe lies of family member.
	1/8	12,5%	4	1 Female	Turns to a parent for help when beaten at school.
	1/8	12,5%	8	1 Male	Told a family member that he saw the criminal.
1/8	12,5%	8	1 Male	Did not feel afraid when he saw the criminal.	
1/8	12,5%	8	1 Male	Wishes that he could have taken the criminal to his brother's house to be beaten (punished).	
Serious illness of primary caregiver(s) <i>Total of (23) responses</i>	3/8	37.5%	3, 5, 4, 7	2 Female 1 Male	Report feeling sad .
	2/8	25%	4, 5	2 Female	Feel afraid .
	2/8	25%	5, 6	1 Female 1 Male	Take care of their parents .
	2/8	25%	5, 6	1 Female 1 Male	Dropped out of school .
	2/8	25%	4, 7	1 Female 1 Male	Turn to family members for comfort.
	1/8	12,5%	1	1 Female	Wets her bed every night , hides the wet blankets and underwear , and feels sad and embarrassed when that happens. When asked about what she had done, she cried and was very apologetic .
	1/8	12,5%	4	1 Female	Feels unhappy .
	1/8	12,5%	5	1 Female	Feels sad to leave her father, but happy to relocate to Lebone.
	1/8	12,5%	1	1 Female	Accepts the situation .
	1/8	12,5%	4	1 Female	Thinks that her friends would laugh at her if they heard of her mother's illness.
	1/8	12,5%	4	1 Female	Is afraid to tell her friends .
	1/8	12,5%	5	1 Female	Thought that her father would die soon .
	1/8	12,5%	5	1 Female	Prays .
	1/8	12,5%	5	1 Female	Told her father that she loves him .

Subcategories	Number of subjects	Percentage	Subjects concerned	Gender	Responses from children and/or key informants
Serious illness of primary caregiver(s)	1/8	12,5%	3	1 Female	Cries.
	1/8	12,5%	5	1 Female	Finds the situation (caring for an ill parent alone) very difficult.
	1/8	12,5%	5	1 Female	Takes responsibility for household livelihood.
School failure, learning difficulties <i>Total of (8) responses</i>	2/8	25%	1, 7	1 Female 1 Male	Cry.
	2/8	25%	1, 2	1 Female 1 Male	Learn harder.
	1/8	12,5%	7	1 Male	Hides in the bathroom.
	1/8	12,5%	7	1 Male	Does not want to listen when told that failing a grade is wrong.
	1/8	12,5%	6	1 Male	Speaks to a carer at Lebone about difficulties he experiences at school.
Witnessing vehicle accidents <i>Total of (7) responses</i>	1/8	12,5%	5	1 Female	Feels scared and worried.
	1/8	12,5%	5	1 Female	Thought that her father might have been in the accident.
	1/8	12,5%	5	1 Female	Felt happy when she realised that her father was not in the taxi.
	1/8	12,5%	5	1 Female	Had hope for the people who were injured because she thought that nurses could help them.
	1/8	12,5%	5	1 Female	Ran home to tell the people in the house what had happened.
	1/8	12,5%	2	1 Male	Felt sad.
	1/8	12,5%	2	1 Male	Thought that the driver was killed.
Teasing <i>Total of (5) responses</i>	1/8	12,5%	3	1 Female	Cried and reported the incident to a teacher.
	1/8	12,5%	4	1 Female	Thought that her eyes were brown because she had problem eyes.
	1/8	12,5%	4	1 Female	Despite the teasing, she enjoys going to school.
	1/8	12,5%	7	1 Male	Hits children who tease him with the fist.
Poor care and neglect <i>Total of (4) responses</i>	1/8	12,5%	7	1 Male	Tries to handle incidents (teasing) independently.
	2/8	25%	6, 7	2 Male	Report poor care and neglect to staff at Lebone.
	1/8	12,5%	1	1 Female	Accepted the situation.
Negative gender based relations <i>Total of (2) responses</i>	1/8	12,5%	5	1 Female	"Just looked ugly" at boys who whistled at her.
	1/8	12,5%	2	1 Male	Feels that he was falsely accused by "mamas."

Table 6.4 summarises the children's present responses (i.e. their emotions or feelings, behaviour and thoughts at the time of the interviews) to the common external realities or stressors, as communicated by the children and/or key informants that relate to the four subcategories listed in Table 6.1.

Subcategories	Number of subjects	Percentage	Subjects concerned	Gender	Responses from children and/or key informants
Death and funerals <i>Total of (56) responses</i>	8/8	100%	1, 2, 3, 4, 5, 7, 8	4 Female 4 Male	Feel sad.
	7/8	87,5%	1, 3, 4, 5, 6, 7, 8	4 Female 3 Male	Have fond memories of their parents.
	5/8	62,5%	3, 4, 5, 7, 8	3 Female 2 Male	Think about their parents often.
	4/8	50%	1, 3, 4, 5	4 Female	Said that they miss the loved ones they had lost.
	3/8	37,5%	3, 5, 7	2 Female 1 Male	Cry.
	3/8	37,5%	4, 5, 8	2 Female 1 Male	Feel hurt (or sore).
	2/8	25%	2, 4	2 Female	Cry often.
	2/8	25%	2, 5	2 Female	Said that they speak to staff at Lebone.

Subcategories	Number of subjects	Percentage	Subjects concerned	Gender	Responses from children and/or key informants
Death and funerals	1/8	12,5%	1	1 Female	Thinks of how much she loves her friend.
	1/8	12,5%	1	1 Female	Wets the bed occasionally.
	1/8	12,5%	8	1 Male	Does not miss or think about his mother.
	1/8	12,5%	1	1 Female	Misses wearing her own clothes which her parents bought for her.
	1/8	12,5%	4	1 Female	Thinks of how much she loves her sister.
	1/8	12,5%	3	1 Female	Said that it is difficult living without a parent(s).
	1/8	12,5%	2	1 Male	Death and funerals make him feel scared.
	1/8	12,5%	2	1 Male	Does not run around and play a lot with the other children.
	1/8	12,5%	8	1 Male	Recalls that his father made promises which he was unable to keep.
	1/8	12,5%	2	1 Male	Is usually quiet.
	1/8	12,5%	8	1 Male	Said that he loves his mother.
	1/8	12,5%	4	1 Female	Often becomes "down" and emotional.
	1/8	12,5%	5	1 Female	Plays with friends - this makes the sadness subside.
	1/8	12,5%	6	1 Male	Feels unhappy when he thinks of his mother.
	1/8	12,5%	5	1 Female	Considers the staff at Lebone as the parents in her life.
	1/8	12,5%	5	1 Female	Believes that there are many people around her who love and care for her; that makes living without parents easier.
	1/8	12,5%	3	1 Female	Thoughts of the care received at Lebone make living without her mother easier.
	1/8	12,5%	5	1 Female	Believes that thinking about the good memories she had of her parents will help her through sad times.
	1/8	12,5%	5	1 Female	Faith and a belief in God contribute to a sense of purpose in life.
	1/8	12,5%	5	1 Female	Considers her uncle as her father.
1/8	12,5%	1	1 Female	Considers her mother's boyfriend as her father.	
1/8	12,5%	7	1 Female	Does not want to have children because he is concerned about what would happen to them if he passed away.	
Relocation (Lebone) <i>Total of (53) responses</i>	7/8	87,5%	1, 3, 4, 5, 6, 7, 8	4 Female 3 Male	Commented positively about living at Lebone.
	3/8	37,5%	2, 6, 7	3 Male	Are quiet children.
	3/8	37,5%	2, 7, 8	3 Male	Enjoy being in charge of the other children.
	2/8	25%	4, 6	1 Male	Often withdraws and looks upset , and does not want to play.
	2/8	25%	7, 8	2 Male	Like to be the leader.
	1/8	12,5%	7	1 Male	Does not know if he will visit his brother again.
	1/8	12,5%	7	1 Male	Loves his brother and misses him very much.
	1/8	12,5%	7	1 Male	Cries when some of the children go home for the school holidays.
	1/8	12,5%	7	1 Male	Believes that the people at Lebone do good and important things for them.
	1/8	12,5%	7	1 Male	Only listens to some people at Lebone if he is disciplined.
	1/8	12,5%	7	1 Male	Becomes angry at some people at Lebone who discipline him.
	1/8	12,5%	7	1 Male	Is jealous, lies often, and craves attention.
	1/8	12,5%	7	1 Male	Described as a happy child most of the time.
	1/8	12,5%	7	1 Male	Only wants to be praised and not told that he is wrong.
	1/8	12,5%	7	1 Male	Respects and appreciates the carer.
	1/8	12,5%	7	1 Male	Cries when the other children receive something and not him.
	1/8	12,5%	7	1 Male	Prefers to play with the older children and the babies.
	1/8	12,5%	2	1 Male	Plays cars with the younger children. He pushes the cars across the sand in dreamlike manner.
	1/8	12,5%	2	1 Male	Described as shy.
	1/8	12,5%	2	1 Male	Described as lazy.
	1/8	12,5%	8	1 Male	Feels safe at Lebone.
	1/8	12,5%	1	1 Female	Does not wash herself properly.
	1/8	12,5%	5	1 Female	Believes that the people who love and care about her will help her through difficult times.
	1/8	12,5%	5	1 Female	Exhibits no behaviour problems.
	1/8	12,5%	5	1 Female	Has become very reserved.
	1/8	12,5%	3	1 Female	Wishes to visit her friend whom she misses very much in Botshabelo.
	1/8	12,5%	6	1 Male	Wants to stay at Lebone.
	1/8	12,5%	6	1 Male	Described as a normal child.
	1/8	12,5%	6	1 Male	Responded that he does not know why he is having nightmares.
	1/8	12,5%	6	1 Male	Said that he is tired when he is upset.
	1/8	12,5%	4	1 Female	Often cries, does not eat or talk and plays with the babies in the house at Lebone when she is upset.
	1/8	12,5%	6	1 Male	Does not laugh a lot with the other children.
	1/8	12,5%	4	1 Female	Noisily plays and runs around.
1/8	12,5%	4	1 Female	Experiences physical health problems.	
1/8	12,5%	8	1 Male	Fights with the other children of his age.	
1/8	12,5%	8	1 Male	Remains angry for a long time after a fight and does not apologise.	
1/8	12,5%	8	1 Male	Listens and apologises to the carers when disciplined.	
1/8	12,5%	8	1 Male	Does not have a close relationship with his siblings.	

Subcategories	Number of subjects	Percentage	Subjects concerned	Gender	Responses from children and/or key informants
Relocation (Lebone)	1/8	12,5%	8	1 Male	Often speaks to one of the carers.
	1/8	12,5%	8	1 Male	After his visits to the location, he is aggressive, jealous and fights with the younger children.
	1/8	12,5%	8	1 Male	Always helpful.
Violence, crime and anti-social values of family members <i>Total of (34) responses</i>	1/8	12,5%	7	1 Male	Wants to become a soldier and use his gun to prevent crime.
	1/8	12,5%	2	1 Male	Does not want to see his uncle again and does not want him to visit Lebone.
	1/8	12,5%	1	1 Female	Is afraid of "tsotsis."
	1/8	12,5%	1	1 Female	Shouts and screams for help if confronted by "tsotsis."
	1/8	12,5%	1	1 Female	Makes her sad to be involved in a fight.
	1/8	12,5%	7	1 Male	Looked sad when she told the researcher about the fighting (story) she had heard about.
	1/8	12,5%	4	1 Female	Agrees that instead of fighting, people should deal with anger by talking to one another.
	1/8	12,5%	4	1 Female	Believes that people should ask for forgiveness when they have done something wrong.
	1/8	12,5%	4	1 Female	Believes Jesus Christ became angry and unhappy with people who fought.
	1/8	12,5%	4	1 Female	If Jesus were present He would tell them to stop fighting and swearing because it's a bad thing.
	1/8	12,5%	4	1 Female	Believes Jesus was strong, but would not fight back because He is a child of God.
	1/8	12,5%	4	1 Female	The thought of Jesus makes her feel happy and safe.
	1/8	12,5%	4	1 Female	A necklace made her feel secure as this reminded her of God's presence in her life.
	1/8	12,5%	4	1 Female	Thinks that people will not be happy if she kills herself.
	1/8	12,5%	4	1 Female	Feels that it would not be right if she hurt herself (commit suicide) like the people whose story she had told.
	1/8	12,5%	4	1 Female	Scared of being kidnapped if she perhaps got lost.
	1/8	12,5%	4	1 Female	If she were kidnapped she would cry and try to phone the police.
	1/8	12,5%	4	1 Female	It is better to talk about problems or feelings than to commit suicide or hurt herself.
	1/8	12,5%	4	1 Female	Rocked back and forth and pulled the hood of her sweater over her head when she spoke of the corporal punishment she had received.
	1/8	12,5%	4	1 Female	First, she said that the hiding the teacher gave really hurt and then confessed that it had not really hurt.
	1/8	12,5%	8	1 Male	Does not know what rape means.
	1/8	12,5%	8	1 Male	Believes that rape is bad and hurts.
	1/8	12,5%	8	1 Male	Often thinks about the day his sister was raped.
	1/8	12,5%	8	1 Male	Feels sad about what happened to his sister.
	1/8	12,5%	8	1 Male	Feels angry that his sister was raped.
	1/8	12,5%	8	1 Male	Wants to beat the rapist.
1/8	12,5%	8	1 Male	Feels that the rapist did something very wrong.	
1/8	12,5%	8	1 Male	Believes that it is not right to beat children who have done something wrong.	
1/8	12,5%	8	1 Male	It is right to beat adults who have wronged others.	
1/8	12,5%	8	1 Male	Would tell his grandmother if he saw the rapist again. He would say nothing to the rapist.	
1/8	12,5%	8	1 Male	Believes that the rapist should be beaten and taken to jail.	
1/8	12,5%	8	1 Male	Worried about going to jail if he beat someone.	
1/8	12,5%	8	1 Male	Believes it is best to report crime to the police.	
1/8	12,5%	8	1 Male	He would feel afraid if he saw the rapist.	
School failure, learning difficulties	1/8	12,5%	2	1 Male	Would try again and study harder.
	1/8	12,5%	1	1 Female	Is a little mischievous at times.
	1/8	12,5%	1	1 Female	Listens and does her work when disciplined.
	1/8	12,5%	3	1 Female	Does not speak to the teacher about her troubles.
School failure, learning difficulties <i>Total of (7) responses</i>	1/8	12,5%	3	1 Female	Lacks concentration, does not always listen and withdraws.
	1/8	12,5%	3	1 Female	Neglects to do homework.
Negative gender based relations <i>Total of (3) responses</i>	1/8	12,5%	7	1 Male	Feels embarrassed by the girls' mannerisms.
	1/8	12,5%	5	1 Female	Believes that boys do and say "funny stuff" to girls.
	1/8	12,5%	5, 7	1 Female 1 Male	Dislikes peers of the opposite sex.

Subcategories	Number of subjects	Percentage	Subjects concerned	Gender	Responses from children and/or key informants
Serious illness of family members <i>Total of (3) responses</i>	1/8	12,5%	6	1 Male	Loves his brothers very much.
	1/8	12,5%	6	1 Male	Lies on the carpet and looks at his brothers .
	1/8	12,5%	5	1 Female	Thinks that her father owed her because she took care of him when he was ill.
Witnessing vehicle accidents <i>Total of (2) responses</i>	1/8	12,5%	7	1 Male	Feels sad about what had happened.
	1/8	12,5%	5	1 Female	Wants to become a nurse and care for people who were involved in accidents .
Teasing <i>Total of (1) responses</i>	1/8	12,5%	4	1 Female	Looked sad when she told about being teased by friends.
Poor care and neglect <i>Total of (1) responses</i>	1/8	12,5%	4	1 Female	Talking about the story of a child who had been left alone made her feel angry .

The children's responses to the afore-mentioned adversities (cf. the first column of Tables 6.3. and 6.4) not only capture their feelings or emotions, behaviours and thoughts, but also indirectly reveal their coping strategies. These strategies mainly involve taking on a variety of adult responsibilities such as looking after siblings or other younger children, caring for ill and dying parents and doing household chores; dropping out of school; taking responsibility for the household livelihood; turning to fellow youths, family members and other adults such as teachers and staff members from Lebone for comfort and support concerning personal and private matters. As discussed in the literature review (cf. 3.1, p. 50-1), these responses are common strategies employed by HIV/AIDS-affected children to survive and cope in their environment.

For the purposes of this study, and with future intervention or prevention programmes in mind, the researcher limits the subsequent discussion(s) to the three most significant subcategories related to each main category. The responses (adversities) corresponding with the three most significant subcategories in Tables 6.1, 6.2, 6.3 and 6.4 will now be discussed. This discussion focuses on the most prevalent adversities among the children in the research group, in other words, adversities that concern three or more children, within each subcategory, namely:

Table 6.1: The first subcategory, the family, includes illness, death and loss of primary caregivers and other family members, poor care, anti-social values of family members, separation from siblings and primary caregivers, funerals, extreme poverty, and neglect. The second subcategory, the community/neighbourhood, covers: being relocated to a community care facility and/or extended family members, crime and negative gender based relations. The third subcategory, the school, includes learning difficulties and teasing. **Table 6.2:** focuses on the subcategories concerning the community or neighbourhood, the family and Lebone. **Table 6.3:** The first subcategory, death and funerals, covers responses such as feeling sad, crying and recalling fond memories of diseased parents. The second subcategory (i.e. violence, crime and anti-social

values of family members) includes feeling sad and upset, fighting back when other attempt to fight with them and feeling scared. The third subcategory (i.e. serious illness of primary caregivers) involves feeling sad. **Table 6.4:** The first subcategory, death and funerals, covers responses such as feeling sad, having fond memories of parents, having thoughts about their diseased parents frequently, missing loved ones they had lost, crying and feeling hurt. The second subcategory, namely relocation, focuses on responses such as commenting positively about living at Lebone, being quiet and enjoying being in charge of other children. Although the third subcategory (i.e. violence, crime and anti-social values of family members) is significant in terms of the number of responses associated with this subcategory, it does not include responses that concern three or more children. Therefore, although this subcategory is included in the discussion there are no references to specific responses concerning this subcategory of Table 6.4.

1.1.2 Discussion of the results

According to Table 6.1, every child in the research group has been exposed to at least eight or more adversities. Research indicates that exposure to four or more adversities in childhood is associated with four- to twelve-fold increase in risk for alcoholism, drug abuse, depression and alcohol abuse in adulthood. Exposure to eight or more adversities increases the risk of negative mental outcomes by 5.7 times, compared to children who have been exposed to three or less adversities (Sandler *et al.*, 2005: 337). Therefore, bearing this in mind, all the children in the research group are considered at great risk for poor developmental outcomes.

Within the subcategory concerning the children's families (cf Table 6.1), illness, death and loss of primary caregivers seem to be essential adversities concerning all eight children. The children's initial responses to these adversities essentially include feelings of bereavement such as sadness, crying, hurt and recalling fond memories of those they had lost. According to Mallmann (2003: 17) and Williams (2002: 206), these responses (thoughts and feelings) are natural for children who have lost a parent, and are referred to as "grieving." Dealing with grief is critical. If children's needs to express their reactions to grief and mourning are inhibited, extreme reactions such as complicated grief or prolonged emotional numbing, severe depression, anti-social behaviour and physical illness may arise and impede development (Mallmann, 2003: 131; Williams, 2002: 206). Responses that characterise these severe reactions in children include withdrawal, eating disturbances, tiredness, difficulty in expressing reactions to grief, and suicidal or other self-destructive thoughts (Mallmann, 2003: 131-3). Although all these responses were exhibited by the children in the research group, most of these responses changed in intensity and did not seem to last for a long time. Therefore, these responses are not necessarily classified as extreme reactions requiring specialised help. They may relate to adversities such as death and loss of loved ones and may indicate that the grief process has not been dealt with adequately.

Also noteworthy, with reference to this category, is the fact that six children had experienced poor care. Anti-social values (violence or conflict) of family members, the funerals of loved ones and separation from siblings seem significant as seven of the children had been exposed to at least one or more of these stressors.

Adversities of moderate significance, indicated by the additional information provided by the key informants, include extreme poverty and neglect. According to Schorr (1988: xxii), poverty is one of the most devastating risk factors as “virtually all other risk factors [including, for instance, neglect or poor care] that make rotten outcomes more likely are also found disproportionately among poor children.” Factors such as school failure, violent crime, and school-aged childbearing have frequently been correlated with poverty (Mastropieri & Scruggs, 2000: 114-6; Schorr, 1988: xxii). Therefore, as suggested in the literature review, poverty cannot be understood in terms of family income only. The threat and potentially devastating impact of poverty not only encompasses deprivation of resources, capabilities, choices, security and power necessary for the enjoyment of an adequate standard of living, but also extends across the physical, emotional and intellectual components of these children’s development and impedes many of their rights such as the right to survival, health and nutrition, education and protection from harm (Bellamy, 2004: 15-6; Felner, 2005: 125; Monson *et al.*, 2006: 10, 21).

All the children in the research group had experienced and commented on some form of violence associated with their families or communities. This too has long been associated with poverty (Williams, 2002: 197). For these children actual violence involved witnessing and experiencing violence in the home as an assault on a person from their family (rape or fighting between parents that resulted in death) or by a family member on themselves or others in the community; witnessing or hearing about and being aware of random violence in their communities (rape, suicide, or other violent crimes); and witnessing and experiencing incidents of violence among peers and other children. Growing up in violent conditions is often accompanied by a cluster of feelings including depression, guilt, hopelessness, lowered self-esteem, and a sense of danger, or worries about injuries and death (Das Eiden, 1999: 1300; Greene, Taylor, Evans & Smith, 2002: 253). Of these feelings, only a sense of danger and worries about injuries were noticed among the children in the research group. In addition, feelings of sadness, anger, being afraid or scared and upset were communicated.

Less prevalent adversities concerning the children’s families include being separated from a parent and the loss of family members other than primary caregivers, such as a sister or extended family members. Supplementary information, provided by the key informants, revealed that although extended family members provided children with connections in the community at large, visits to these family members were often painful for the children. These family members often exploited, neglected and abused children. Neglect was also common among children who were cared for by foster parents. Both neglect and exposure to violence places children at risk of poor emotional development (Mallmann, 2003: 134)

In terms of the children’s communities or neighbourhoods, adversities such as negative gender-based relations and relocation are significant. All the children had been relocated to a community care facility (Lebone) and five of these children had also relocated to extended family members before they were accommodated at the present facility. Additional information provided by the key informants suggests that older children who lived happily with their families found adapting to Lebone more challenging. Adaptation was further compromised by the fact that it was a time-consuming process getting to know each child and how to take care of him or her. Some of the caregivers apparently maltreated the children and found it taxing having to deal with children’s grief. Further challenges associated with children’s communities or

neighbourhoods mentioned by the key informants include a lack of support from community members to families whose members had AIDS, the “culture of silence” surrounding HIV/AIDS and HIV/AIDS-related stigma and abuse. Providing assistance to those families where the HIV/AIDS status of parents was kept secret was challenging. Challenges concerning the children’s future include having to cope with the transition back into the community, before the age of twenty-one and adapting to living in the community again. One key informant believes that unless Lebone raises funds for these children to further their education, they will have to be employed at an early age. This in itself may pose difficulties, considering the rate of unemployment in South Africa.

Within the subcategory relating to the children’s school (cf. Table 6.1), learning difficulties and teasing appear to be the most common adversities among the children in the research group (also cf. Table 6.2). Although previous studies highlighted gender differences on the subject of learning difficulties experienced by children (Mather & Ofiesh, 2005: 244; Werner, 2005: 100), no definite differentiation could be made regarding the group of children selected for this study. Several studies also indicate the co-existence of anxiety, depression or emotional problems and learning disabilities in children (Morrison & Cosden, 1997: 47). Although this study does not provide evidence for the level of stress and depression experienced by the children in the research group, several indicators of anxiety, emotional problems and possible depression such as bedwetting, nightmares, withdrawal, and aggression have been recorded that may link with learning disabilities in these children. Suggesting further risk for these children is the fact that rates of school drop-out, substance abuse and subsequent delinquency were found to be significantly higher in children with learning disabilities than in those without disabilities (Cameron & Dent, 2003: 10; Morrison & Cosden, 1997: 48). Two of the key informants also mentioned that the children from Lebone are perceived differently by the other children in the school. Although not referred to as such, this may point to stigmatisation and discrimination among the learners in the school.

Exposure to the afore-mentioned adversities may render children vulnerable to a number of risks. Despite this, none of the children in the research group appear to have been involved in criminal activity, sexual exploitation or substance abuse.

1.2 External supports or support networks

This section includes a summary and discussion of the results for all eight children pertaining to this category.

1.2.1 Summary of the results

Table 6.5 summarises the results for all eight children regarding the external supports or resources that help build resilience in these children. The results are arranged according to two subcategories, namely supportive relationships and supportive environments.

TABLE 6.5: A summary of external supports

Subcategories	Number of subjects	Percentage	Subjects concerned	Gender	Responses from children and/or key informants
Supportive relationships <i>Total of (53) responses</i>	8/8	100%	1, 2, 3, 4, 5, 6, 7, 8	4 Female 4 Male	Rely on friends at Lebone for support.
	8/8	100%	1, 2, 3, 4, 5, 6, 7, 8	4 Female 4 Male	Had fulfilling relationships with at least one parent, or both parents .
	8/8	100%	1, 2, 3, 4, 5, 6, 7, 8	4 Female 4 Male	Refer to their relationship with one of the caregiver, or both caregivers from Lebone .
	5/8	62.5%	3, 4, 5, 7, 8	3 Female 2 Male	Formed supportive relationships with professionals in the community (teacher, psychologist, nurse, home-based carer, community worker).
	3/8	37.5%	2, 4, 5	2 Female 1 Male	Refer to their relationship with God .
	3/8	37.5%	2, 4, 7	2 Female 1 Male	Enjoy playing with the babies at Lebone.
	2/8	62.5%	1, 7	1 Female 1 Male	Received support from other community members (neighbours, family, friends).
	2/8	25%	4, 6	1 Female 1 Male	Have a supportive relationship with the social worker from Lebone .
	2/8	25%	2, 6	2 Male	Particularly enjoy playing with the younger children .
	2/8	25%	2, 4	1 Female 1 Male	Formed close friendships with children at school who are located within the wider community .
	2/8	25%	4, 7	1 Female 1 Male	Comment on their relationship with the pastor from Lebone.
	2/8	2.5%	1, 5	2 Female	Enjoy playing with the boys.
	1/8	12.5%	6	1 Male	Mentions the Project manager and skills development/training co-ordinator as an important person in his life.
	1/8	12.5%	7	1 Male	Has friendly relationships with other staff from Lebone such as a worker from the Skills development section and one of the people who works in the kitchen.
1/8	12.5%	4	1 Female	Receives support from an older child at Lebone (16 years).	
Supportive environments <i>Total of (16) responses</i>	8/8	100%	1, 2, 3, 4, 5, 6, 7, 8	4 Female 4 Male	Refer to Lebone
	5/8	62.5%	1, 4, 5, 7, 8	3 Female 2 Male	Refer to their school
	2/8	25%	1, 2	1 Female 1 Male	Mention the church
	1/8	12.5%	5	1 Female	Refers to a Hospice

The subsequent discussion will focus on the most prevalent external supports (concerning three or more children) within each subcategory. Regarding the first subcategory (i.e. supportive relationships), this includes responses about friends, parents, caregivers from Lebone, professionals in the community, God and the babies at Lebone. The second subcategory (i.e. supportive environments) covers responses associated with Lebone and the school.

1.2.2 Discussion of the results

As suggested in the literature review, resilience may be present to the extent that children feel that they are part of a growth-fostering relationship in which they care about others and are cared for. This perspective points to the importance for children to engage in relationships that contribute to both or all parties as this may enhance the quality of their relationships and create a powerful pathway towards resilience. Considering the processes (cf. 3.3, p. 64-7) that result from these relationships and that may account for resilience, it is important to note that these protective processes are context-specific. In other words, each context offers specific and perhaps unique qualities and potential relationships that foster or compromise resilience.

Relational qualities that foster resilience and development in children include the experience of a sense of worth, creativity, clarity, zest and connection (Jordan, 2005: 85). Bearing in mind the children in the research group, to these qualities may be added a sense of belonging, safety, courage, responsibility, motivation and purpose. For this group of children, growth-fostering relationships predominantly seemed to include those established with friends, caregivers from Lebone, professionals in the community and, to a lesser extent, relationships with the babies in the house at Lebone, and God. As indicated by previous research (O'Leary, 1998), the support derived from these relationships may lead to thriving and increased well-being.

The most significant environments or contexts offering support to these children seem to reside in the mesosystem, namely Lebone and the school. In addition to the results of the empirical investigation documented in this chapter, field observations revealed that both environments seem to be established high expectations for all of their pupils (children) and aspire to provide them with the support needed to achieve their goals. As indicated in the literature review, high expectations of teachers and the pupils themselves suffice to guarantee success for many disadvantaged children, particularly if other forms of support are available. As faith-based institutions these environments provide or host services (religious ceremonies) that are usually rendered by the church. In this way, the church does not function independently as part of the exosystem, but becomes an integral part of the mesosystem (cf. p. 21). For the children in the research group the impact of religion in their lives may be protective as religious beliefs wield further development of resilience by offering ways in which children can give meaning to their pain and suffering (Grotberg, 2003: 152). Spiritual teachings also advocate resilience strengths such as compassion and forgiveness, deepens and expands children's values and perspectives, and allows children to view adversity as an opportunity for personal growth and development. An organized spiritual community lays the foundation for self-acceptance and tolerance of others as it provides a context for hope, reassurance and comprehension of that which is beyond the child's (current) understanding. A high level of caring and support was evident within the school.

1.3 Inner strengths

Orphaned children need access to inner resources or strengths in order to access their external resources. Inner strengths that characterise the children in the research group are summarised and discussed in this section.

1.3.1 Summary of results

Table 6.6 provides a summary of the results for all eight children. The responses of the children and those of the key informants are grouped according to twenty-one associated subcategories (inner strengths), sixteen of which were based on the individual spiritual, cognitive, social as well as behavioural, physical, and emotional or affective competencies or resilience traits discussed in Chapter 2 (cf. 4.1.1, p. 26-30), and the internal assets listed by the Search Institute's Framework of developmental assets (cf. Table 3.1). Five

additional inner strengths were identified, independent from those indicated in Chapters 2 and 3, namely accountability, dedication, assertiveness, authority and obedience. Although these inner strengths are for the most part listed separately, many of these strengths are interrelated, as suggested in the literature review and the results of the empirical study. For instance, achievement motivation and self-efficacy may lead to a positive view of oneself and one's future. Collectively, these three inner strengths may also lead to problem-solving and goal-setting.

TABLE 6.6: A summary of inner strengths

Subcategories	Number of subjects	Percentage	Subjects concerned	Gender	Responses from children and/or key informants
Morality, social values and resistance skills <i>Total of (43) responses</i>	6/8	75%	1, 2, 4, 5, 6, 8	3 Female 3 Male	Are against violent behaviour such as fighting with or beating others.
	5/8	62.5%	3, 4, 5, 6, 7, 8	2 Female 3 Male	Display resistance skills, morality and social values in that they avoid early involvement in serious relationships with the opposite sex.
	3/8	37.5%	5, 7, 8	1 Female 2 Male	Caring for others seems to carry particular importance.
	3/8	37.5%	2, 4, 8	2 Female 1 Male	Express clear judgement.
	3/8	37.5%	4, 7, 8	1 Female 2 Male	Are perceived as responsible.
	3/8	37.5%	2, 3, 5	2 Female 1 Male	Are well-mannered.
	3/8	37.5%	3, 5, 8	2 Female 1 Male	Value love.
	1/8	12.5%	8	1 Male	Apologises when he did something wrong.
	1/8	12.5%	7	1 Male	Is against crime.
	1/8	12.5%	8	1 Male	Believes in justice.
	1/8	12.5%	7	1 Male	Shows respect.
	1/8	12.5%	5	1 Female	Believes in fair play.
	1/8	12.5%	8	1 Male	Is perceived as being accountable.
	1/8	12.5%	4	1 Female	Is against neglect and self-destructive behaviour.
	1/8	12.5%	8	1 Male	Tends to make friends with children who are willing to work , indicating social values.
	1/8	12.5%	2	1 Male	Believes in fairness.
	1/8	12.5%	8	1 Male	Values honesty.
	1/8	12.5%	3	1 Female	Values independence.
	1/8	12.5%	3	1 Female	Values loyalty.
	1/8	12.5%	3	1 Female	Avoids "doing silly stuff."
1/8	12.5%	7	1 Male	Shows appreciation to others.	
1/8	12.5%	8	1 Male	Is perceived as being well-behaved.	
1/8	12.5%	7	1 Male	Asks for forgiveness when he did something wrong.	
1/8	12.5%	5	1 Female	Resists negative peer pressure and dangerous situations.	
Optimism and positive identity <i>Total of (15) responses</i>	8/8	100%	1, 2, 3, 4, 5, 6, 7, 8	4 Female 4 Male	Exhibit a positive view of their future and a happy disposition.
	2/8	25%	3, 5	2 Female	Positive childhood memories , associated with photographs of when the children were younger, point to positive identity.
	2/8	25%	4, 5	2 Female	Display positive identity given their belief that most people love them.
	1/8	12.5%	3	1 Female	Displays positive identity given her belief that most people like her.
	1/8	12.5%	7	1 Male	Displays optimism and positive identity, given the pride he derives from playing soccer well.
1/8	12.5%	3	1 Female	Communicates belief and confidence in own fair play , suggesting positive identity.	
Religion and faith <i>Total of (9) responses</i>	4/8	50%	1, 2, 4, 5	3 Female 1 Male	Find healing in their faith and religion.
	3/8	37.5%	2, 4, 5	2 Female 1 Male	Find comfort in their faith and religion.
	1/8	12.5%	4	1 Female	Faith and religion provide safety.
	1/8	12.5%	5	1 Female	Finds purpose in her faith and religion.
Achievement motivation <i>Total of (8) responses</i>	8/8	100%	1, 2, 3, 4, 5, 6, 7, 8	4 Female 4 Male	Show achievement motivation considering that they are motivated to do well in school.

Subcategories	Number of subjects	Percentage	Subjects concerned	Gender	Responses from children and/or key informants
Emotional management <i>Total of (7) responses</i>	7/8	87.5%	1, 2, 3, 4, 5, 6, 8	4 Female 3 Male	Show the ability to recognise feelings and control undesirable feelings through emotional management.
Trust <i>Total of (7) responses</i>	7/8	87.5%	1, 2, 3, 4, 5, 6, 8	4 Female 3 Male	Report that they can trust others.
Humour <i>Total of (3) responses</i>	3/8	37.5%	3, 5, 7	2 Female 1 Male	Use humour in facing difficulties.
Obedience <i>Total of (2) responses</i>	1/8	12.5%	1	1 Female	Creates an imaginary family .
	2/8	25%	1, 4	2 Female	Exhibit obedience .
Intelligence <i>Total of (2) responses</i>	2/8	25%	1, 4	2 Female	Good academic interest, performance and achievement .
Responsibility <i>Total of (2) responses</i>	1/8	12.5%	7	1 Male	Takes on the care of the younger children at home.
Assertiveness <i>Total of (2) responses</i>	1/8	12.5%	8	1 Male	Is perceived as responsible.
	2/8	12.5%	7, 8	1 Male	Takes charge of other children .
Ability to lead <i>Total of (2) responses</i>	2/8	25%	7, 8	2 Male	Show leadership .
Authority <i>Total of (2) responses</i>	2/8	25%	7, 8	2 Male	Show the ability to organise children and the children listen to them .
Integrity <i>Total of (1) response</i>	1/8	12.5%	1	1 Female	Acts on convictions and stands up for her beliefs .
Initiative <i>Total of (1) response</i>	1/8	12.5%	1	1 Female	Uses initiative in dealing with adversity .
Generosity <i>Total of (1) response</i>	1/8	12.5%	4	1 Female	Shares gifts (sweets) with other children.
Interest <i>Total of (1) response</i>	1/8	12.5%	3	1 Female	Shows genuine interest in others .
Accountable <i>Total of (1) response</i>	1/8	12.5%	8	1 Male	He can be relied on .
Disciplined <i>Total of (1) response</i>	1/8	12.5%	5	1 Female	Apparently displays adherence to self-imposed rules .
Dedicated <i>Total of (1) response</i>	1/8	12.5%	5	1 Female	Is committed to do her work .

Subcategories comprising responses concerning three or more children include morality, social values and resistance skills; optimism and positive identity; religion and faith; achievement motivation; emotional management; trust; and humour. These subcategories are thus considered the seven most important inner strengths associated with the children in the research group. The following discussion focuses on the three most important subcategories in Table 6.6 (i.e. morality, social values and resistance skills; optimism and positive identity; religion and faith). The importance of a subcategory is determined by the number of responses associated with that subcategory. The subsequent discussion will focus on responses that concern three or more children within each of the three subcategories. The first subcategory, morality, social values and resistance skills, involves: being against violence, avoiding early involvement in serious relationships with the opposite sex, caring for others, expressing clear judgement, being responsible, well-mannered and valuing love. The second subcategory, optimism and positive identity, includes, having a positive view of one's future and a happy disposition. The third subcategory, faith and religion, covers responses about comfort and healing.

1.3.2 Discussion of the results

The results of the literature review suggest that, similar to certain risk factors, protective factors or inner strengths tend to co-occur in a specific population, for instance, children of poverty, or within a certain period of development, for example, adolescence. According to Werner (2005: 98), "the presence of a certain cluster of (interrelated) variables that buffer adversity at one point in time also makes it more likely that other protective mechanisms come into play at later stages of development." Thus, the presence of the following variables indicated by the results of this study may link to subsequent stages of development and predict the quality of adaptation in young adulthood and midlife.

The most important factors thought to buffer against the possible negative impact of environmental risk factors on the children's lives appear to be morality, social values and resistance skills; optimism and positive identity; and religion and faith. These factors have four features in common: they reflect children's belief systems, serve to motivate children, include cognitive abilities primarily, and create direction for children's efforts. Morality, social values and resistance skills denote beliefs concerning what is right and wrong. A belief in one's own competence and skills, that things can change for the better, that there is hope for the future, and that one can control the direction of one's life, represents optimism, positive identity and faith. Religion may be understood as the external expression of a child's faith or inner system of beliefs, which includes ethical codes and various forms of worship (Greene & Conrad, 2002: 47). In the truly resilient child, these beliefs are tempered by a healthy sense of reality (Fetcher & Forel, 1935: 301).

Most of the responses associated with the subcategory related to morality, social values and resistance skills concern the boys in the research group, whereas the two subsequent subcategories, optimism and positive identity, as well as religion and faith, undoubtedly contain more responses from the girls. The most important responses pertaining to the subcategory associated with morality, social values and resistance skills include

stances against violent behaviour, avoiding early involvement in serious relationships with the opposite sex, and caring for others. All the children in the research group exhibited optimism and positive identity in that they displayed a positive view of their future and a happy disposition. Optimism may be a particularly valuable personality factor for those in the group who commented on violence. Previous research indicates that this quality promotes positive adjustment in children who are exposed to violence in their homes and communities, and may lead to improved self-esteem functioning in adolescence (Williams, 2002: 205). Significant responses associated with spiritual characteristics include finding healing and comfort in faith and religion.

1.4 Interpersonal, problem-solving skills

This section provides a summary and discussion of the results for all eight children pertaining to this category.

1.4.1 Summary of the results

Table 6.7 provides a summary of the results for all eight children in the research group linked with interpersonal, problem-solving skills. The responses associated with this category are presented according to eight corresponding subcategories, namely (1) constructive use of time, (2) goal-setting, purpose in life and commitment to learning, (3) problem-solving ability, self-efficacy and personal power, (4) open communication, (5) perseverance, (6) obedience, (7) hope, and (8) acceptance. Excluding the sixth and eighth subcategories, these subcategories (interpersonal, problem-solving skills) correspond with resilience factors cited by Riley (2002: 181), Grotberg (2003: 4), Benard (1991: 11-12; 2004: 2 of 8), Millgram & Palti (1993: 207), Vanderpol (2002: 303-4), and the Search Institute's Framework of developmental assets (cf. Table 3.1).

The two remaining subcategories, obedience and acceptance, are newly identified interpersonal, problem-solving skills emerging from the results of this study.

TABLE 6.7: A summary of Interpersonal, problem-solving skills

Subcategories	Number of subjects	Percentage	Subjects concerned	Gender	Responses from children and/or key informants
Constructive use of time <i>Total of (24) responses</i>	8/8	100%	1, 2, 3, 4, 5, 6, 7, 8	4 Female 4 Male	Play as a means of using time constructively.
	5/8	62.5%	3, 5, 6, 7, 8	2 Female 3 Male	Enjoy creative activities (such as drawing, writing, dancing, drama).
	5/8	62.5%	2, 5, 6, 7, 8	2 Female 3 Male	Enjoy sports , for instance, football, netball or athletics.
	3/8	37.5%	2, 7, 8	3 Male	Watch television.
	3/8	37.5%	2, 3, 5	2 Female 1 Male	Enjoy working.
Goal-setting, purpose in life and commitment to learning <i>Total of (8) responses</i>	8/8	100%	1, 2, 3, 4, 5, 6, 7, 8	4 Female 4 Male	Indicate goal-setting, purpose in life and commitment to learning , related to caring for and helping others.
Problem-solving ability, self-efficacy and personal power <i>Total of (8) responses</i>	8/8	100%	1, 2, 3, 4, 5, 6, 7, 8	4 Female 4 Male	Display problem-solving ability, self-efficacy and personal power given their belief in their ability to exercise control over their future and over threatening situations.
Open communication <i>Total of (8) responses</i>	8/8	100%	1, 2, 3, 4, 5, 6, 7, 8	4 Female 4 Male	Employ open communication as a means of dealing with problems and receiving support or help.
Perseverance <i>Total of (4) responses</i>	4/8	50%	1, 2, 3, 7	2 Female 2 Male	Show perseverance when faced with difficulties or failure.
Obedience <i>Total of (2) responses</i>	2/8	25%	6, 7	2 Male	Exhibit obedience when disciplined.
Hope <i>Total of (1) responses</i>	1/8	12.5%	5	1 Female	Uses hope in dealing with adversity.
Acceptance <i>Total of (1) responses</i>	1/8	12.5%	1	1 Female	Accepts adversities with regard to her family and home environment

The following pie diagram illustrates the respective subcategories listed in Table 6.7 in terms of their relative significance.

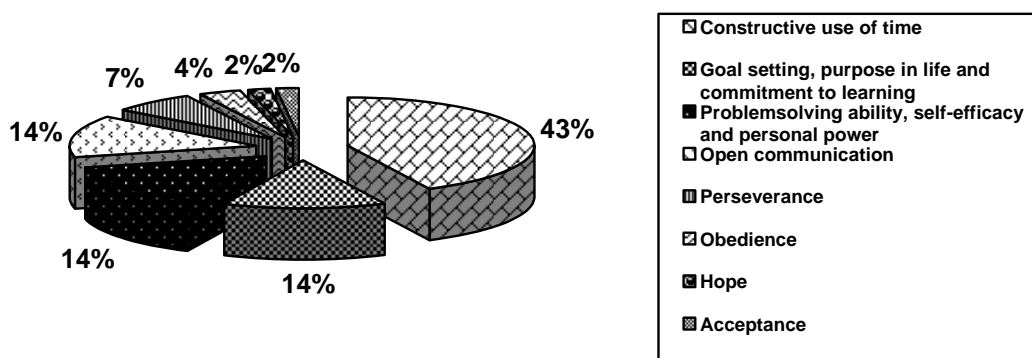

Diagram 6.3: Significance of interpersonal, problem-solving skills according to eight subcategories, as communicated by the children and/or key informants.

The most important subcategory associated with interpersonal, problem-solving skills among the children in the research group appears to be constructive use of time, as the responses related to this subcategory constitute 43% of the responses for all eight subcategories. Subcategories of moderate importance seem to be goal-setting, purpose in life and commitment to learning; problem-solving ability, self-efficacy and personal power; and open communication. The responses associated with each of these subcategories constitute 14% of the responses for all eight subcategories. Subcategories of lesser importance appear to be perseverance, obedience, comprising 7% and 4% of the responses for all eight subcategories respectively, followed by hope and acceptance, each representing only 2% of all the responses in Table 6.7.

As with the previous sections, the responses (interpersonal, problem-solving skills) that correspond with the three most significant subcategories, as well as the responses that concern three or more children within each subcategory, are discussed in the next section. The first subcategory includes playing, creative activities, sports, viewing television and working, as a means of using time constructively. The second subcategory, goal setting, purpose in life and commitment to learning focuses on caring for and helping others, whereas the third subcategory (i.e. problem solving ability, self-efficacy and personal power) focuses on the children's belief in their ability to exercise control over their future and over threatening situations.

1.4.2 Discussion of the results

For the children in the research group, constructive use of time predominantly involves playing, taking part in other creative activities such as writing, drawing, dancing or singing, and doing sports. These activities seem to reflect their interests and are mostly regarded as enjoyable by the children. Although listed separately, these activities primarily involve play. Play fosters resilience in that it allows children to expand their

understanding of themselves and others, their knowledge of the physical world, and their ability to communicate with peers and adults in order to master the more formal skills of life, namely (1) to relate with peers according to rules, (2) to progress from free play to play that may be elaborately structured by rules and may demand formal teamwork, such as soccer, and (3) to master social studies, reading and arithmetic (Gingsburg, The Committee on Communications & The Committee on Psychosocial Aspects of Child and Family Health, 2007: 182-4; McConnel, 1974: 597). As such, for the children in the research group, play seems to comprise four factors in particular: life preparation, sense of communion, mastery and workmanship. In play children are more or less independent and may be able to express themselves more freely. This suggests that play may hold therapeutic value for these children. Three children also enjoy working, and three of the boys in the group watch television as a constructive use of time.

The responses associated with goal-setting, purpose in life, and commitment to learning concern all eight children in the research group and mainly involve caring for and helping others. These interpersonal, problem-solving skills have frequently been correlated with optimism (Williams, 2002: 205). Evidently, this correlation also applies to the children in the research group (cf. Table 6.7), and relates to their view of the future. Caring and helping, specifically among this group of children and also towards other children from Lebone, seem to strengthen the cohesiveness of the whole group (i.e. all the children at Lebone) and contribute to a sense of family or a kind of tribal belonging, respect and responsibility. These qualities are thought to play a crucial role in sustaining and fostering resilience, in particular among this group of children. Qualities such as caring and helping also seem to extend beyond this group of children, including the caregivers and other staff members of Lebone. By helping others, children may also develop self-efficacy and self-esteem.

All the children in the research group exhibit problem-solving ability, self-efficacy and personal power, given their belief in their ability to exercise control over their future and over threatening situations. For the sake of clarification, it is important to note that these qualities are related to specific incidents. Thus, although children may display self-efficacy or problem-solving in certain situations or areas of their lives, they may not necessarily exhibit these qualities in other areas or contexts pertaining to their lives. Nevertheless, these qualities are important indicators of resilience that may develop and broaden in scope as children mature.

1.5 Complementary responses from key informants regarding external supports, inner strengths, and interpersonal, problem-solving skills

The three categories mentioned previously, namely external supports, inner strengths, and interpersonal, problem-solving skills refer to protective factors that help children to resist or ameliorate risk and increase resilience. In addition to the information provided in the sections pertaining to these three categories, this section summarises and provides complementary information (results) concerning the protective factors thought to decrease risk in the lives of the children in the research group. This is followed by a discussion of the results.

1.5.1 Summary of the results

Table 6.8 provides a summary of the results associated with protective factors for all eight children, as communicated by the key informants. The results are linked to five subcategories, namely the (1) the child, (2) the school, (3) Lebone, (4) the community or neighbourhood, and (5) the family.

TABLE 6.8: A summary of protective factors				
Subcategories	Number of respondents	Percentage	Respondent	Responses from key informants
Children <i>Total of (9) responses</i>	3/7	43%	Teacher A Teacher B Teacher C	Tertiary education will increase children's ability to cope with living in the community again.
	2/7	28.6%	Caregiver B Pastor	Children show no problems in adapting to a new environment.
	1/7	14.3%	Caregiver B	Most of the children want to follow a profession and seem positive about their future.
	1/7	14.3%	Social worker	Younger children find it easier to adapt to their new environment (Lebone).
	1/7	14.3%	Pastor	The children had feel welcome at Lebone.
	1/7	14.3%	Pastor	Children are accepting new religious teachings.
School <i>Total of (7) responses</i>	1/7	14.3%	Pastor	Teachers play an important role in creating a culture where children are not teased.
	1/7	14.3%	Teacher A	The teachers teach the children not to discriminate against one another.
	1/7	14.3%	Teacher A	All the children are treated equally at the school.
	1/7	14.3%	Teacher A	No sexual activity was observed amongst learners.
	1/7	14.3%	Teacher A	The school receives a lot of support from the Department of Education and the church.
	1/7	14.3%	Teacher A	Ceremonies held by the church at the school help to instill morals and good values in the children.
Lebone <i>Total of (6) responses</i>	1/7	14.3%	Pastor	The training and support received at Lebone is thought to help children cope and deal with being teased by other children at school.
	1/7	14.3%	Social worker	The children are allowed to stay at Lebone until the age of eighteen. Thereafter, they are given the opportunity to both remain and work at Lebone and attain skills, or to leave and possibly live with extended family members.
	1/7	14.3%	Social worker	Lebone would facilitate and assist the transition back into the community.
	1/7	14.3%	Caregiver A	Authoritative parenting style and resilience enhancing practices adopted by caregiver.
	1/7	14.3%	Teacher A	The children are taught values and "attitudes" at Lebone.
	1/7	14.3%	Pastor	Children are well taken care of at Lebone.
Community/ Neighbourhood <i>Total of (2) responses</i>	1/7	14.3%	Pastor	Contributions made by members from the wider community.
	1/7	14.3%	Social worker	Some of the people in the community provide support to those infected and affected by HIV/AIDS.
Family <i>Total of (1) responses</i>	1/7	14.3%	Social worker	Children could possibly live with extended family members after the age of eighteen.

The relative importance of each subcategory is illustrated in Diagram 6.4.

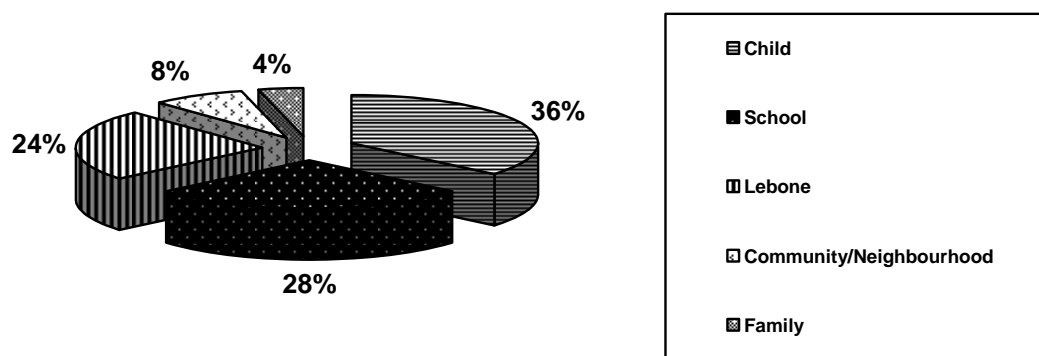

Diagram 6.4: The importance of the protective factors according to five subcategories, as communicated by the key informants.

The most significant subcategory associated with inherent protective factors concerns the children in the research group as the responses linked to this subcategory constitute 36% of the responses for all five subcategories, as given by the key informants. The next important subcategory concerns the school, representing 28% of the responses for all five subcategories. The following subcategory, Lebone, represents 24% of all the responses. The subcategories related to the children's community or neighbourhood and their families seem to be less important. Each subcategory represents 8% and 4% of all the responses, respectively. The following discussion focuses on the three most important subcategories (i.e. the subcategories concerning the children, the school and Lebone).

1.5.2 Discussion of the results

The results depicted in Table 6.8 noticeably confirm and support the results presented in Tables 6.5, 6.6, 6.7. Inherent protective factors pertaining to the children themselves generally thought to facilitate adaptation include being accepting of (new) religious teachings, (being accommodated at Lebone at) a younger age, the absence of significant problems, and feeling welcome at Lebone. Most of the children want to follow a profession and seem positive about their future. Accordingly, three key informants argued that if the children are to educate themselves further, they will find it easier coping with living in the community again. According to the views of the key informants, Lebone could play a key role in terms of the children's future education and successful adaptation at young adulthood.

Protective factors related to the children's school include the absence of sexual activity, stigmatisation and discrimination among learners in the school. On the subject of stigmatisation and discrimination, some of the key informants reported the opposite (cf. Table 6.2). Community involvement at Lebone, as well as Lebone itself, provide training and support to the children. This contributes to a sense of pride, enabling the children

to deal with adversities such as being teased at school. Ceremonies held by the church, at the school, apparently assist in instilling morals and good values in the children. As suggested, these qualities in the children also seem to be cultivated by staff members from Lebone. One of the caregivers in particular also seems to employ care-giving practices that foster resilience.

2. CONCLUSIONS

The following insights and conclusions are based on the results of the study. The conclusions regarding the empirical investigation are also based on my observations made during this enquiry.

2.1 Conclusions regarding the literature review

In respect of the research questions and aims, an extensive literature review was undertaken. The aim of this review was to provide a conceptual basis with the intent of informing and guiding the empirical investigation. The literature review (Chapters 2 and 3) generated the following insights and conclusions:

- Psychological resilience is nascent in all children.
- Resilience is a process comprising various related processes and constructs.
- Resilience entails unpredicted or markedly successful adaptations to negative life events, trauma, stress, and other forms of risk. Resilience also involves competence in daily functioning.
- Resilience is a biopsychosocial and spiritual phenomenon.
- The prevalence of risk factors and associated vulnerability does not necessarily lead to poor developmental outcomes in children.
- The study of resilience has shifted the focus from risk factors to the process of how children successfully negotiate risk. Hence, resilience is concerned with individual variations in response to risk.
- Resilience is influenced by diversity including variables such as ethnicity, race, gender, culture, age, religious affiliation, economic status, developmental stage as well as physical and mental ability.
- The current situation or external realities in South Africa necessitates (the development of) psychological resilience in children affected by HIV/AIDS.
- Limited or constrained resilience in children may lead to negative developmental outcomes that may have a negative impact not only on the individual, but also on the external environment. In turn, the specific social context or “quality of the external environment” may affect the prevalence of positive developmental outcomes in the youth. Hence, resilience is a complex and dynamic phenomenon, influenced by various internal and external factors. Therefore, consideration of bidirectional influence and the application of transactional-ecological models plays a fundamental role in the conceptualisation of the development of resilience.

- Self-efficacy may be considered a key characteristic or attribute of resilience that operates in conjunction with other internal assets, and that is related to various external assets. The appraised characteristic of the stressful context, including its controllability, is thought to influence coping.
- The phases or different levels of development, and by implication the various tasks, competencies and realities of each stage, may be applied to contribute to a clearer understanding of resilience.
- The aspects or factors that lead to poor developmental outcomes in children may be used to identify and describe issues of outcome specificity or causality and pathways to disorder.
- Practice based on principles of resilience assumes a strength-based perspective.

2.2 Conclusions regarding the research methodology

The use of a qualitative, explorative approach proved to be fitting for this research as it informed and answered the specific research questions and aims. This approach also allowed the researcher to gradually establish a trusting relationship with the respondents which was considered vital in gathering sensitive information. As anticipated and outlined in Chapter 4, the preservation of the children's human dignity and welfare, also through their own advocacy, was highlighted. The use of a standardised scale or questionnaire would probably not have yielded all the relevant information regarding exposure to adverse experiences plus the related responses, coping mechanisms and resilience of the respondents, as they would have responded to the given questions only, thus excluding the broad spectrum of their experiences. Although this method was more exhausting and time-consuming than the use of a quantitative method of data collection, the wealth of information and relevance to understanding the emotional and social lives of the children make the effort worthwhile.

The use of participatory research methods seemed conducive to the purposes of the study in that they provided an opportunity for learning, direct community involvement, reflection and change, and improvement of research strategies and skills. Interaction between role-players at various levels could also be observed which indirectly contributed to a clearer understanding of the relationship between these role-players, the different contexts in which they find themselves and the children selected for this study.

In addition, the case study approach recognised and validated the unique nature of individuals and the social contexts that permeate their lives, allowing for comparative analysis. The distinctive and common patterns of adaptation among individuals within a particular group could thus be explored.

2.3 Conclusions regarding the empirical investigation

Resilience is a dynamic phenomenon, and depends on the life context. Therefore, children's responses to constant interaction with the environment may vary according to situational and personal factors that include both risk and protective factors. This results in varying degrees of well-being and associated resilience. The

results of the empirical investigation revealed that, although adversities (threats) are grouped and located within different areas (i.e. within the individual, the family, and those experienced outside the family or within community organisational domains (Dent & Cameron, 2003: 4, Winslow *et al.*, 2005: 338 and Grotberg, 2003: 2), adversities and stressors (cf. Tables 6.1 and 6.2) and/or risk factors interrelate, interact and their effects permeate different systems, aspects and time frames of the individuals' lives. For instance, poverty may cause poor care and neglect of children, affect their access to health care, lead to learning disabilities in children, cause dysfunction within the family environment and give way to violence within children's communities and families. These place children at risk for poor developmental outcomes that may compromise their future success. Similarly, situational protective factors interrelate, interact and permeate different aspects and time frames of children's lives and may, therefore, exert their influence throughout development. The situational factors listed in Tables 6.1, 6.2 and 6.5 are also thought to include intensity, quality, duration, number and frequency of stressors and protective factors.

Current situational risk factors, although not explicitly communicated as such during the formal interviews, but perceived and noted during the empirical investigation, were that caregivers are overwhelmed and children's needs do not receive enough attention. This may be due to the fact that caregivers are isolated from their families, and often find it difficult to control their anger and stress, and seem to have financial and personal problems that may place children at higher risk of abuse and neglect. Psychological maltreatment of children by some carers was, however, mentioned clearly. Some caregivers appeared to successfully socialise children by transmitting values and teaching adaptive strategies, enabling children to succeed. This was evident in the training and (community) support received at Lebone that helped children cope and deal with being teased at school. Messages given to children, whether direct or indirect (for example, "We love you and we are there for you") may protect them against discrimination, inequality and daily hassles. Thus, I conclude that the children's capacity to transcend the risk of oppressive environments can, generally speaking, be attributed to this group's (i.e. the children and staff at Lebone's) culturally unique protective factors, for instance, positive social orientation, including peer friendships, regard for others and servitude. Children who were assigned regular chores, or asked to look after younger siblings, took care of younger children out of their own free will, or who had taken care of ill parents, seemed to develop inner strengths, especially when these are associated with strong "family" ties. Common experiences among the children in the research group, such as the illness and death of their parents, are perhaps protective to the extent that they apparently promote group cohesiveness which incorporates factors such as empathy, understanding and other forms of support, and seem to bring about a sense of connectedness and perhaps family. Giving children responsibility also appeared to signal their worthiness and capability of contributing positively to their environment. Other significant situational, protective factors appeared to be the fact that both the school and Lebone are faith-based institutions that advocate spiritual teaching. Moreover, spirituality may be considered a key factor in fostering resilience in these children as it encompasses existing and shared inner strengths as well as interpersonal and problem-solving skills, such as hope and morality. These culminate in the children's belief systems, and may also inform and provide guidance regarding other aspects of their lives. As children build on and develop these inner developmental, asset-related traits they may construct a strong internal locus of control that seems fundamental to transcending risk in their lives. Hence, these children's beliefs and convictions can be powerful healing tools.

Although most of the children in the research group seemed to exhibit symptoms of trauma and emotional disturbance, such as nightmares, withdrawal, difficulty concentrating, unpleasant memories, loss of self-esteem, or times of great sadness (Parkinson, 2000: 52-73), they are getting on with their lives, going to school, making friends, and apparently building constructive lives as they adapt to life at Lebone. Therefore, I conclude that the children's responses to environmental adversity, or the subsequent effects thereof, portray a more accurate picture of the children's resilience than the attainment of developmental outcomes or absence of problems or risk factors such as depression or learning difficulties alone. This viewpoint correlates with the definition of resilience formulated for this study (cf. p. 41), in that resilience does not prohibit recoil and regression. Given this perspective and the clear indications of rebound or progress among the children in the research group, specifically reported by key informants, their lives appear to be a testimony to the astonishing human capacity for resilience. Personal factors, underlying those listed in Tables 6.6 and 6.7, thought to contribute to their ability to adapt to their circumstances include curiosity, compassion, gratefulness, the capability of invoking good internalised self-images and being in touch with the effects, the ability to draw support from others and to set clear goals, resourcefulness and a fighting spirit. In general, the children in the research group appear to be surprisingly independent at young ages; are friendly, socially responsive (although for some this mostly applied to the children and staff at Lebone), sensitive, and co-operative, with a self. During the empirical investigation, I observed and concluded that these virtues could be cultivated, that traumatic memory may be a filter which determines how children later respond to events, and that teachers and caregivers perform a vital role in facilitating the process of becoming resilient and successful later in life.

2.4 Conclusions regarding the limitations of the empirical investigation

A number of limitations became evident during the course of this study. These are recorded here as guidelines to future researchers in the field.

- As the number of children who participated in the study is limited, the findings and results cannot be generalised to a larger population of pre-adolescents, but should only be viewed as specific tendencies.
- The significance of the identified subcategories in Tables 6.1-8 only applies to the information as communicated and recorded during the empirical investigation. Further investigation might reveal additional subcategories, perhaps of similar significance, or alter the significance of existing categories.
- The identified resilience strengths cannot be viewed as definite but purely as indicators of resilience. Yet this study was unable to provide explicit answers concerning positive long-term outcomes for the children in the research group.
- The language proficiency of the children necessitated the use of a translator/interpreter which limited the extent of direct contact between the researcher and the children. As a result, emotion and spontaneity were apparently lost between the researcher, the child and the translator. The translator's presence may also have influenced the children's responses.

3. SUMMARY

This chapter classified, analysed, compared and systematised the results of the empirical investigation. Emerging key themes focused on the experience of illness, death, poverty and violence and the important role morality, social values, resistance skills, and religion and faith play in assisting these children with their purpose in life. Towards this end, constructive use of time, commitment to learning, goal-setting, problem-solving ability and self-efficacy seem to play a fundamental role in attaining their future projections. Thus, qualities such as optimism, perseverance and hope seem to permeate the children's process of recovery. Research also shows that for this group of children strong relational networks of support, particularly friendships with other children from Lebone apparently contribute towards the development and sustainment of resilience. As a final conclusion to the results and conclusions presented in this chapter, the following chapter imparts a living theory of resilience.

Chapter 7

TOWARDS A LIVING THEORY OF PSYCHOLOGICAL RESILIENCE

1. INTRODUCTION

This chapter presents a living theory of psychological resilience in pre-adolescents affected by HIV/AIDS, based on the conclusions drawn from the literature review and empirical investigation presented in the previous chapter. This theory is presented according to five interrelated constructs, namely (1) causal conditions, (2) the studied phenomenon - psychological resilience, (3) the context, (4) action/interaction strategies, and (5) consequences. Strategies, which might have some promise for practical application, are suggested and recommendations for future research are made.

2. A LIVING THEORY OF PSYCHOLOGICAL RESILIENCE

The formulation of a living theory of psychological resilience in pre-adolescent children affected by HIV/ADS is based on the integration of and relationship among four identified categories of factors related to results of the empirical investigation, namely (1) external realities, (2) external supports, (3) inner strengths, and (4) interpersonal problem-solving skills. These factors are linked to the following interrelated constructs: (1) the causal conditions, (2) the phenomenon, (3) the context, (4) action/interaction strategies, and (5) consequences. These are used to construct an integrative framework (cf. Figure 7.1) which will guide the formulation of this theory.

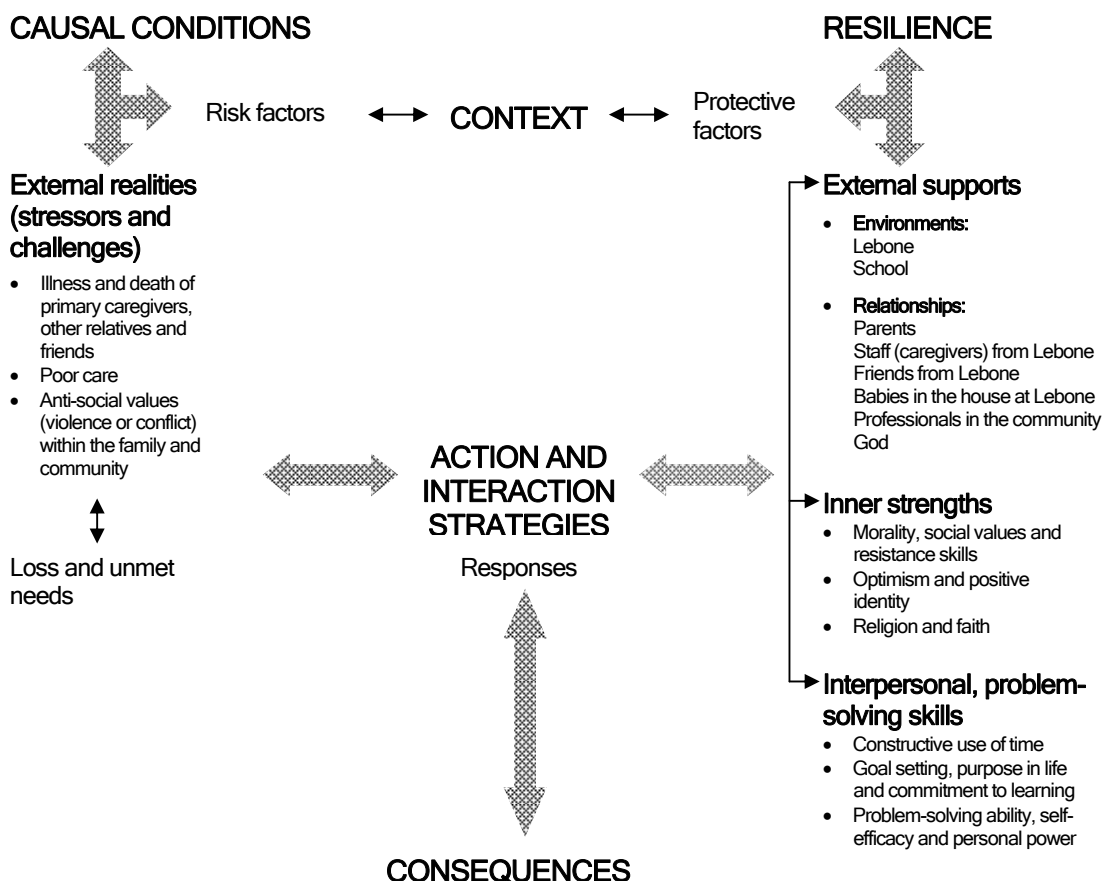

Figure 7.1: An integrative framework of a living theory of psychological resilience among HIV/AIDS-affected pre-adolescents

As the results of the empirical investigation rest on a limited number of cases, the emergent theory is tied to existing literature in order to enhance the internal validity, generalisability, and theoretical level of the theory based on the case study research. Hence, my formulation and articulation of a living theory of psychological resilience of children orphaned by AIDS rests largely on Maslow's theory of human motivation, Bandura's social learning theory, and Bronfenbrenner's ecological perspective and developmental theory posited by theorists such as Piaget and Erickson. In addition, most of my understanding has been drawn from psychoanalytic sources, such as the work of Arthur Janov, Alice Miller and Eric Berne. Although two of the excerpts used in the text refer to the younger children at Lebone, I believe that this additional information relates to the children in the research group and contributes to the conceptualisation and understanding of this theory. Therefore, the use of these excerpts is considered valid. For the purposes of the next discussion, the categories illustrated in Figure 7.1 are re-organised and presented as: (1) causal conditions, (2) psychological resilience, (3) contextual specificity of resiliency processes and action or interaction strategies, and (4) consequences.

2.1 Causal conditions

Two distinct judgements, required to identify psychological resilience, were considered and taken as point of departure to investigate, ascertain and explain the causal conditions related to psychological resilience. These are, first, “that there has been a significant threat to the [development or adaptation of the] individual, typically indexed by high-risk status (e.g., born in poverty to a single parent who has not finished high school) or exposure to severe adversity or trauma (e.g., family violence, war or death of a parent)”, and secondly, “that the quality of adaptation or development is good” (Masten & Coatsworth, 1998: 206).

In my opinion, significant threats or adversities faced by the children in the research group inevitably hold that they experience loss of some kind, and that their needs, as a consequence, are not met or fulfilled. For example, children who face the serious illness of their primary caregivers may experience neglect and abuse, along with the loss of education and health, as well as the need for education, attention and care. The destruction caused by HIV/AIDS may be experienced as both external loss (i.e. social loss due to the death of parents and friends) and internal loss, such as spiritual or emotional loss (i.e. the loss of security, purpose and aim, esteem or self-image) (Parkinson, 2000: 47-51). According to Janov (1973: 24), when children’s needs are not met or fulfilled, they experience tension. By this, the author means unnatural tension. Hence, needs are defined as “those things without which, or without a sufficient amount of which, a negative or undesirable state [disequilibrium] occurs” (Louw, 2000: 65). Thus, I conclude, when a child’s needs are not met, the system is unbalanced, implying that it is unnatural and susceptible to, or in a state of, inner tension. Natural tension, on the other hand, has a place in the ordinary psychology of the child (Janov, 1973: 51).

In keeping with this stance, I argue that hurt or painful feelings, resulting from loss and consequent unmet needs, function as the stressor and initiating event in the resilience process (cf. 4.6.3, p. 35; Figure 2.8). Thus, corresponding with the findings of the literature review (cf. 4.1, p. 16-7; 4.7, p. 37), the causal conditions for the identification and manifestation of psychological resilience processes go much deeper than just the adversity or threat itself, but relates more specifically to the experience of loss and unmet needs by children. The information gathered during the empirical investigation indicates that the apparent unmet needs of the children in the research group (such as the need for care, approval, acceptance, individual attention, education, expression of emotions, the need to be part of the wider community and to be valued as a member of society), or deprivation may originate primarily from two kinds of scenarios or sources: from child-parent (or adult) relations, and from the incidence of momentous threats or adversity in children’s lives, such as abuse by means of corporal punishment or the serious illness, death and loss of primary caregivers due to HIV/AIDS. In respect of child-parent relations, Janov (1973: 29) explains that children are born with biological needs. When, for various reasons, these needs are not met by their primary caregivers or, as in the case of the children in the research group, other adult caregivers, “minor primal scenes” occur. Typically, these “minor primal scenes” represent the countless minor experiences, involving family as well as community members, in which children were, or are ridiculed, rejected, neglected, humiliated, or driven to perform (Janov, 1973: 27, 29). The occurrence of each of these experiences means that the child will hurt. Janov (1973: 25) refers to this hurt as “primal pain.” Similarly, when momentous threats or adversity take place in their lives, children experience pain. As indicated in the non-empirical investigation, it is not the scene as

such (i.e. minor or momentous), but the meaning which the child attributes to the event that determines the extent of devastation and consequent (stress and) pain the child may experience (Janov, 1973: 35; Wessells & Monteiro, 2000: 182).

In response to pain, children follow distinct adaptive paths that may entail the use of defences, or specifically, “a set of behaviours which automatically function to block primal feelings” (Janov, 1973: 60). This implies that the pain is never fully experienced, that is to say, the experience is aborted and the pain is covered before its total impact can be felt. In so doing, children engage in a natural reflexive activity by turning away from intolerable pain just as one would pull away one’s hand from a hot plate. In the case of momentous threats or adversity involving trauma, this mechanism may serve to protect the child against excessive pain (i.e., above the threshold that the child can handle) and consequent disability or injury that may emanate from complete recollection, realisation and experience of the actual event. Therefore, pain becomes stored within the child. In the case of minor primal scenes, pain is stored collectively. Each time a child’s needs are not met, more weight is added to his/her pool of hurts, or to what Janov (1973: 25) refers to as the “primal pool.” As the pain must be somehow released, the system automatically acts pain out. This means that “unnatural inclinations become the norm as the person [child] cannot feel his natural inclinations” (Janov, 1973: 61). For instance, the release may come in dreams or nightmares (cf. p. 148), the perpetual smile that says: “be nice to me” (cf. p. 3.3, 115), or in the look that says: “please approve of me” (cf. 3.3, p. 105). Signs of poor hygiene, for instance, Dikeledi’s untidy, dirty hair; physical ailments such as Zandi’s painful eyes, the sores on Lebo’s legs, her runny nose and infected eyes; and behavioural signs such as Lebo’s crying and Zandi’s boisterousness and aggression, indicate a need for care (Miller, 2005: 134), whereas jealousy or shunning behaviour towards other children (cf. 3.1, p. 158-9; 3.2, p. 159) may importune the need for attention, respect and importance.

In view of this, defences are inherently identified as *involuntary*, that is, the automatic responses of the mind and the body to primal pain, or *voluntary*, which refers to defences such as excessive exercise, compulsive eating, smoking, drug or alcohol abuse, that come into play, and are necessary to relieve excess tension when involuntary release mechanisms fail to block actual feelings. Involuntary forms of release pertaining to the children in the research group included fantasising, bedwetting, sighing, nightmares, blinking and tightening of muscles. There are two types of built-in defences: tension releasing and tension building. For example, when bedwetting occurs, conscious defences are lessened and tension is released involuntarily; whereas knotting of the stomach muscles, for instance, holds feelings down, resulting in tension (Janov, 1973: 60-1). Accordingly, the resultant disorganisation or “imbalances in homeostasis or disruption” (Kumpfer, 1999: 183) that transpires when children experience pain or hurt and the resultant tension take the form of “feeling disconnected from consciousness” (Janov, 1973: 24). “At the primal scene the child’s organism shuts down against full realisation and becomes unconscious of this realisation in the same manner that pain can render the staunchest of us unconscious” (Janov, 1973: 39). Without that necessary connection, the child does not feel which may, in turn, result in the need to feel - such as, to be loved, held and caressed, that is part of the need to be stimulated. When these needs are not met, children may respond, for instance, by suppressing their feelings and becoming “unreal,” covering their feelings with a façade required by others in an attempt to fulfil needs of their own. Consequently, children are not free to truly

experience the simplest of feelings such as contentment, anger, rage, pain, even hunger, and naturally, enjoyment of their own bodies (Miller, 2005: 46). Lisebo is one of the younger children in day care at Lebone. Supposedly, her unmet needs include the need for attention, stimulation and recognition. She has learnt that in order to meet these needs, she must meet the needs of her teacher by adopting a specific mode of conduct and by performing certain activities:

“Lisebo, she’s three years old. She was like a little lazy, at first, neh. So, I adore small babies doing funny things and stuff, she was a quiet child and stuff. I didn’t like that, because I want her to be [she makes a gesture, indicating that she would like her to be more lively], so when they moved to the school, then I used to give her skipping rope. I say hold that side, I hold this side, then she’ll do. She couldn’t do it at first, and she didn’t like it because she was struggling to do as I do, but even, even if she picks up her hand once, I say Yahhh! Shout at her, then she gets excited, then until she liked what I was doing. Then everyday her mother will tell me, whooooh, we didn’t sleep last night. Why? Lisebo, she would say, she couldn’t even pronounce it, cause she was still young, Tess, she would call me Tess, instead of Mistress. Then her mother says when she talks, she’s just you. She’ll talk with your action, she shouts. Now when I take out skipping rope, I must be there, no matter what I’m doing. I must be there. And one style that she learns, besides what I’ve taught her, I must do it. So now all of them, there are four of them. Its Lisebo, Phutheho, Tebatso, and, whooooh, I must always be there skipping (she laughs), even if I’m not there and then they’re playing, when they hear my voice, you’ll see them pulling it behind them, Mistress come. I must jump once or twice then they’re satisfied.”

In this sense, defences are, on the whole, what is expected of the child. The child submits and sacrifices his/her true self in order to cover the feeling of being unloved, and in this way, personality (i.e. the characteristic way in which a child thinks and behaves as he/she adjusts to his/her environment) becomes constructed around, and forms an integral part of defences (McConnell, 1974: 633).

Children may also revert to former observations as a means of defence, for example:

“With the small children what we experience, eh, they don’t play with their private parts, but they sleep on top of the other. Especially that happens on Mondays during afternoon nap or while they’re playing they will go behind the classroom and they will try to have sex there [meaning that they mimic the act, not necessarily fully engaging in the act], then the bigger ones will say they’re doing silly things. So, with that we don’t just become hard, I believe not to be harsh on kids and stuff. So I try to ignore, though observing in a way, until I go to, we do home visits and I see the situation in the house. Who’s living in the house, how many people, how many rooms, how do they sleep. Then you’ll find that these kids, that one that always experience intercourse. They see it at home. It’s only a two room shack, and there are two couples inside, some of the couples, some are mother or father, or boyfriend, girlfriend, they’re irresponsible, because they do it when they are drunk in front of the kids. So, and small kids they love you, and then they see that my mother and the boyfriend is on top and that he’s not crying. So, it’s not a bad thing that they are doing.”

I contend that by this means, children seek pleasant sensations to ease unconscious painful feelings, but because all suppressed feelings are painful, these children simply constantly exchange one painful sensation for another in the hope of overcoming the pain. By acting out an old non-conceptualised need, the child might label it differently, namely sex, but the need remains, for instance, to be held. Only when the child stops the act (i.e. the sedative) and is held (i.e. someone recognises the need), he/she can truly feel. He/she can conceptualise the need and not act it out symbolically (Janov, 1973: 73). I conclude that physical activity, imitating the action of perceived phenomena (i.e. physical contact or sex), actually builds bodily or behavioural signifiers that refer to phenomena (for instance, love and/or the need for it) in a comparable way to that by which mental symbols refer to these phenomena.

In terms of development, this view underpins Piaget's concept of developmental schemes, of assimilation, accommodation and equilibrium (cf. 3.2.2.2, p. 60-1); it correlates with social learning theory, as it acknowledges that children learn ways of behaving vicariously through observation; and confirms Pajaras's (n.d.: 3 of 10) stance (cf. p. 60) that reproduced (observed) behaviour is a product of mental imagery (symbols), association and ascribed meaning, retained in memory, which signifies the child's capability to symbolise. In view of this, I infer, in the presence of an absent reality, that the mind automatically presents (the correct) mental images (acquired through the process of accommodation and assimilation) to the body, informing thoughts and actions so that needs can be satisfied directly and survival can be ensured. Hence, children develop by means of a series of experiences and associations that connect with, and lead to the formation of symbols or internal images that intimately interweave with children's defences, behaviour, knowledge and pending experiences. An illuminating example, particularly with regard to the older children, was related during an informal conversation with the social worker at Lebone. She mentioned that many of the children, including some of the children in the research group, periodically asked for medication, saying that they had stomach ache, but when merely given vitamin syrup, they reported relief from such an ailment. For these children, the act of administering and receiving "medication" (which may signify a re-enactment of, or symbolise the primal mother-child relationship) may conceivably have brought relief as it denoted maternal presence, care, understanding, compassion, comfort and healing. I construe that these present, and perhaps also past unfulfilled needs result in tension which may explain the physical discomfort experienced by these children. It follows that it is often more acceptable or allowable for children to have physical hurts, such as stomach aches, but not emotional aches, such as feeling sad. Therefore, the child's hurt is directed toward physical ailments, that is to say, acted out symbolically, when all he/she is perhaps trying to say is: "I am sad." However, this disconnection of thought from its feeling content (early in life) may produce continuous uncomfortable sensations, such as headaches, backaches and allergies that will persist until correctly conceptualised and connected to their specific traumatic origins - when it becomes a feeling (Janov, 1973: 70-1; Miller, 2005: 66).

As discussed in the literature review, I deduce from the above that mental representations and patterns of action simultaneously and specifically structure a child's knowledge, which also implies that the more self-actualised and self-transcendent they become, children develop wisdom and automatically know what to do in a variety of situations. In view of this, I also gather that accessibility and availability of assets or resources, and more specifically, the expectations and allowances placed on children from specific external sources,

may direct their hurt and determine the adaptive pathways they follow. This position also coincides with social learning theory, since the extent of reinforcement received from external sources influences the adaptive pathways children follow. Therefore, when needs remain unrecognised and unattended to, and children are unable to access their inner and external resources, so as to attend to their needs, and because it would be unbearable to experience their pain all alone, they are compelled to suppress their feelings. The simple lack of not having a parent around, or alternative care as needed, may create so much emptiness and pain that the child shuts off his pain by shutting off his primal need(s). Characteristically, institutionalised children are known to numb or “deaden themselves,” becoming seemingly apathetic, dazed and lifeless, creating a barrier in order to survive (Janov, 1973: 65-6, McConnell, 1974: 243).

As observed and gathered during the empirical investigation, children may stop speaking or revert to single words, lose bowel or bladder control, and withdraw into themselves. This means of defence was particularly evident in two of the children in the research group, Kagiso and Khaya. The self-soothing, rocking motions exhibited by Lebo during one of the interviews (akin to the motions mothers often use to comfort or soothe their infants when they are distressed) also suggest self-reliance as part of the defence system, and a means of protecting the self against psychic breakdown. This picture may be a powerful symbol of attachment and loss, and possibly shows a child trying to integrate with and adjust to her present external environment. If the personality cannot bind tension, symptoms such as, bedwetting, masturbation, nail biting or thumb sucking may result. When these avenues for more relief are not permitted and resolved appropriately, the child may be forced to find more hidden (and perhaps more allowable) means of protection (Janov, 1973: 62). A child's feelings cannot be suppressed without serious consequences though, for “the stronger the prisoner is, the thicker the prison walls have to be, and unfortunately these walls also impede or completely prevent later emotional growth” (Miller, 2005: 68). Viewed in terms of Maslow's theory, this implies that regressive forces may stifle development, resulting in maladaptation (stagnation). It follows that in such instances, unattained developmental tasks give way to mistrust, shame, guilt, or inferiority, and associated depression, signalling a very early injury. Thus, children's denial of their own emotional reactions, that is to say, what constitutes a denial of the self, begins in service of an essential adaptation during childhood. Hence, depression, experienced as painful bodily sensations, hides deep and painful feelings from proper recognition, for example: “They don't love me.” Once recognised, the child may experience old, forgotten situations consciously, in their full tragedy, for losses to be mourned at last. Yet, a child may not have this mechanism and insight open to him. “He cannot yet see through his mechanism of self-deception and, on the other hand, he is far more threatened than an adult by the intensity of his feelings if he does not have a supportive, empathic environment,” (Miller, 2005: 66-7). Consequently, children may be in actual external danger.

On a positive note, metaphorically speaking, these children relapse or recoil into a state of hibernation, often followed, at some point, by a growth curve. I contend that, in such instances, the development of competencies often reveals children's particular innate strength(s) or “islands of competence,” and by implication, their coping mechanism(s) which may bring concepts such as “selective perception” into play (cf. p. 24). The formation of these “islands of competence” often reflects children's interests, shape their identity, and guide their actions, as well as direct and determine the life paths, specifically, their careers. Given this perspective, deprivation may signal an opportunity for growth or the development of competencies

related to different life tasks (cf. Figure 3.6). Viewed in terms of Maslow's theory, this implies that growth forces will motivate and create an upward movement in the hierarchy (cf. Figure 6.2) towards a pattern of positive adaptation (i.e. the development of competencies) by means of an active will to survive.

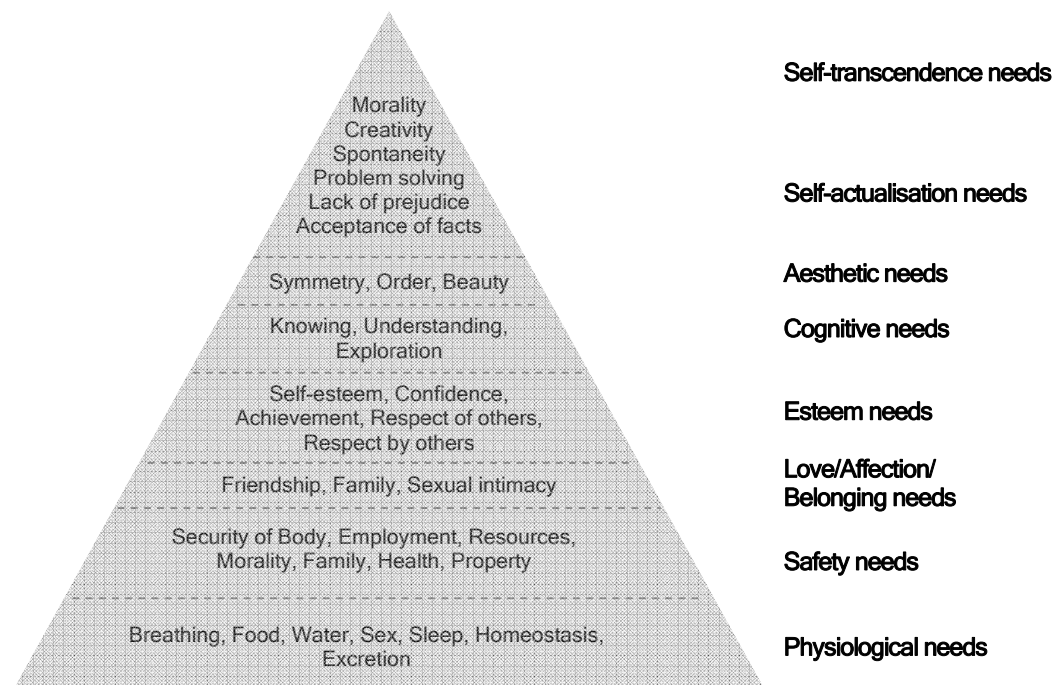

Figure 7.2: Maslow's hierarchy of needs

Source: Adapted from Greene (2002: 12) and Zalenski & Raspa (2006: 1121).

Thus, in such instances, the adaptive function of the defence system is to sustain or “keep the organism going” (Janov, 1973: 61), thereby trying to ensure survival until the child has reached the ability, capacity and knowledge (maturity) to resolve primal scenes. My basic assumption is that human behaviour is always purposive and goal-directed. In one way or another, children will continually strive to maintain homeostasis, a state of balance or equilibrium (i.e. health) while interacting with the environment, and continually strive to actualise their potential by attempting to meet their physiological, psychological, safety, cultural and spiritual needs. As needs are satisfied, goals are realised. Therefore, I conclude that human needs constitute the major factor in the establishment of goals. Needs can be blocks or stimuli to learning, are socially derived, and the means by which needs are satisfied are culturally derived. In light of this, true self-worth, hope and resilience may be based on the children's experiencing success in areas of their lives which they and others deem important.

2.2 Psychological resilience

The conceptual emphasis that emerged from the literature review (Chapters 2 & 3) was that resilience is a dynamic process rather than a fixed attribute, and that it comprises various constructs and processes which do not necessarily constitute specific stages or phases, but rather occur across the lifespan in conjunction with a range of adversities and stressors. Concomitantly, woven in a web of relationships and experiences over the course of a life lived from birth to death, resilience takes on different forms: anomic survival (children or families who are in a continual state of disruption or chaos); regenerative resilience (encompasses incomplete attempts to develop competence or constructive coping mechanisms); adaptive resilience (relatively sustained periods of use of competence and coping strategies), and flourishing resilience (extensive use of effective behaviour and coping strategies) (Greene & Conrad, 2002: 39). Thus, to reiterate, in relation to the resolution of developmental issues and life tasks, the child shows the tendency to achieve “wholeness, not as a static state, but as a dynamic, flexible balance that permits recoil or regression and rebound or progress” (Murphy, cited in Kaplan, 1999: 64). As such, I theorise that for the children selected for this study, psychological resilience may involve the constant resolution and mediation of their past, present and future. Hence, their capability to understand the event, to believe that they control the event because they know they have some control over what happens (self-efficacy) (also cf. 3.2.2.1, p. 55-60), and to give deeper meaning to an adverse event (insight and transcendence) becomes fundamental in coping with adversity, ensuing pain, loss and grief. In this process, underlying (primal) pain becomes the motivating factor in meeting the need to survive and to be whole again, while unnatural tension drives the child towards resolution. Accordingly, children display a self-actualising tendency that emerges through personal interaction with the environment and the beginning of self-awareness, jointly, referred to as the primal process, in other words, a release of pain. There are two main underlying aspects to this theory, namely the process of coming to know and the stages through which children move as they gradually acquire this ability.

In my opinion, the development of self-awareness encompasses the growing ability to perceive one's own existence in association with one's feelings, thoughts and behaviours. Therefore, self-awareness constitutes the recognition of one's personality, strengths or traits, weaknesses, preferences and interests. The attainment of self-awareness implies finding answers to or gaining knowledge and insight about one's own existence, in other words, one's past, present and future. The child's answers to questions concerning life leave traces in his/her development.

As suggested in the previous section, children have developmental needs. Need deprivation threatens survival. Pain is simply a sign of this threat. If there are no means to fulfil needs, repressive forces will restrain the need (Janov, 1990: 17-8). Repression effectively produces two selves: the *real self*, laden with needs and pain, and the *unreal self*, the self out of touch with the real self, but still able to manage the outside world. For the unreal self the present is but a trigger that sets off old needs and hurts in an attempt to resolve them. The role of the unreal system is to screen, filter or block memories that may lead to suppressed pain (Janov, 1973: 44, McConnell, 1974: 616). Therefore, not only pain, but also the child's memory of parts of his/her history, remains hidden. In a sense, this may be equated to, what Bovensiepen (2002: 242-3) refers to as loss of symbolic function (cf. Chapter 3, p. 20). The resolution of pain follows a natural process. Memories are

stored and remain in the system until the child is older and stronger, and thus able to deal with them. These memories are stored as they contain the keys to future survival. Like the brain, the body remembers its deprivations and needs. Triggered by a later event, these memories rise to the surface for resolution and integration. Resolution of pain, among other aspects, involves a release of pain for “it is tears that help dissolve the boundaries of the unconscious” (Janov, 1990: xxiv) and “liberates encapsulated pain” (Janov, 1990: 328). To recapitulate, children effectively deal with pain by means of connection. By becoming self-aware, and progressively feeling the pain, memory, insight and natural equilibrium are restored (Janov, 1973: 45; Janov, 1990: 25). Adler (1938: 41) concludes that all memories carry a specific goal: motivation and warning. I believe that memories also shape our interests, values and ideas. Therefore, memories are fruitful for the development of a specific psychological path or route. Insight involves a sudden reconstruction of the child’s perceptual world into a new configuration (gestalt). Hence, development of a rich social memory or archive of symbols (mental imagery) of alternative situations and responses may enhance children’s capacity to adapt to their environment. The advancement of this frame of reference entails the accumulation of social assets in the form of networks of trust, shared knowledge and actual materials needed to facilitate those responses.

Viewed in terms of the paradigm of resilience, the underlying components, resources and developmental building blocks, necessary for the promotion of self-awareness and, concurrently, the perceived (ego) competence to satisfy subsequent needs and reinforce feelings and beliefs that support resilience are indicated in Table 7.1.

TABLE 7.1: Paradigm of resilience		
Component	Definition	Building blocks
I HAVE	External supports: Supports around each individual to promote resilience	<p>Trust: Developed during infancy</p> <ul style="list-style-type: none"> • Main question asked: "Is my world predictable and supportive?" • Central task: Receiving care • Positive outcome: Trust in people and the environment • Ego quality: Hope • Definition: Enduring belief that one can attain one's deep and essential wishes • Developmental task: Social attachment; maturation of sensory, perceptual, and motor functions; primitive causality. • Significant relations: Maternal parent
I AM	Encouragement in developing the inner strengths of confidence, self-esteem, and responsibility	<p>Autonomy : Starts to develop at the age of two</p> <ul style="list-style-type: none"> • Main question asked: "Do I need help from others or not?" • Central task: Imitation • Positive outcome: Pride in self; assertion of will in the face of danger • Ego quality: Will • Definition: Determination to exercise free choice and self-control • Developmental task: Locomotion; fantasy play; language development; self-control • Significant relations: Parents <p>Identity: Starts to develop at the age of eleven</p> <ul style="list-style-type: none"> • Main question asked: What is my goal in life? • Central task: Peer group; cliques • Positive outcome: A strong group identity; ready to plan for the future • Ego quality: Loyalty • Definition: Ability to freely pledge and sustain loyalty to others • Developmental task: Physical maturation; emotional development; membership in peer group; sexual relationships • Significant relations: Peer groups
I CAN	Acquisition of interpersonal and problem-solving skills	<p>Initiative : Starts to develop at the ages of four and five</p> <ul style="list-style-type: none"> • Main question asked: "How moral am I?" • Central task: Identification • Positive outcome: Able to initiate activities and enjoy learning • Ego quality: Purpose • Definition: Courage to imagine and pursue valued goals • Developmental task: Sex-role identification; early moral development; self-esteem; group play; egocentrism • Significant relations: Basic family <p>Industry : Starts to develop at the age of six</p> <ul style="list-style-type: none"> • Main question asked: "Am I good at what I do?" • Central task: Education • Positive outcome: Acquire skills for and develop competence in work; enjoy achievement • Ego quality: Competence • Definition: Free exercise of skill and intelligence in completion of tasks • Developmental task: Friendship; skill learning; self-evaluation; team play things. • Significant relations: School

Source: Based on Gladding (2000: 190), Greene (2002: 12-3), Grotberg (2003: 5-12; 1995: 6-36 of 43); McConnel (1974: 581, 624- 628).

To illustrate: if children do not learn to trust themselves, others and the world, they may lose the virtue of hope, which is directly linked to this concept. Hope provides comfort while enduring life's threats and personal challenges. Thus, if children lose their belief in hope they will struggle with overcoming adversities and failures in their lives, and may never fully recover from them. This may then prevent them from learning

and maturing into the people they were meant to be. Competence, for example, is the outward growth of the fourth stage of ego development, namely: industry versus inferiority. This ego quality depends strongly on the sustained presence of a supportive caring adult (mentoring).

As suggested in the literature review, each stage builds on the successful completion of earlier stages. I gather that the challenges of stages not successfully completed, reappear as problems in the future. Thus, the extent of past resolution will determine the future. True resilience requires that children not only develop self-awareness to facilitate access to external and internal sources, but also to effectively deal with their pain. In light of this, resilience may be described as a process of disillusionment.

2.3 Contextual specificity of resiliency processes and action or interaction strategies

“Context refers to the particular set of conditions and intervening conditions, the broader set of conditions in which the phenomenon is couched” (Pandit, 1996: 8 of 18). The factors or intervening conditions that affect resilience are considered to be the in-born aspects or characteristics of a child; love and support or lack thereof from family or carers, including one long-term committed loving person; support available within the child's community - peers and adults, including a consistently supportive listener; and the successful or unsuccessful experience of facing challenges. Viewed in terms of a relational model of the self, depicted in Figure 7.2, these conditions are organised according to four encompassing, interacting, evolving factors, namely (1) context, (2) mind, or cognitive processes such as thoughts and emotions, (3) body, or physical aspects, and (4) spirit, or metaphysical or innate forces.

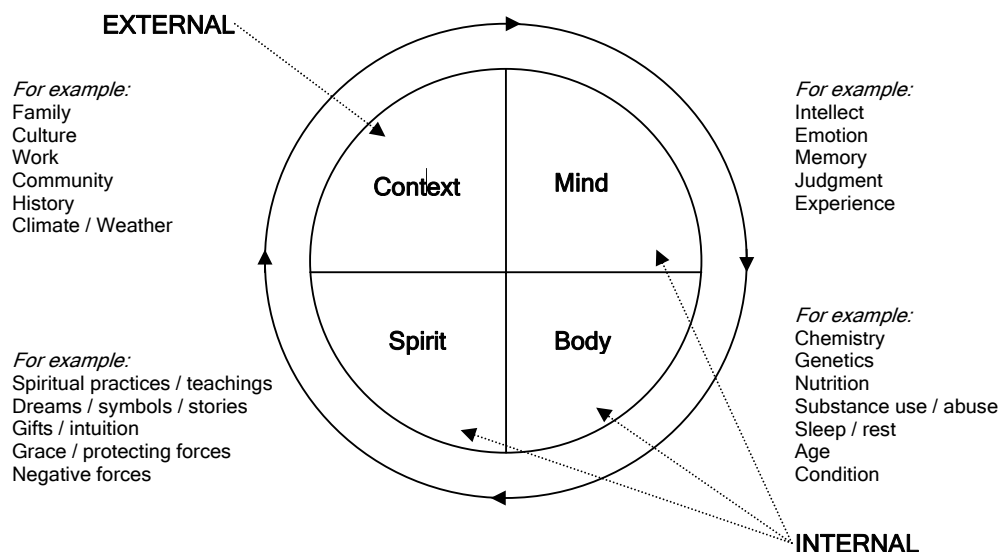

Figure 7.3: The relational worldview model

Source: Adapted from Greene *et al.* (2002: 261).

This model assumes that nothing in the sphere can change without every other aspect in the sphere changing too. Change is constant due to the cycles of the days, weeks and seasons, and because of development and changing experience. Balance between these four parts leads to harmony, thus, health or well-being and resilience (Greene *et al.*, 2002: 261). Hence, psychological resilience and healing may be initiated from any of the four parts in the sphere. For the children in the research group, religion, faith and spirituality may be an important component in the healing process as it gave them a sense of connectedness to the self and others, and an ability to see the larger meaning and purpose to the events of their lives.

In short, as suggested in the previous section, children's resilience is contingent upon and determined by the internal and external resources available to them. This invariably holds the concepts of *relatedness* - attachment and bonding - as well as *multiple systems of influence and interaction*, including the family, school, neighbourhood, community and culture (Cowie & Smith, 1988: 8-10; Greene, 2002: 18; Killian, 2004: 2 of 15; Masten, 2005: 29; Papalia & Olds, 1993: 14).

Children's fundamental developmental needs are met through relatedness and bonding - from caring relationships, high expectations, and opportunities for meaningful participation. The biological capacity to bond and form attachments is genetically determined as children are born with biological needs and a basic drive to survive (Greene, 2002: 11; Heylighen, 1992: 39; Janov, 1973: 29; 1990: 3-5; McConnell, 1974: 630; Perry, 2001: 3). These capacities establish the basis on which the child forms relationships with others;

his/her sense of security about exploring the world; his/her resilience to stress; his/her ability to balance his/her emotions, make sense of his/her life, and create meaningful interpersonal relationships. Specific kinds of interplay, communicated during the interviews with some of the children in the research group and their caregivers, observed between these two parties, that signify bonding included eye contact, touch, laughing, feeding, holding, talking and singing and mirroring or recognising the child's unique qualities. These kinds of interplay may foster resilience in these children by creating feelings of safety and predictability that forms the foundation for positive mental health (Perry, 2001: 4).

The relational conditions that specifically affect resilience are thought to include responsiveness (Sheridan *et al.*, 2005: 168), desire, allowance or willingness (trust), and accessibility on both sides (i.e. the child and the individual with whom the child shares a relationship). I believe that these conditions may also relate to the extent of pain and evidently the inbuilt defences that children might hold, and thus determine the level of true intimacy between them and others. Noticeably, during the empirical investigation, some children, apparently in a lot of emotional pain, seemed to cringe when touched. Arguably, limited intimacy may be a protective mechanism - a kind of "adaptive distancing" - or "a silent scream for help and the fulfilment of unmet needs." It also follows that children who are handled well, that is to say nurtured and loved, develop trust and security and a basic optimism, while children who are badly handled (i.e. abused for the sake of adults' needs by being exploited, beaten, punished, taken advantage of, manipulated, neglected, or deceived without the intervention of any witness) become insecure and mistrustful. On the other hand, children who are badly handled are vulnerable and in need of love, and may therefore be drawn to anybody willing to show them affection. Unfortunately, these people may also abuse them. It is therefore critical that vulnerable children learn that the people known to them, and those who "love" them, are not necessarily good for them - they may merely act as if they love them. For this reason, it is crucial that younger children, in particular, who find themselves in an environment such as Lebone "where everybody is safe and everybody loves them," know the difference between appropriate and inappropriate affection (and touch), that is to say, between love and exploitation or abuse, and that they realise that not all people can be trusted. In other words, trust should be established first before children allow a person to show them affection and love them. Therefore, the ways in which children seek to avoid or establish contact with the present environment are considered a significant factor when recovering from psychological disturbances. From this, I also gather that because "[true or sincere] love is an essential quality in the fulfilment of needs at every level of development and is contained in the satisfaction of all needs" (Janov, 1990: 5), it is the key determining factor (condition) that underpins all the previously mentioned relational conditions.

As needs are met, children develop the strengths (developmental outcomes) that will benefit them throughout their lives, and that are necessary for future happiness and success. As suggested previously and illustrated in Figure 7.4, these attributes emerge from interplay between genetic and environmental influences (Deater-Deckard *et al.*, 2005: 53).

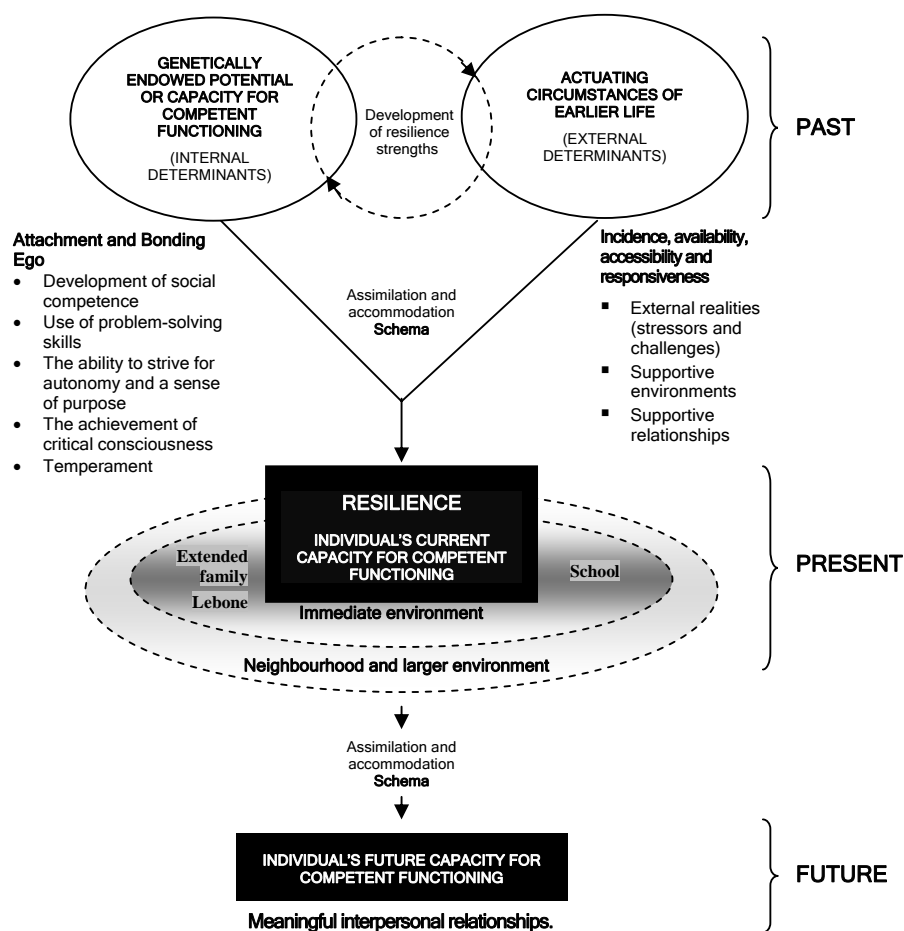

Figure 7.4: Ecological perspective of resilience in children

Source: Adapted from Powers (2002: 166).

The child must assemble and organise all his/her relations with others in his/her environment, in his/her psyche ("ziel") and this becomes the plan for adaptation, the vehicle for developing the abilities that are paramount for self-protection and that form an essential part of the child's existence (Adler, 1938: 41). The dual process, assimilation-accommodation, enables the child to form a plan. This process is directed to a balance between the structure of the mind and the environment, and to advance children's understanding of their world and their competency in it. During this on-going relationship with the environment, the child exhibits certain organisations based upon assimilation and accommodation (cf. p. 60-61). Over time, by means of these organisations, children develop cognitive styles to explain events in their lives. These cognitive styles are based on interpretations of external events, and capture the past, present and future in what may be referred to as "personality scripts" (Gladding, 2000: 250-1). These scripts also reflect three functional ego states, namely the child, parent and adult. Berne (1964: 364) defines an ego state as "a

consistent pattern of feeling and experience directly related to a corresponding consistent pattern of behaviour.”

The child ego state, the part of the personality characterised by childlike behaviours and feelings, develops first and consists of two subdivisions, namely the *natural child* and the *adaptive child*. The natural child is spontaneous, impulsive, feeling orientated, often self-centred and pleasure loving, as well as intuitive, creative and responsive to non-verbal messages. The adaptive child is the compliant part of the personality, associated with the use of defences, as it conforms to the wishes and commands of the parental figures. As suggested in paragraph 3.1 of this Chapter, these adaptations occur in response to trauma, natural life experiences and training. The parent ego state incorporates the attitudes and behaviours of parental figures and is subdivided into the *nurturing parent* (who comforts, praises, and assists others) and the *critical parent* (who finds fault, displays prejudices, disapproves and prevents others from feeling good about themselves). The adult ego state is not age-related and is the objective, thinking, data-gathering part of the personality. This ego state represents the rational, organised part of the personality that tests reality (Gladding, 2000: 246-7).

Hence, personality scripts determine how children interact with others. Transactions or stimulus-response patterns, based on the various ego states, occur on one of three levels: complementary (i.e. both parties are operating from the same ego state or complementary ego states, for example, parent to child, or adult to adult), crossed (meaning an inappropriate ego state is activated), or ulterior (i.e. two ego states operate simultaneously and one message disguises the other) (Berne, 1964: 28-32; Gladding, 2000: 247-9). Complementary transactions and positive messages, given to children and that function as permissions, may facilitate the formation of constructive scripts that foster resilience, whereas crossed and ulterior transactions, and negative messages or injunctions, are more powerful and become the basis for destructive scripts that may cause dysfunctional integration (cf. p. 35). Viewed in terms of Maslow and Erickson's theories of human development, if children's needs for autonomy, for example, are not met, children may turn against their urges to manipulate and discriminate. Thus, disassociated from the original cause, children's feelings of anger, helplessness, despair, longing, anxiety, and pain may find expression in constructive or destructive acts against others (for instance, criminal behaviour or mass murder), or against themselves (for instance, drug addiction, alcoholism, psychic disorders, or suicide) (Miller, 2005: 154).

Transactional analysis theory holds that individuals can change despite the unfortunate events of their past (Gladding, 2000: 246). In a conscious attempt to overcome negative messages or injunctions, in other words, destructive scripts that may cause a wretched life (Gladding, 2000: 250), resilient children may build constructive, healthy lives by way of selective perception (cf. p. 24) and “cognitive reframing” (cf. p. 24; Boyd, 1992: 14 of 23-4), or “re-authoring” (i.e. the identification and co-creation of alternative storylines of identity) (Carey & Russell, 2003: 60-70), and subsequently, the configuration of a strong internal locus of control (cf. p. 28 and 57; Figure 3.5). In this regard, spirituality may play a fundamental role for the children in the research group, as it could assist the reframing process and the internalisation of positive life scripts, and foster ego qualities such as hope, will, purpose and perceived competence (cf. Table 7.1) that play a fundamental role in initiating and facilitating this process. In addition, the children's perspective on

humankind's spiritual nature may have an important influence on their social values, morality and self-concepts, and thereby define the vision of who they are as human beings. This may affect the dreams and goals that children develop, and how they pursue them. In this pursuit, spiritual truths may thus become the tools children use to guide their lives.

Spirituality is a quality inherent to the specific culture and contexts in which the children find themselves. Similarly, as suggested previously, other cultural qualities and features or communicative symbols occurring within a specific environment could become part of children's cognitive schemes or life scripts, and are primarily incorporated, internalised and utilised in action and interaction strategies through play. By manipulating these symbols during play, children are essentially thinking, in the absence of the actual objects involved. Imitative formations provide the basis for building mental symbolic activity (cf. p. 60-2). Children may assume stereotyped character roles drawn from the culture at large, such as nurse, and fictional character roles drawn from books and television. Though meanings associated with these symbols or roles often reflect real world behaviour, they also seem to incorporate children's interpretations and needs. Thus, along with symbolisation, there is a clear understanding of the past, present and future. For instance, the need for maternal protection and care is evident in the game Lebo plays with the other children: she collects them in a steal pipe structure and takes care of them. This not only points to the needs of the children with whom Lebo plays, but possibly also communicates her similar needs. It follows that present behaviour based on feelings denied in the past is symbolic. Through some present confrontation, the child tries to fulfil an old need. In this way, the relationship between children and their environment - whether they have or have had friendly or adverse relationships with others - are revealed through play (Adler 1938: 75).

Ultimately play, and activities such as (paid) work, domestic responsibilities, helping and caring for others through volunteering, sports or cultural pursuits share a common feature, namely the promotion of self-efficacy and self-esteem that enable children to exert agency over their environment and build constructive lives. In conclusion, viewed within the broader developmental context, four main interrelated factors allow movement from stage to stage, namely maturation, experience, social interaction, and equilibration which occurs when the child combines maturation, experience, and social interaction in order to build a mental plan in order to achieve cognitive coherence and stability.

2.4 Consequences

When some or all of the above are positive, a child may develop a sense of belonging and security, a sense of worth (positive self-esteem) and competence, a sense of mastery and control (self-efficacy), and a realistic understanding of his/her strengths and limitations (self-awareness). Moreover, children may cultivate and own beliefs that are fundamental to resilience and relate to these qualities, namely, "I CAN" (self-efficacy), "I HAVE" (a sense of belonging and security) and "I AM" (positive self-esteem and self-awareness). Children may thus gain access to their earlier experiences; to the parts of themselves and their fate previously hidden to them. Once children experience the breakthrough of intense painful early childhood feelings, characterised by the specific quality of non comprehension, they may discover that they are no longer able to follow the

former pattern of disappointment, suppression of pain, and depression, since they now have a new way of dealing with disappointment, namely experiencing the pain. On the positive side, there is freedom from old programming and self-imposed limitations. The reward is self-empowerment by means of deep insight and feeling.

3. FROM THEORY TO PRACTICE, INTERVENTION OR PREVENTION

Considering practice, intervention and prevention strategies and guidelines based on the living theory presented previously, key concepts such as resilience, feeling, and creativity offer a particularly thoughtful overview of what might be needed by those who have been orphaned by AIDS and have come to live in a place of refuge such as Lebone Land.

Creative activities or art expression, in particular drawing, addresses the sensory experiences inherent to trauma. Drawing is a natural mode of communication that children rarely resist, and it offers a means of conveying the complexities of painful experiences, repressed memories, or unspoken fears, anxieties, or guilt in a manner that is less threatening than strictly verbal means (Malchiodi, 2001: 2 of 14). Drawings expediently bring issues relevant to treatment to the surface, thus helping children to instantly communicate concerns and problems. For these reasons, drawing is a potent tool in fostering resilience in children as it facilitates adaptation, resolution or the “rebuilding of consciousness” (Vasilyeva, 2000: 6), and recovery from adversity. Hence, art is a modality thought well-suited for intervention or prevention purposes with children who have lost their parents to AIDS.

Bovensiepen (2002: 241) argues that engaging in creative processes may help children gradually develop a symbolic space and contain a psychic space in their minds in which they can come to terms with loss and deal with feelings of anger, guilt, rejection, and grief by means of symbolic functioning. Such functioning is characterised by the use of mental symbols, words, or pictures that represent something that is not physically present (DeLoache, 1991: 736). By means of symbolisation, children can gain new knowledge by reflective thought processes, and transform transient experiences into internal models or guides for action to gain insight and solve problems by making sense of their own psychological processes (Bandura, 1986: 18; Bovensiepen, 2002: 242). The value of symbolism (art) clearly lies in the fact that it “is an instrument of knowledge and the most ancient fundamental method of expression, one that reveals aspects of reality, which escape other modes of expression” (Cooper, 1978: 7). For adults (practitioners), children’s art offers a window into their emotions, it provides information about their developmental and cognitive functioning; and it presents an opportunity for further engagement (Demarrais, 1995: 64).

Based initially on the insights of Gestalt psychology and traditional psycho-analysis, Gestalt therapy has developed as a humanistic psychotherapeutic model, with a well-developed theory that combines creative, phenomenological, existential, and dialogical field approaches to the process of transformation and growth

(resilience) (Ament-Lyon, 2001: 225-230, Gladding, 2000: 221; Koffka, 1928: 43-68). The underlying principles and objectives of this therapeutic approach correlate noticeably with the theoretical perspective of psychological resilience presented in this chapter. These objectives are to help children obtain greater independence (freedom and responsibility) in their actions, and to promote self-awareness and insight (to become aware of their own feelings and behaviours, and their effect upon their environment in the present). Hence, this approach helps children to confront the blockages that prevent them from developing naturally and from engaging in self-healing. The Gestalt view of human nature places trust on the inner wisdom of individuals (Gladding, 2000: 222); it is associated with self-actualisation, based on the notion of a complete organism (mind and body as an integrated whole); it requires that persons recognise internal needs and learn how to positively direct those needs, and master their environment. Thus, in view of the living theory of psychological resilience presented previously, this therapeutic approach appears to be valuable in fostering resilience or promoting positive developmental outcomes in children.

In terms of the results of this study, a range of specific activities or guidelines emerge from the study. These may be employed with significant effect by caregivers and educators by means of:

Communication:

- Communicating with children by discussing the day's events, including observations, feelings and ideas.
- Encouraging children to use communication and problem-solving skills to resolve interpersonal problems or to seek help.
- Encouraging communication so that issues, expectations, feelings, and problems can be discussed and shared (Grotberg, 1995: 29 of 43).
- Actively listening to children.
- Providing unconditional love, both physical and verbal.
- Praising children for their accomplishments.
- Allowing children to express the full range of their emotions.
- Adopting a vocabulary of resilience (for instance, "I know *you can* do it") and focusing on children's strengths.

Discipline:

- Employing measures or strategies to achieve personal change and facilitate a strong sense of coping efficacy in children (cf. p. 66).
- Helping children to accept responsibility for their behaviour and to understand that their behaviour has consequences.
- Enforcing rules and other forms of discipline that do not belittle, harm or reject children.
- Offering explanations and reconciliations along with rules and discipline.

Modelling and guidance:

- Modelling behaviour required from children.

- Helping children to employ principles that have a direct impact on efficacy and are important in making choices and taking action to follow life courses (cf. p. 66-7).
- Allowing children, as they develop, to be themselves. In other words, they should be allowed to develop at their own pace, for if children are forced to learn way ahead of time, they cannot be loved.
- Encouraging children to try and do things with minimal adult help.
- Accepting errors and failures, while providing guidance for improvement.
- Reward children's positive stress-coping approaches (Kumpfer & Summerhays, 2006: 156).
- Encouraging children to demonstrate empathy and caring, and supporting their concern for people they do not know.
- Respecting children's feelings.

In addition to these considerations, I believe that in order to help children overcome barriers to a successful transition to adulthood, intervention and prevention programmes should display individual level characteristics (thus, focus or build on strengths that characterise that specific child), target youth early, provide one-on-one attention, be developmentally appropriate, and empower youth.

4. CONCLUDING REMARKS

The primary aim of this qualitative study was to investigate the factors that play an important role in the establishment and sustainment of psychological resilience in a purposive sample of eight pre-adolescent HIV/AIDS-affected children living in a community care facility. This aim was accomplished by achieving the secondary aims of this study, namely to conduct a thorough literature review and empirical investigation, and finally, to formulate a substantive theory of psychological resilience, with regard to the group of children selected for this research. As a result of the accomplishment of these aims, the following main conclusions can be drawn: all children are born to grow, to develop, to live, to love, and to articulate their needs and feelings for their self-protection. When these needs are frustrated, children experience pain, cognitive conflict and tension. I believe, though, that all children experience pain, to varying degrees, during development. However, their responses to these adversities remain key to their survival.

The theory formulated in this chapter recognises social memory and system connectivity as features or key adaptive elements that allow children to retain their heterogeneity while remaining sufficiently flexible to react positively to adversities and changing social contexts. This theory further suggests that resilience requires that children maintain, or rather achieve, a balance between affect (heart), thoughts (mind) and behaviour. This perspective solves the contention regarding the function of resilience, namely whether resilience regulates emotions, behaviour or general adaptation (Harvey & Delfabbro, 2004: 6). I conclude that the function, and concurrently the outcome of psychological resilience include these three aspects, and therefore constitute a delicate balance and integration of emotions, behaviour and general adaptation. Thus, although this study focused on psychological resilience, it has become evident that it does not function alone, but encompasses and strongly relates to the biological (spiritual and behavioural) component(s) of children's make-up. Ultimately, with reference to a prayer written by Reinhold Niehbur (1986: 251) in the late 1930s to

early 1940s, resilience encompasses the serenity to accept, with grace, the things that cannot be changed (Paul Doyle, 2007: 1 of 3; Sifton, 2003: 18). In other words, resilience requires awareness or the presence of mind in the here and now, viewing the reality of whatever conditions and circumstances that may be occurring, acknowledging the truth of reality, and that it cannot be changed. To this may be added, the courage to change the things that can be changed, referring to the ability to confidently (i.e. the belief, "I can") make the necessary, responsible decisions, and take action. Resilience also embraces wisdom - a trait acquired through the experience of life, which involves a recognition and remembrance of the things that do or do not coincide with reality, that do or do not work, and that are true and honest, for that is the meaning of truth - to know the difference (i.e. judgement) (Sifton, 2003: 277).

While this study focused on certain traits as potentially important for resilient pre-adolescents affected by HIV/AIDS living in a community care facility, a number of significant characteristics may operate to promote positive outcomes, and have yet to be explored. Such potential factors may include humour, intimacy, spirituality, self-esteem, ego-resilience and talents. Newly identified inner strengths (such as accountability, dedication, assertiveness, and authority), interpersonal problem-solving skills (such as obedience and acceptance), and gender differences regarding inner strengths (such as morality, social values and resistance skills, optimism and positive identity, and religion and faith) require further investigation. Moreover, further exploration and refinement of the formulated theory pertaining to this study is recommended. A focus area might be, for instance, the influence of cultural meanings, attributed to trauma, on the resilience of the children in the research group.

As this study was not meant to answer questions about long-term outcomes, longitudinal studies, that may be better suited for such conclusions, are recommended. Three types of longitudinal research designs are suggested, namely (1) short-term, transactional, longitudinal studies, (2) prospective, developmental studies, and (3) prospective, multi-sample studies. Short-term, transactional, longitudinal studies are considered to be more powerful due to the opportunity to access resilience over a few months to a few years. These designs are also useful to determine the impact of risks, protective factors and processes pertaining to the children's current and future situations. Then again, long-term prospective developmental studies (no control group), conducted over a more extended period allow researchers to examine a specific group over many years and conduct numerous follow-up assessments. This design seems particularly useful to ascertain the impact of resilience (as posited in 2.2 of this Chapter) on the life adjustment of the children chosen for this study. Prospective, multi-sample studies may be useful to compare children in the general population with a high-risk population over time. Use of this type of design is valuable in that it may provide researchers with answers to the question of whether the most resilient individuals of a high-risk group are truly resilient or are simply the best of a generally poor functioning group. This design could be used with many prevention studies where one group is given an intervention and the other not. A general population sample exists for comparison (cf. Dugan & Coles, 1989; Kumpfer, 1999: 186-88; Lazarus, 2004: 6). Thus, such studies may also provide researchers with further answers regarding the relationship between resilience and institutionalisation versus foster care within children's communities, and allow for research aimed at programme development and improvement.

List of references

A

Abdool Karim, S.S. 2005. Introduction. In: Abdool Karim, Q. & Abdool Karim, S.S. *HIV/AIDS in South Africa*. New York: Cambridge University Press, 31-36.

Abdool Karim, Q., Abdool Karim, S.S. & Baxter, C. 2005. Overview of the book. In: Abdool Karim, Q. & Abdool Karim, S.S. *HIV/AIDS in South Africa*. New York: Cambridge University Press, 37-47.

Adler, A. 1938. *Menschenkennis*. Utrecht: Erven. J. Bijleveld.

Ah Shene, D. 1999. Resiliency: A vision of hope. *Developments*, 18(7). Edmondton: AADAC (Alberta Alcohol and Drug Abuse Commission). An Agency of the Government of Alberta.

(<http://corp.aadac.com/copyright/>)

Accessed on 1 September 2005.

Ament-Lyon, N. 2001. Art and creativity in Gestalt therapy. *Gestalt Review*, 5(4):225-248.

Andrews, G., Skinner, D. & Zuma, K. 2006. Epidemiology of health and vulnerability among children orphaned and made vulnerable by HIV/AIDS in sub-Saharan Africa. *AIDS Care*, 18(3):269-276.

AVERT (AVERTing HIV and AIDS). 2007. AIDS orphans: The facts.

(<http://www.avert.org/aidsorphans.htm>)

Retrieved on 10 May 2007.

B

Babbie, E. 1998. *The practice of social research*. Belmont: Wadsworth Publishing Company.

Babbie, E. & Mouton, J. 2001. *The practice of social research*. Cape Town: Oxford University Press.

Bandura, A. 1963. The role of imitation in personality development. *Journal of nursery education*, 18(3).

(<http://www.des.emory.edu/mfp/Bandura1963.pdf>)

Retrieved on 29 November 2005.

Bandura, A. 1986. *Social foundations of thought and action: A social cognitive theory*. New Jersey: Prentice-Hall Inc.

- Bandura, A. 1994. Self-efficacy. In: Ramachaudran, V. S. (Ed.). *Encyclopedia of human behavior*. New York: Academic Press, (4):71-81.
- Bandura, A. 1995. Exercise of personal and collective efficacy in changing societies. In: Bandura, A. *Self-efficacy in changing societies*. New York: Cambridge University Press, 1-45.
- Bandura, A. 1997. *Self-Efficacy: The exercise of control*. New York: W.H. Freeman Company.
- Barton, H.W. 2002. Methodological square pegs and theoretical black holes. In: Greene, R.R. *Resiliency: An integrated approach to practice, policy and research*. Washington: NASW Press, 95-116.
- Bee, H. 1989. *The developing child*. New York: Harper & Row Publishers Inc.
- Beeld*. 2004. Vreugdelose jeug. 16 Junie:9.
- Bellamy, C. 2004. *The state of the world's children 2005: Childhood under threat*. New York: The United Nations Children's Fund (UNICEF).
- Benard, B. 1991. Prevention should emphasize protective factors. *Western Center News*, 4(4):11-13.
- Benard, B.M.S.W. 2004. The Foundations of the Resiliency Framework: From Research to Practice. Resiliency in Action.
(<http://www.resiliency.com/htm/research.htm#bonnie>)
Retrieved on 29 August 2005.
- Bender, D.E. & Castro, D. 2004. Explaining the birthweight paradox: Latina immigrants' perceptions of resilience and risk. In: Flournoy, R. & Yen, I. *The influence of community factors on health: an annotated bibliography*. A Policy Link Report. California: Policy Link and The California Endowment, 73-74.
- Bentzen, R.W. 2005. *Seeing young children: A guide to observing and recording behaviour*. Canada: Thomson and Delmar Learning.
- Beresford, B. 2002a. A lost generation. *Weekly Mail and Guardian*. 10 October:6.
- Beresford, B. 2002b. Families tipped into destitution. *Weekly mail and Guardian*. 3 October:8.
- Berg, B.L. 2004. *Qualitative research methods for the social sciences*. Boston: Pearson Education Inc.
- Berne, E. 1964. *Games people play*. New York: Simon & Schuster.
- Bhengru, C. 2002. Suffer the children. *Sowetan*. 4 June:9.

- Biehler, R.F. 1981. *Child development: An introduction*. Boston: Houghton Mifflin Company.
- Blum, R.W.M. n.d. Risk and resilience: A model for public health interventions for adolescents. (<http://www.acsa-caah.ca/pdf/ang/riskandresilience.PDF>)
Retrieved on 6 August 2005.
- Bovensiepen, G. 2000. Symbolic attitude and reverie: Problems of symbolization in children and adolescents. *Journal of analytical psychology*, 47:241-257.
- Boyd, G.A. 1992. When you grow up in a dysfunctional family. Mudrashram Institute of Spiritual Studies. (<http://www.mudrashram.com/dysfunctionalfamily2.html>)
Retrieved on 22 November 2005.
- Brannen, J (Ed.). 1992. *Mixing methods: Qualitative and quantitative research*. Vermont: Ashgate Publishing Company.
- Brendtro, L. & Larson, S. 2004. The resilience code: Finding greatness in youth. *Reclaiming children and youth*, 12(4):194-200.
- Brody, E.J. 2005. Get a grip and set your sights above adversity. Personal health. *The New York Times*. 1 March.
(http://www.familiesofseptember11.org/docs/Times_Resilience_030105.doc)
Retrieved on 31 May 2005.
- Bronfenbrenner, U. & Ceci, S.J. 1994. Nature-nurture reconceptualized in developmental perspective: A Bioecological Model. *Psychological Review*, 101(4):568-586.
- Brooks, R.B. 2005. The power of parenting. In: Goldstein, S. & Brooks, R.B. *Handbook of resilience in children*. New York: Kluwer Academic/Plenum Publishers, 297-314.
- Brooks, R.B. & Goldstein, S. 2003. *Nurturing resilience in our children: Answers to the most important parenting questions*. Chicago: Contemporary Books.
- Brummer, W. 2001. Vigswesies. *Burger*. 18 October:1.
- Business Times*. 2003. AIDS leaves 11m orphans in Africa. 11 December:12.
- C**
- Carey, M. & Russell, S. 2003. Re-authoring: Some answers to commonly asked questions. *The international journal of narrative therapy and community work*, 3:60-70.

- Camerer, L. 1996. Crime prevention in context. *Monograph*, 3.
(<http://www.issafrika.org/Pubs/Monographs/No3/CrimePreventionLC.html>)
Retrieved on 3 November 2005.
- Carnegie, R. 2003. CCATH (Child-Centred Approaches to HIV/AIDS) Lessons learned 1. Coping strategies in children and communities: The CCATH project in Kenya and Uganda. Healthlink Worldwide.
(<http://www.healthlink.org.uk/world/ewa1.htm>)
Accessed on 19 January 2006.
- Children on the Brink*. 2004. A joint report of new orphan estimates and a framework for action. New York: TvT Associates/The Population, Health and Nutrition Information Project for the United States Agency for International Development (USAID), the Joint United Nations Programme on HIV/AIDS (UNAIDS) and UNICEF.
- Clarke, L. 2002a. Little box that means the world. *Star*. 5 July:10.
- Clarke, L. 2002b. Protecting memories is vital to the healing process. *Cape Times*. 4 July:6.
- Clarke, L. 2003. Study brings home the suffering Aids is causing the poor. *Cape Times*. 15 January:6.
- Claxton, G. 1999. *Wise up: The challenge of life long learning*. London: Bloomsbury Publishing Plc.
- Chandler, L.A. 1981. The source of stress inventory. *Psychology in the schools*, 18(2):164-168.
- Chung, N. & Ro, G. 2004. The effect of problem-solving instruction on children's creativity and self-efficacy in the teaching of practical arts subject. *The Journal of Technology Studies*, 30(2):116-122.
- Cohen, J. & Epstein, H. 2005. Letting them fail: Government neglect and the right to education for children affected by AIDS. *Human rights watch*, 17(13A):1-57.
- Coles, R. 1989. Moral energy in the lives of impoverished children. In: Coles, R. & Dugan, T.F. *The child in our times: Studies in the development of resiliency*. New York: Brunner/Mazel Inc, 45-79.
- Colker, L.J. 2005. When children read because they want to, not because they have to. Reading is fundamental.
(<http://www.rif.org/coordinators/articles/WhenChildrenRead.msp>)
Retrieved on 27 September 2005.

Comas-Diaz, L., Luthar, S.S., Maddi, R.S., O'Neill, H.K., Saakvitne, K.W. & Tedeschi, G.R. 2004. The road to resilience. The American Psychological Association: APA Help Center.

(<http://www.apahelpcenter.org/featuredtopics/feature.php?id=6&ch=2>)

Retrieved on 27 July 2005.

Consortium for street children. 2004. HIV/AIDS.

(<http://www.streetchildren.org.uk/resources/details/?type=theme&theme=44>)

Retrieved on 25 October 2005.

Constantine, N., Benard, B. & Diaz, M. 1999. Measuring protective factors and resilience traits in youth: The healthy kids resilience assessment. (A Paper presented at the Annual Meeting of the Society for Prevention Research, held in New Orleans, LA, during June.)

(<http://crahd.phi.org/papers/HKRA-99.pdf>)

Retrieved on 26 September 2005.

Cook, P. & Du Toit, L. n.d. Overcoming adversity with children affected by HIV/AIDS in the indigenous South African cultural context. Intervening across cultures and contexts: Children affected by HIV/AIDS in the indigenous South African cultural context.

(<http://web.uvic.ca/iicrd/graphics/Intervening%20Across%20Cultures%20and%20Contexts.pdf>)

Retrieved on 8 May 2005.

Cooper, J.C. 1978. *An illustrated encyclopaedia of traditional symbols*. London: Thames and Hudson Ltd.

Cove, E., Eiseman, M. & Popkin, S.J. 2005. *Resilient children: Literature review and evidence from the HOPE VI Panel study*. Final report. Washington: The Urban Institute.

Cowie, H. & Smith, K.P. 1988. *Understanding children's development*. New York: Basil Blackwell Ltd.

Cullinan, K. 2001. They've only got each other. 18 November:11.

D

Das Eiden, R. 1999. Exposure to violence and behaviour problems during early childhood. *Journal of Interpersonal Violence*, 14(12):1299-1313.

Dawes, A. & Donald, D. 1994. Understanding the psychological consequences of adversity. In: Dawes, A. & Donald, D. *Childhood & adversity: Psychological perspectives from South African research*. Cape Town: David Philip Publishers (Pty) Ltd., 1-27.

Deane, N. 2003. Aids adds to poverty spiral. *Weekly mail and Guardian*. 27 November:6.

Deane, N. 2004. Keeping family in a memory box. *Weekly mail and Guardian*. 9 December:8.

- Deater-Deckard, K., Ivy, L. & Smith, J. 2005. Resilience in gene-environment transactions. In: Goldstein, S. & Brooks, R.B. *Handbook of resilience in children*. New York: Kluwer Academic/Plenum Publishers, 49-63.
- De Bord, K. n.d. Children's needs: Recognizing stress in children. Adapted from the Stress and Coping with Disaster Manual from the University Extension in Columbia, Missouri. Developed during the Flood of 1993. (<http://www.preparerespondrecover.com/childrensneeds/>) Retrieved on 5 August 2005.
- DeLoache, J.S. 1991. Symbolic functioning in very young children: Understanding of pictures and models. *Child development*, 62(4):736-52.
- Demarrais, A. 1995. Mommy and me. In: Geballe, S., Gruendel, J. & Andiman, W. *Forgotten children of the AIDS epidemic*. New Haven: Yale University Press, 64-70.
- Denis, P. 2001. Building resilience by remembering: Memory boxes. *Children First*, 4(34):23-25.
- Dent, R.J. & Cameron, R.J.S. 2003. Developing resilience in children who are in public care: The educational psychology perspective. *Educational psychology in practice*, 19(1):3-19.
- Department of Social Development. 2005a. *Policy Framework for orphans and other children made vulnerable by HIV and AIDS South Africa: Building a caring society together*. (2nd Draft). 11 February. Pretoria.
- Department of Social Development. 2005b. *Policy Framework for orphans and other children made vulnerable by HIV and AIDS South Africa: Building a caring society together*. (3rd Draft). 11 February. Pretoria.
- De Vos, A.S., Strydom, H., Fouche, C.B. & Delpport, C.S.L. 2005. *Research at grass roots: For the social sciences and human service professions*. Pretoria: Van Schaik Publishers.
- Diamond Fields Advertiser*. 2003. We need to save South Africa's future. 28 November:20.
- Donald, D. & Dawes, A. 1994. The way forward: Developmental research and intervention in contexts of adversity. In: Dawes, A. & Donald, D. *Childhood & adversity: Psychological perspectives from South African research*. Cape Town: David Philip Publishers (Pty) Ltd., 261-271.
- Donald, D. & Swart-Kruger, J. 1994. Children of the South African streets. In: Dawes, A. & Donald, D. *Childhood & adversity: Psychological perspectives from South African research*. Claremont: David Philip Publishers (Pty) Ltd., 107-121.

Dondenberg, G.R. & Pao, M. 2005. Youths and HIV/AIDS: Psychiatry's role in a changing epidemic. *Psychiatry*, 44(8):728-747.

Dugan, M.D. & Coles, M.D. 1989. *The child in our times: Studies in the development of resiliency*. New York: Brunner/Mazel Inc.

Dunn, 2004. HIV/AIDS: What about very young children? Findings. Exchange.

(http://www.healthlink.org.uk/PDFs/findings_eed.pdf)

Retrieved on 15 January 2007.

E

Eberson, H. 2001. Die verband tussen kreatiewe denke en psigologiese weerbaarheid by kinders in hulle laat middelkinderjare. Ongepubliseerde M.Soc.Sc.-proefskrif. Bloemfontein: Universiteit van die Vrystaat.

F

Farren, A.M. 2005. How can I create a pedagogy of the unique through a web of betweenness? Unpublished Ph.D. thesis. Bath: University of Bath.

(<http://people.bath.ac.uk/edsajw/farren.shtml>)

Accessed on 15 September 2006.

Felner, R.D. 2005. Poverty in childhood and adolescence: A transactional-ecological approach to understanding and enhancing resilience in contexts of disadvantage and developmental risk. In: Goldstein, S. & Brooks, R.B. *Handbook of resilience in children*. New York: Kluwer Academic/Plenum Publishers, 125-147.

Fetcher, R. & Forel, A. 1935. *Het sexuele vraagstuk*. Amsterdam - Soerabaia: Graauw's Uitgewers -Mij.

Fraser, M.W., Richman, J.M. & Galinsky, M.J. 1999. Risk protection and resilience: Toward a conceptual framework for social work practice. *Social Work Research*, 23(3):131-143.

Freeman, J., Epston, D. & Lobovits, D. 1997. *Playful approaches to serious problems: Narrative therapy with children and their families*. New York: W.W. Norton & Company.

Frohlic, D. & Murphy, R. 2000. The memory box. *Personal Technologies*, 4(4):238-240.

G

Gallagher, C. 2004. An extended family for Aids orphans. *Saturday Star*. 8 May:7.

Garnezy, N. 1991. Resilience in children's adaptation to negative life events and stressed environments. *Pediatric Annals*, 20(9):455-6.

- Garwick, A.E. & Millar, H.E.C. 1995. *Promoting resilience in youth with chronic conditions & their families*. Maternal & Child Health Bureau. Health Resources & Services Administration. U.S. Public Health Service. (<http://www.allaboutkids.umn.edu/kdwbvfc/FamilyMonograph.PDF>) Retrieved on 28 November 2005.
- Gilborn, L.Z., Nyonyintono, R., Kabumbuli, R. & Jagwe-Wadda, G. 2001. *Making a difference for children affected by AIDS: Baseline findings from operations research in Uganda*. New York: The Population Council Inc.
- Gingsburg, K.R. The Committee on Communications & The Committee on Psychosocial Aspects of Child and Family Health. 2007. The importance of play in promoting healthy child development and maintaining strong parent-child bonds. *Pediatrics*, 119(1):182-191.
- Girls, HIV/AIDS and Education*. 2004. A document published as part of UNICEF's work as co-sponsoring agency of UNAIDS. New York: UNICEF.
- Gladding, S.T. 2000. *Counseling: A comprehensive profession*. New Jersey: Prentice Hall.
- Glantz, M.D. & Sloboda, Z. 1999. Analysis and reconceptualization of resilience. In: Glantz, M.D & Johnson, J.L. *Resilience and development: Positive life adaptations*. New York: Kluwer Academic/Plenum Publishers, 109-126.
- Goetz, J.P. & Le Compte, M.D. 1984. *Ethnography and qualitative design in educational research*. New York: Academic Press.
- Golafshani, N. 2003. Understanding reliability and validity in qualitative research. *The Qualitative Report*, 8(4):597-607.
- Goldstein, S. & Brooks, R.B. 2002. *Raising Resilient Children: Fostering Strength, Hope, and Optimism in Your Child*. Chicago: McGraw-Hill Inc.
- Goldstein, S. & Brooks, B.R. 2005. Why study resilience? In: Goldstein, S. & Brooks, R.B. *Handbook of resilience in children*. New York: Kluwer Academic/Plenum Publishers, 3-17.
- Graham, D. 2004. When gogo has to play mama. *Citizen*. 2 December:8.
- Graziano, A.M. & Raulin, M.L. 1989. *Research methods: A process of inquiry*. New York: Harper Collins Publishers.
- Greene, R.R. 2002. Human behaviour theory: A resilience orientation. In: Greene, R.R. *Resiliency: An Integrated approach to practice, policy and research*. Washington: NASW Press, 1-27.

Greene, R.R. & Conrad, A.P. 2002. Basic assumptions and terms. In: Greene, R.R. *Resiliency: An Integrated approach to practice, policy and research*. Washington: NASW Press, 28-62.

Greene, R.R., Taylor, N.J., Evans, M.L. & Smith, A.L. 2002. Raising children in an oppressive environment: Voices of resilient adults. In: Greene, R.R. *Resiliency: An Integrated approach to practice, policy and research*. Washington: NASW Press, 241-264.

Grotberg, E. 1995. A guide to promoting resilience in children: Strengthening the human spirit. From the *Early Childhood Development: Practice and Reflections series*. The Hague: The Bernard van Leer Foundation.

Grotberg, E.H. 2003. *Resilience for today: Gaining strength from adversity*. Westport: Greenwood Publishing Group Inc.

Guest, E. 2003. *Children of AIDS: Africa's orphan crisis*. Scottsville: Pluto Press.

Gulaid, A.L. 2004. The framework for the protection, care and support of orphans and vulnerable children living in a world with HIV and AIDS.

(<http://synkronweb.aidsalliance.org/graphics/OVC/documents/0000292e.pdf>)

Accessed on 18 October 2005.

Ntshingila, F., Gules, N. & Pather, S. 2005. The elderly shall provide. *Sunday Times*. 6 February:8.

H

Haan, N. 1989. Coping with moral conflict as resiliency. In: Dugan, M.D. & Coles, M.D. *The child in our times: Studies in the development of resiliency*. New York: Brunner/Mazel Inc., 23-42.

Haight, L.W. 1998. "Gathering the spirit" at First Baptist Church: Spirituality as a protective factor in the lives of African American children. *Social work*. 43(3):213-221.

Hall, D.K. & Pearson, J. 2003. Resilience: Giving children the skills to bounce back. *Voices for children: Advancing knowledge and ideas for the well-being for Ontario's young people report*. Reaching in... reaching out project, during November. Ontario: Toronto & Guelph.

(<http://www.voicesforchildren.ca/report-Nov2003-1.htm>)

Retrieved on 15 October 2005.

Hamill, K.S. 2003. Resilience and self-efficacy: The importance of efficacy beliefs and coping mechanisms in resilient adolescents. *Colgate University Journal of the Sciences*, 35:116-146.

Hancock, B. 2002a. Trent focus for research and development in primary health care: An introduction to qualitative research.

(<http://www.trentfocus.org.uk/Resources/Qualitative%20Research.pdf>)

Retrieved on 3 August 2004.

Hancock, B. 2002b. Trent focus for research and development in primary health care: An introduction to qualitative research.

(<http://www.trentfocus.org.uk/Resources/Qualitative%20Process.pdf>)

Retrieved on 3 August 2004.

Hartog, M. 2004. A self study of a higher education tutor: How can I improve my practice? Unpublished Ph.D. thesis. Bath: University of Bath.

(<http://people.bath.ac.uk/edsajw/hartog.shtml>)

Accessed on 14 September 2006.

Harvey, J. & Delfabbro, P.H. 2004. Psychological resilience in disadvantaged youth: A critical overview. *Australian Psychologist*, 39(1):3-13.

Health link Worldwide & CCATH partners (ACET Uganda, KANCO, NACWOLA, Child-to-Child Uganda and Child-to-Child Trust UK). 2004. Final Evaluation of the Project on child-centered approaches to HIV and AIDS Report.

(http://www.healthlink.org.uk/PDFs/ccath_ev.pdf)

Accessed on 29 March 2006.

Heylighen, F. 1992. A cognitive-systemic reconstruction of Maslow's theory of self-actualization. *Behavioral science*, 37:39-57.

Hippe, J. 2004. Self-awareness: A precursor to resiliency. *Reclaiming children and youth*, 12(4):240-242.

Hoepfl, C.M. 1997. Choosing qualitative research: A primer for technology education researchers. *Journal of Technology Education*, 9(1):47-63.

Howard, S. & Johnson, B. 2000. Resilient and non-resilient behaviour in adolescents. *Australian Institute of Criminology: trends and issues in crime and criminal justice*, 183:1-6.

Huitt, W. 2004. Observational (social) learning: An overview. Educational Psychology Interactive. Valdosta, GA: Valdosta State University.

(<http://chiron.valdosta.edu/whuitt/col/soccog/soclrn.html>)

Retrieved on 10 October 2005.

Hyatt, J. 1986. Analysis of qualitative data. In: Ritchie, J. & Sykes. *Advanced workshop in applied qualitative research*. London: Social and Community Planning Research, 32-39.

Interagency Coalition on AIDS and Development (ICAD). 2002. Best practices for care of AIDS orphans.

(http://www.icad-cisd.com/pdf/publications/e_orphans_web.pdf)

Retrieved on 30 June 2006.

I

International HIV/AIDS Alliance. n.d. Stigma and discrimination.

(<http://www.ovcsupport.net/sw3085.asp>)

Retrieved on 19 October 2005.

International Social Service & UNICEF. 2004. Care for children affected by HIV/AIDS: The urgent need for international standards. Improving protection for children without parental care.

(http://www.unicef.org/protection/files/HIV_NOTE_FINAL.pdf)

Retrieved on 9 February 2006.

J

Jackson, H. 2002. *AIDS Africa: Continent in crisis*. Zimbabwe: SAfAIDS.

Janov, A. 1973. *The primal scream*. London: Sphere Books Ltd.

Janov, A. 1991. *The new primal scream: Primal therapy twenty years later*. London: Sphere Books Ltd.

Johnson, J.L. 1999. Resilience as transactional equilibrium. In: Glantz, M.D. & Johnson, J.L. *Resilience and development: Positive life adaptations*. New York: Kluwer Academic/Plenum Publishers, 225-228.

Johnson, L. & Dorrington, R.E. 2001. The impact of AIDS on orphanhood in South Africa: A quantitative analysis. Monograph No. 4. Cape Town: Centre for Actuarial Research.

(http://www.commerce.uct.ac.za/Research_Units/CARE/Monographs/Monographs/mono04.pdf)

Retrieved on 15 June 2005.

Jolley, P.R., Bekhit, N.S. & Thomas, G.V. 2005. The use of drawing for psychological assessment in Britain: Survey findings. *Psychology and Psychotherapy: Theory, Research and Practice*, 78:205-217.

Jordan, V.J. 2005. Relational resilience in girls. In: Goldstein, S. & Brooks, R.B. *Handbook of resilience in children*. New York: Kluwer Academic/Plenum Publishers, 79-105.

K

Kanner, A.D., Coyne, J.C., Schaefer, C. & Lazarus, R.S. 1981. Comparison of two modes of stress management: Daily hassles and uplifts versus major life events. *Journal of Behavioural Medicine*, 4(1):1-37.

- Kalideen, N. 2003. Women bear the brunt of 11-million Aids orphans. *Pretoria News*. 27 November:5.
- Kaplan, H.B. 1999. Toward an understanding of resilience. In: Glantz, M.D. & Johnson, J.L. *Resilience and development: Positive life adaptations*. New York: Kluwer Academic/Plenum Publishers, 17-83.
- Kelle, U. 2005. "Emergence" vs. "Forcing" of empirical data? A crucial problem of "Grounded Theory" reconsidered. *Forum Qualitative Social Research [On-line Journal]*, 6(2), Art. 27.
(<http://www.qualitative-research.org/fqs-texte/2-05/05-2-27-e.pdf>)
Retrieved on 15 June 2005.
- Kersting, K. 2004. Lower family stress tied to improved child behavior. *Monitor on psychology*, 35(8):13.
- Killian, B. 2004. A Generation at Risk? HIV/AIDS, Vulnerable Children and Security in Southern Africa. Monograph, 109.
(<http://www.iss.co.za/pubs/Monographs/No109/Chap3.htm>)
Retrieved on 23 November 2005.
- Kingdon, G. & Knight, J. 2005. Unemployment, race and poverty in South Africa: Overview. Global Poverty Research Group.
(<http://www.gprg.org/themes/t2-inc-ineq-poor/unem/unem-pov.htm>)
Retrieved on 24 October 2005.
- Koffka, K. 1928. On the Structure of the Unconscious. In: Knopf, A. A. *The unconscious: A symposium*. New York: A.A. Knopf, 43-68.
- Kota, N. 2005. Children caring for children. *Daily Dispatch*. 2 February:5.
- Kumpfer, K.L. 1999. Factors and processes contributing to resilience: The resilience framework. In: Glantz, M.D. & Johnson, J.L. *Resilience and development: Positive life adaptations*. New York: Kluwer Academic/Plenum Publishers, 179-224.
- Kumpfer, K.L. & Summerhays, J.F. 2006. Prevention approaches to enhance resilience among high-risk youth: Comments on the papers of Dishion & Connell and Greenberg. *Annals of the New York Academy of Sciences*, 1094 (1), 151-163.
- Kvale, S. 1996. *Interviews: An introduction to qualitative research interviewing*. Thousand Oaks: Sage.
- L**
- Lacter, E. 2005. Why Children Play. Center for Play and Art Therapy.
(<http://truthbeknown2000.tripod.com/>)
Retrieved on 31 October 2005.

- Lai, K.L.C. 2000. Primary prevention in child and adolescent psychiatry: An overview. *Hong Kong J Psychiatry*, 10(3):37-42.
- Lamb, E.M. & Brown, A.D. 2006. Conversational apprentices: Helping children become competent informants about their own experiences. *British Journal of Developmental Psychology*, 24:215-234.
- Lazarus, A. 2004. Relationship among indicators of child and family resilience and adjustment following the September 11, 2001 tragedy. The Emory Center for Myth and Ritual in American Life. Working Paper No. 36. (http://www.marial.emory.edu/pdfs/wp019_02.pdf)
Accessed on 29 March 2006.
- Leedy, D.P. 1985. *Practical Research: Planning and Design*. New York: Macmillan Publishing Company.
- LeFebvre, E.J. 2003. Parenting the preschooler. Self-regulation. (<http://www.uwex.edu/ces/flp/pp/pdf/selfreg.pdf>)
Retrieved on 3 February 2006.
- Levy, P. 2003. Developing 'living theory' in educational informatics: A positional paper for the ALT Learning Theory SIG. (http://homepages.north.londonmet.ac.uk/~cookj/alt_lt/Levy.htm)
Retrieved on 15 September 2006.
- Lilienfeld, S.O., Wood, J.M. & Garb, H.N. 2005. What's Wrong with This PICTURE? *Scientific American Mind*, 16(1):50-8.
- Lincoln, Y.S. & Guba, E.G. 1985. *Naturalistic inquiry*. Newbury Park, CA: Sage.
- Lofland, J. 1971. *Analysing social settings*. Belmont C.A.: Wadsworth.
- Louw, J. 2000. Improving practise through evaluation. In: Donald, D., Dawes, A. & Louw, J. *Addressing childhood adversity*. Cape Town: David Phillip, 60-73.
- Luthans, F. & Youssef, C.M. 2004. Human, social, and now positive psychological capital management: Investing in people for competitive advantage. (http://www.bus.umich.edu/Positive/POS-Research/Reading/luthans_youssef_2004.pdf)
Retrieved on 25 November 2005.
- Luthar, S.S., Cicchetti, D. & Becker, B. 2000. The construct of resilience: A critical evaluation and guidelines for future work. *Child Development*, 71(3):543-562.

M

Madlala, B. 2003. Aids orphans' burden. *Daily News*. 2 December:6.

Malchiodi, A.C. 2001. Using Drawing as Intervention with Traumatized Children. *Trauma and loss: Research and Interventions*, 1(1).

(<http://www.tlcinst.org/drawingintervention.html>)

Retrieved on 10 April 2007.

Mallmann, S. 2003. *Building resilience in children affected by HIV/AIDS*. Namibia: Longman Namibia Inc.

Manaster, G.J. 1977. *Adolescent development and the life tasks*. Boston: Allyn & Bacon Inc.

Marano, E. 2003. The art of resilience. *Psychology today magazine*, May. New York: Sussex Publishers.

(<http://cms.psychologytoday.com/articles/pto-2822.html>)

Retrieved on 7 June 2005.

Masten, A.S. 2005. Resilience in children at-risk. *RESEARCH/Practice*, 5(1).

(<http://www.education.umn.edu/carei/Reports/Rpractice/Spring97/resilience.html>)

Retrieved on 16 July 2005.

Masten, A.S. & Coatsworth, J.D. 1998. The development of competence in favorable and unfavorable environments: Lessons from research on successful children. *American Psychologist*, 53(2):205-220.

Mastropieri, A.M. & Scruggs, E.T. 2000. *The inclusive classroom: Strategies for effective instruction*. New Jersey: Merrill Publishers.

Mather, N. & Ofiesh, N. Resilience and the child with learning disabilities. 2005. In: Goldstein, S. & Brooks, R.B. *Handbook of resilience in children*. New York: Kluwer Academic/Plenum Publishers, 239-256.

Mathye, L.V. 2000. Guidelines for parents, teachers and professionals in the handling of rebellious children.

M.Ed. dissertation. Pretoria: Unisa.

Matthews, D.W. 1993. *Dysfunctional families: The problem behind the problem*. North Carolina: North Carolina Cooperative Extension Service.

McConnell, J.V. 1974. *Understanding human behavior. An introduction to psychology*. New York: Holt, Rinehart and Winston Inc.

Mchunu, N. 2003. Schools 'have a duty to help orphans.' *Pretoria News*. 1 December:2.

- Middel, A.M. 2001. Die verband tussen selfbeeld en psigologiese weerbaarheid by kinders in die laat middelkinderjare. Ongepubliseerde M.Soc.Sc.-proefskrif. Bloemfontein: Universiteit van die Vrystaat.
- Miles, M.B. & Huberman, A.M. 1994. *Qualitative Data Analysis*. London: Sage.
- Milgram, A.N. & Palti, G. 1993. Psychosocial Characteristics of Resilient Children. *Journal of research in personality*, 27:207-221.
- Miller, A. 2005. *The drama of being a child: The search for the true self*. London: Virago Press Ltd.
- Monson, J., Hall, K., Smith, C. & Shung-King, M. 2006. *South African child gauge*. Cape Town: Children's Institute, University of Cape Town.
- Morgan, D.L. 1997. *Focus groups as qualitative research*. (2nd ed). Thousand Oaks: Sage Publications, Inc.
- Morrison, G.M. & Cosden, M.A. 1997. Risk, resilience, and adjustment of individuals with learning disabilities. *Learning Disability Quarterly*, 20:43-60.
- N**
- Naglieri, J.A. & LeBuffe, P.A. 2005. Measuring resilience in children: From theory to practise. In: Goldstein, S. & Brooks, R.B. *Handbook of resilience in children*. New York: Kluwer Academic/Plenum Publishers, 107-121.
- Naidoo, N. 2001. Creating for comfort. *Natal Witness*. 3 November:7.
- Neill, J.T. & Dias, K.L. 2001. Adventure education and resilience: The double-edged sword. *Journal of Adventure Education and Outdoor Leadership*, 1(2):35-42.
- Neuman, W.L. 1997. *Social research methods: Qualitative and quantitative approaches*. Boston: Allyn.
- Neuman, W.L. 2006. *Social research methods: Qualitative and quantitative approaches*. Boston: Pearson Education, Inc.
- Newman, J. 1996. *Wisdom for earthlings: how to make better choices and take action in your life and work*. New York: American Management Association.
- Niebuhr, R. 1986. *The essential Reinhold Niebuhr: Selected essays and addresses*. New Haven: Yale University Press.
- Niemann, R., Niemann, S., Brazelle, R., Van Staden, J., Heyns, M. & De Wet, C. 2000. Objectivity, reliability and validity in qualitative research. *South African Journal of Education*, 20(4):283-286.

Niemann, S.M. 1994. Die bestuursoptrede van die Suid Afrikaanse vrou in die hantering van onderwysverandering. Ongepubliseerde Ph.D.-proefskrif. Bloemfontein: Universiteit van die Oranje-Vrystaat.

Nullis, C. 2004. Body maps for hope and healing. *Natal Witness*. 11 August:10.

O

O'Leary, V.E. 1998. Summer. Strength in the face of adversity: Individual and social thriving- Thriving: broadening the paradigm beyond illness to health. *Journal of Social Issues*.

(http://www.findarticles.com/p/articles/mi_m0341/is_2_54/ai_53489960/print)

Retrieved on 8 May 2005.

PQ

Papalia, D.E. & Olds, S.W. 1992. *Human development*. New York: McGraw-Hill Inc.

Papalia, D.E. & Olds, S.W. 1993. *A child's world: Infancy through adolescence*. New York: McGraw-Hill Inc.

Pandit, N.R. 1996. The Creation of Theory: A recent application of the grounded theory method. *The Qualitative Report*, 2(4).

(<http://www.nova.edu/ssss/QR/QR2-4/pandit.html>)

Retrieved on 14 February 2007.

Pajares, F. n.d. Overview of social cognitive theory and of self-efficacy.

(<http://www.emory.edu/EDUCATION/mfp/eff.html>)

Retrieved on 10 October 2005.

Parachin, V. 2004. Building psychological muscle: Seven steps to becoming more resilient. From: *Vibrant Life*. A Health magazine advocating prevention rather than diagnosis and treatment.

(http://www.findarticles.com/p/articles/mi_m0826/is_3_20/ai_n6170885)

Accessed on 10 August 2005.

Parkinson, F. 2000. *Post-trauma stress: Reduce long-term effects and hidden emotional damage caused by violence and disaster*. Arizona: Fisher Books, LLC.

Patton, M.Q. 2002. *Qualitative research & evaluation methods*. London: Sage Publications Ltd.

Paul Doyle, D. 2007. The History of the Serenity Prayer. Ezine Articles.

(<http://ezinearticles.com/?The-History-of-the-Serenity-Prayer&id=552531>)

Accessed on 03 May 2007

Perry, B.D. 2001. Bonding and attachment in maltreated children. (A booklet, part of the Caregiver Education Series, developed by the ChildTrauma Academy.)

(http://www.childtrauma.org/CTAMATERIALS/AttCar4_03_v2.pdf)

Accessed on 2 April 2007.

Powers, G.T. 2002. Toward a resilience-based model of school social work: A turnaround mentor. In: Greene, R.R. *Resiliency: An Integrated approach to practice, policy and research*. Washington: NASW Press, 153-170.

R

Ragin, C.C. 2002. Introduction: Cases of "what is a case?" In: Ragin, C. & Becker, H. *What is a case: Exploring the foundations of social inquiry*. New York: Cambridge University Press, 1-18.

Raths, L.E. & Metcalf, L. 1945. An Instrument for Identifying Some Needs of Children. *Educational Research Bulletin*, 24(7):169-77, 196.

Ratner, C. 2002. Subjectivity and objectivity in qualitative methodology. *Forum: Qualitative Social Research*. [Online Journal], 3(3).

(<http://www.qualitative-research.net/fqs/fqs-eng.htm>)

Retrieved on 3 October 2006.

Reed-Victor, E. 2003. Supporting resilience of children and youth. Project HOPE: Information Brief No. 1. Williamsburg: Virginia Commonwealth University.

(<http://www.wm.edu/hope/infobrief/Resiliency.pdf>)

Accessed on 22 February 2005.

Reivich, K., Gillham, J.E., Chaplin, M.T. & Seligman, E.M.P. 2005. From helplessness to optimism: The role of resilience in treating and preventing depression in youth. In: Brooks, R.B. & Goldstein, S. *Handbook of resilience in children*. New York: Kluwer Academic/Plenum Publishers, 223-237.

Riley, G.J. 2002. Physical health. In: Greene, R.R. *Resiliency: An Integrated approach to practice, policy and research*. Washington: NASW Press, 171-194.

Roberts, C., Kane, R., Thomson, H., Bishop, B. & Hart, B. 2003. The prevention of depressive symptoms in rural school children: A randomized controlled trial. *Journal of Consulting and Clinical Psychology*, 71:622-628.

Rolf, J.E. & Johnson, J.L. 1999. Opening doors to resilience intervention for prevention research. In: Glantz, M.D. & Johnson, J.L. *Resilience and development: Positive life adaptations*. New York: Kluwer Academic/Plenum Publishers, 229-249.

S

Salaam, T. 2005. AIDS orphans and vulnerable children (OVC): Problems, responses and issues for Congress (A CRS report for Congress). Congressional Research Service, Library of the Congress.

(<http://www.law.umaryland.edu/marshall/crsreports/crsdocuments/RL3225202112005.pdf>)

Accessed on 30 June 2006.

Scales, P.C. 2000. Building student's developmental assets to promote health and school success. *Clearing House*, 74(2):84-88.

Scales, P.C., Benson, L.P. & Roehlkepartain, C.E. 2001. The role of neighbourhood and community in building developmental assets for children and youth: a national study of social norms among American adults. *Journal of Community Psychology*, 29(6):703-727.

Scales, P.C. & Roehlkepartain, C.E. 2003. Boosting student achievement: New research on the power of developmental assets. *Search Institute Insights & Evidence*, 1(1):1-10.

Schenk, K. & Williamson, J. 2005. *Ethical approaches to gathering information from children and adolescents in International settings: Guidelines and resources*. Washington: The Population Council Inc.

Schorr, L.B. 1988. *Within our reach: Breaking the cycle of disadvantage*. New York: Doubleday.

Schunk, D.H. 2001. Social cognitive theory and self-regulated learning. In: Schunk, D.H. & Zimmerman, B.J. *Self-regulated learning and academic achievement: Theoretical perspectives*. London: Lawrence Erlbaum Associates Inc., 125-148.

Sesma, A., Mannes, M. & Scales, C.P. 2005. Positive adaptation, resilience, and the developmental asset framework. In: Goldstein, S. & Brooks, R.B. *Handbook of resilience in children*. New York: Kluwer Academic/Plenum Publishers, 281-96.

Sheridan, M.S., Eagle, J.W. & Dowd, E.S. 2005. Families as contexts for children's adaptation. In: Brooks, R.B. & Goldstein, S. *Handbook of resilience in children*. New York: Kluwer Academic/Plenum Publishers, 165-179.

Sifton, E. 2003. *The Serenity Prayer: Faith and politics in times of peace and war*. New York: W.W. Norton & Company, Inc.

Silverman, D. 1985. *Qualitative methodology & Sociology*. Hants: Gower.

Silverman, D. 2000. *Doing Qualitative research: A practical handbook*. London: Sage Publications.

- Skolnik, L. 2004. *Addressing HIV/AIDS from an intergenerational perspective*. (Background paper for Policy workshop on HIV/AIDS and family well-being, held in Windhoek, Namibia, from 28-30 January.)
- Smaling, A. 1994. *Course material for qualitative methodology*. HSRC Winter School: Pretoria.
- Smetherham, J. 2004. No need to fear Aids orphans - report. *Star*. 31 December:2.
- Smith, C. & Carlson, B.E. 1997. Stress, coping, and resilience in children and youth. *Social service review*, 71:231-256.
- Smith, D. 2001. Magic Touch. *Saturday Star*. 8 December:3.
- Smokowski, P.R. 1998. Prevention and intervention strategies for promoting resilience in children. *Social service review*, 72(3):337-364.
- Star*. 2005. 'Silent tsunami' of Aids turns the elderly into parents again. 20 June:5.
- Staton, T.F. 1963. *Dynamics of adolescent adjustment*. New York: Macmillan Publishing Company.
- Staudiger, U.M., Marsiske, M. & Baltes, P.B. 1993. Resilience and levels of reserve capacity in later adulthood: Perspectives from life-span theory. *Development and Psychopathology*, 5:541-566.
- Stein, J. 2003. *Sorrow makes children of us all: A literature review on the psycho-social impact of HIV/AIDS on children*. Published CSSR Working Paper No.47. Cape Town: Centre for Social Science Research.
- Steinberg, L. & Belsky, J. 1991. *Infancy, childhood, & adolescence: Development in context*. New York: McGraw-Hill Inc.
- Steinberg, L. & Meyer, R. 1995. *Childhood*. New York: McGraw-Hill Inc.
- Steyn, F. 2001. The role of criminology in the training of probation officers specialising in the Free State. Unpublished M.Soc.Sc. thesis. Bloemfontein: University of the Free State.
- Steyn, F. 2005. *Review of South African innovations in diversion and reintegration of youth at risk*. Newlands: Open Society Foundation for South Africa.
- Subbarao, K. & Coury, D. 2004. *Reaching out to Africa's orphans: A framework for public action*. Washington: The World Bank.

Sullivan, B. 2006. A living theory of a practice of social justice: Realising the right of Traveller children to educational equality. Unpublished Ph.D. thesis. Limerick: University of Limerick.

(<http://www.jeanmcniff.com/bernieabstract.html>)

Accessed on 15 September 2006.

Swanepoel, Z.I. 2000. Creating a culture of effective learning through invitational education: A development program for teachers. Unpublished Ph.D. thesis. Bloemfontein: University of the Orange Free State.

T

Talbot, C. 2005. South African strike against unemployment and poverty. World Socialist Web Site.

(<http://www.wsws.org/articles/2005/jul2005/safr-j01.shtml>)

Retrieved on 24 October 2005.

The resilience model of substance abuse prevention. n.d. Risk factors.

(<http://www.sapvc.org/resources/resilience.htm>)

Accessed on 6 July 2005.

Thom, A. 2001. Love and avocados to treat an epidemic. *Star*. 18 October:23.

Thompson, M. n.d. Raising Cain: Boys in focus. A comprehensive Outreach guide.

(<http://www.pbs.org/opb/raisingcain/filmmaker.html>)

Retrieved on 27 January 2006.

Tjaronda, W. 2005. Young rise to HIV challenge. *New Era*. 14 February:1.

Tolan, J. 2005. Voices from rural South Africa. Married woman and AIDS vulnerability: Moving toward female-controlled prevention. *Roosevelt Review*, 1(1):71-84.

Tolfree, D.K. 2003. *Community based care for separated children*. Sweden: Save the children Sweden.

U

Ungar, M. 2003. Qualitative contributions to resilience research. *Qualitative Social Work*, 2(1):85-102.

Uskul, A.K. & Greenglass, E. 2005. Psychological wellbeing in a Turkish-Canadian sample. *Anxiety, Stress, and Coping*, 18(3):269-278.

V

Van Eyssen, B. 2004. Magical journey draws out HIV/Aids kids. *Star*. 29 November:6.

Valiante, G. n.d. *Developmental analysis of self-efficacy*. Self-efficacy: The exercise of control.

(<http://www.des.emory.edu/mfp/effbook5.html>)

Retrieved on 11 October 2005.

Vanderpol, M. 2002. Resilience: A missing link in our understanding of survival. *Harvard Review of Psychiatry*, 10(5):302-306.

Van Dyk, A. 2005. *HIVAIDS Care & counseling: A multidisciplinary approach*. Cape Town: Pearson Education South Africa.

Van Rensburg, H.C.J. 2004. *Health and healthcare in South Africa*. Pretoria: Van Schaik Publishers.

Van Slambrouck, P. 1999. A contrarian's view on human resilience. *The Christian Science Monitor*.

(<http://csmonitor.com/cgi-bin/durableRedirect.pl?durable/1999/12/06/p1s5.htm>)

Retrieved on 22 September 2005.

Varkevisser, C.M., Pathmanathan, I.; Brownlee, A.; 2003. *Designing and conducting health systems research projects. Volume I: Proposal development and fieldwork*. Amsterdam: KIT Publishers.

Vasilyeva, N. 2000. Psychoanalysis in Russia: The past, present and the future. *American Imago*, 1(57):5-24.

WXY

Walliman, N.R. 2004. *Your undergraduate dissertation: The essential guide for success*. London: Publications Inc.

Watkins, M.L. 2002. Listening to girls: A study in resilience. In: Greene, R.R. *Resiliency: An Integrated approach to practice, policy and research*. Washington: NASW Press, 115-131.

Weekly mail and Guardian. 2004. The broken generation. 28 August:31.

Weekly mail and Guardian. 2004. Counting the costs. 9 December:8.

Werner, E.E. 1993. Risk, resilience, and recovery: Perspectives from the Kauai longitudinal study. *Development and Psychopathology*, 5:503-515.

Werner, E.E. 2005. What can we learn about resilience from large-scale longitudinal studies? In: Goldstein, S. & Brooks, R.B. *Handbook of resilience in children*. New York: Kluwer Academic/Plenum Publishers, 91-105.

Wessells, M.G. & Monteiro, C. 2000. Healing wounds of war in Angola: A community-based approach. In: Donald, D., Dawes, A. & Louw, J. *Addressing childhood adversity*. Cape Town: David Philip, 176-201.

Whitehead, J. 1989. Creating a living educational theory from questions of the kind, 'How do I improve my practice?'. *Cambridge Journal of Education*, 19(1):41-52.

(<http://people.bath.ac.uk/edsajw/writings/livtheory.html>)

Retrieved on 14 August 2005.

Williams, N.R. 2002. Surviving violence: Resilience in action at the micro level. In: Greene, R.R. *Resiliency: An Integrated approach to practice, policy and research*. Washington: NASW Press, 195-215.

Williamson, B.J., Karp, A.D. & Dalphin, J.R. 1977. *The research craft: An introduction to social science methods*. Boston: Little, Brown and Company.

Wilson Scott, K. 2004. Relating categories in grounded theory analysis: Using a conditional relational guide and reflexive coding matrix. *The Qualitative Report*, 9(1):113-126.

Winsler, A. 2003. Early language, self-regulation, and motivation. Child Development Research Lab.

(<http://adp.gmu.edu/research/winslab/>)

Retrieved on 6 February 2006.

Winslow, B.E., Sandler, I.N. & Wolnick, A.S. 2005. Building resilience in all children: A public health approach. In: Goldstein, S. & Brooks, R.B. *Handbook of resilience in children*. New York: Kluwer Academic/Plenum Publishers, 337-356.

Wolin, S. 2002. Shifting paradigms: Easier said than done. *Paradigm*, 7(3):10-11.

Wolin, S. & Wolin, S. 1999a. Project resilience. Child, adolescent and adult phases of the resiliencies.

(<http://www.projectresilience.com/framesconcepts.htm>)

Accessed on 6 July 2005.

Wolin, S. & Wolin, S. 1999b. Reframing. Project resilience.

(<http://www.projectresilience.com/framesconcepts.htm>)

Retrieved on 17 July 2005.

Wolin, S. & Wolin, S. 1999c. Resilience as struggle. Project resilience.

(<http://www.projectresilience.com/framesconcepts.htm>)

Retrieved on 6 July 2005.

Wolin, S. & Wolin, S. 1999d. Vocabulary of strengths: The seven resiliencies. Project resilience.

(<http://www.projectresilience.com/framesconcepts.htm>)

Accessed on 6 July 2005.

Work, W.C., Cowen, E.L., Parker, G.R. & Wyman, P.A. 1990. Stress resilient children in an urban setting. *Journal of Primary Prevention*, 11(1):3-17.

Wright, S.R. 1979. *Quantitative methods and statistics: A guide to social research*. London: Sage Publications Inc.

Wright, M.O. & Masten, A.S. 2005. Resilience processes in development: Fostering positive adaptation in the context of adversity. In: Goldstein, S. & Brooks, R.B. *Handbook of resilience in children*. New York: Kluwer Academic/Plenum Publishers, 17-37.

Yin, R.K. 2003. *Case study research: design and methods*. London: Sage Publications Ltd.

Z

Zalenski, R.J. & Raspa, R. 2006. Maslow's Hierarchy of needs: A framework for achieving human potential in hospice. *Journal of Palliative medicine*, 9(5):1120-1127.

Zimmerman, B.J. 2001. Theories of self-regulated learning and academic achievement: An overview and analysis. In: Schunk, D.H. & Zimmerman, B.J. *Self-regulated learning and academic achievement: Theoretical perspectives*. London: Lawrence Erlbaum Associates Inc., 1-37.

Zimmerman, M.A. & Arunkumar, R. 1994. Resiliency research: Implications for schools and policy. *Social Policy Report: Society for research in child development*, 8(4):1-17.

Appendix 1

BIOGRAPHICAL QUESTIONNAIRE

Questionnaire

Instructions: Please complete all of the following questions in pen. All written information will be treated as strictly confidential. If, for any reason, you cannot give the answer to a question, leave it blank, but please try to answer all the items as best you can.

BIOGRAPHIC INFORMATION

Please fill in the participant's:

1. NAME: _____
2. SURNAME: _____
3. DATE OF BIRTH: _____
4. AGE: _____
5. GRADE LEVEL AT SCHOOL: _____
6. HOME ADDRESS (if applicable): _____

-
7. GENDER:

Please mark the appropriate answer with a "x"

- a) Boy (male) b) Girl (female)

-
8. NUMBER OF SIBLINGS (excluding participant):

Please fill in the correct number:

- a) The child has _____ brother(s), aged _____
b) The child has _____ sister(s), aged _____

-
9. PARENTS:

The child still has a:

- a) father b) mother
Yes No Yes No

If the child's mother has died, please mark the cause:

- | | | | | | |
|------------------|--------------------------|---|--------------------------|--|--------------------------|
| a) Car accident | <input type="checkbox"/> | b) Other accident
(for example, person fell,
drowned or died in a fire) | <input type="checkbox"/> | c) Violence
(for example, an attack or
murder) | <input type="checkbox"/> |
| d) AIDS | <input type="checkbox"/> | e) Illness
(for example, TB or cancer) | <input type="checkbox"/> | f) Other causes | <input type="checkbox"/> |
| g) Unknown cause | <input type="checkbox"/> | | | | |

If the child's father has died, please mark the cause:

- | | | | | | |
|------------------|--------------------------|---|--------------------------|--|--------------------------|
| a) Car accident | <input type="checkbox"/> | b) Other accident
(for example, person fell,
drowned or died in a fire) | <input type="checkbox"/> | c) Violence
(for example, an attack or
murder) | <input type="checkbox"/> |
| d) AIDS | <input type="checkbox"/> | e) Illness
(for example, TB or cancer) | <input type="checkbox"/> | f) Other causes | <input type="checkbox"/> |
| g) Unknown cause | <input type="checkbox"/> | | | | |

10. SPOKEN LANGUAGES:

Please mark the appropriate answer with a "x"

The child speaks (first language/home language):

- | | | | | | |
|-------------|--------------------------|--------------|--------------------------|-----------|--------------------------|
| a) IsiXhosa | <input type="checkbox"/> | b) Sesotho | <input type="checkbox"/> | c) Tswana | <input type="checkbox"/> |
| d) English | <input type="checkbox"/> | e) Afrikaans | <input type="checkbox"/> | f) Other | <input type="checkbox"/> |

The child can also speak (a second language):

- | | | | | | |
|-------------|--------------------------|--------------|--------------------------|-----------|--------------------------|
| a) IsiXhosa | <input type="checkbox"/> | b) Sesotho | <input type="checkbox"/> | c) Tswana | <input type="checkbox"/> |
| d) English | <input type="checkbox"/> | e) Afrikaans | <input type="checkbox"/> | f) Other | <input type="checkbox"/> |

In addition to the spoken languages marked above, the child can speak (third language):

- | | | | | | |
|-------------|--------------------------|--------------|--------------------------|-----------|--------------------------|
| a) IsiXhosa | <input type="checkbox"/> | b) Sesotho | <input type="checkbox"/> | c) Tswana | <input type="checkbox"/> |
| d) English | <input type="checkbox"/> | e) Afrikaans | <input type="checkbox"/> | f) Other | <input type="checkbox"/> |

Thank you for your co-operation!

Appendix 2

LETTER REQUESTING CONSENT (LEBONE LAND)



Fakulteit Geesteswetenskappe / *Faculty of the Humanities*
Skool vir Opvoedkunde / *School of Education*
Departement Psigo-Opvoedkunde / *Department Psychology of Education*

2 February 2006

THE TRUST ADMINISTRATOR
LEBONE LAND, 177 SPRINGBOK STREET
BLOEMSPRUIT
9364

Dear Madam

RE: CONSENT TO PARTICIPATE IN RESEARCH

Herewith I request permission to conduct a study at Lebone Land on the psychological resilience of HIV/AIDS-affected children between the ages of nine and thirteen. If granted, this research will be conducted at Lebone Land, over three to four months, this year. The researcher is interested in investigating the factors that play a significant role in the establishment and sustenance of psychological resilience in pre-adolescent HIV/AIDS-affected children. In other words, to investigate factors that help children to cope with and overcome adversities related to HIV/AIDS, for example, stigmatisation, illness and death. While this research may help us to understand more about children's development of skills and characteristics that facilitate resilience, it may also inform strategies or guidelines as to how these qualities may be fostered in children. Therefore, the results of this study may be of particular value to those involved with childcare, education, and the design and implementation of intervention and prevention programmes for HIV/AIDS-affected children.

To assist you in the decision, a brief description of the research is provided. The research consists of two parts:

- (1) Interviews held at Lebone Land with eight children from this facility.
- (2) Interviews held with key individuals involved with the care and education of these children.

The children will meet with the researcher individually on three occasions for more or less an hour per session. An interpreter will also be present at these sessions. In the first session, the children will be asked to draw a picture of themselves and pictures of the most important people in their lives, to tell a story about themselves and to explain why they regard the people in their drawings as important. In the second session, the children are asked to draw a "river of their life," symbolising good times (the river depicted flowing up) and bad or sad times (the river depicted flowing down) in their lives and to communicate their experiences accordingly. In the last session, the children are asked to draw a picture of the happiest and saddest moments in their lives, and again, to relate their experiences accordingly. The time allocated to each session may be extended as required. The reason being, that children may communicate experiences that might be upsetting to them. In such instances, time will be taken to ensure that the child is emotionally stable, before the session is ended. However, a session should not exceed more than two hours.

The second part concerns employees of Lebone Land who are directly involved with the care of the children. The selection of these individuals will be done in accordance with the Administrator of Lebone. The researcher will meet with the employees at Lebone Land once, individually, for two to three hours, per individual. These employees will be questioned about the behaviour of the children, circumstances that the children had been subjected to before they were accommodated at Lebone and challenges that the children might face.

Only children and employees who have been granted permission, and who themselves agree to participate, will be involved in the study. All efforts will be made to ensure confidentiality and additional ethical procedures will be taken to ensure that no harm is done to the children because of the research. Permission may be withdrawn at any time during the investigation. Information based on the results of each child, as well as of the whole group of participants will be provided (anonymously) in the final report of this investigation.

Herewith I would like to assure you that this study, which is part of a *Masters degree in Psychology of Education*, has been reviewed and received clearance through the *Department of Psychology of Education* at the University of the Free State. In addition, it has been approved by the Research Committee at the *Department of Education* at the University and has the support of Prof HCJ van Rensburg and Dr Z Swanepoel (supervisors of this study).

If you have any questions about the study or if you would like additional information to assist you in reaching a decision, please feel free to call me at the Centre for Health Systems Research and Development at the University of the Free State, (051) 401 3682. Should you have any concerns or comments resulting from the children's participation in this study, please contact me, or Dr Zéndré Swanepoel at the Department of Psychology of Education at the University of the Free State, (051) 401 2245. Thanking you in advance for your interest and support of this research.

Yours sincerely,

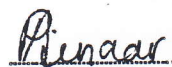

ANJA PIENAAR

Appendix 3

CONSENT FORM (LEBONE LAND)



Fakulteit Geesteswetenskappe / Faculty of the Humanities
Skool vir Opvoedkunde / School of Education
Departement Psigo-Opvoedkunde / Department Psychology of Education

Consent Form

EXPLORING PSYCHOLOGICAL RESILIENCE AMONG PRE-ADOLESCENTS ORPHANED
BY AIDS: A CASE STUDY

Researcher: Anja Pienaar

Kindly peruse and confirm by signing below whether you grant permission. Please return this form to the researcher within three days:

I hereby agree that the prospective study has been explained to me, and I consent to allow the children and key individuals (employees of Lebone Land) selected for the research to participate. I have had an opportunity to ask questions. I understand that the investigator listed above will answer future questions I may have about the research. If I have questions about a child's rights as a subject, I may call the Department of Psychology of Education at the University of the Free State, (051) 401 2245.

Name (please print): A SNYMAN

Signature: *Maylene*

Date: 03-02-2006

Consent is also hereby given to peruse children's records, if & when necessary.

THANK YOU FOR COMPLETING AND RETURNING THIS CONSENT!

Appendix 4

LETTER REQUESTING CONSENT (SHANON INTERMEDIATE SCHOOL)



Fakulteit Geesteswetenskappe / *Faculty of the Humanities*
Skool vir Opvoedkunde / *School of Education*
Departement Psigo-Opvoedkunde / *Department Psychology of Education*

20 February 2006

THE PRINCIPAL
SHANON INTERMEDIATE SCHOOL
PLOT 28, MARTIN ROAD
BLOEMSPRUIT
9364

RE: CONSENT TO PARTICIPATE IN RESEARCH

Dear Madam

Herewith I request permission to conduct research at Shanon Maryvale Primary School on teachers' views concerning the psychological resilience of HIV/AIDS-affected children between the ages of nine and thirteen. This investigation is part of a larger study that aims to investigate the factors that play a significant role in the establishment and sustainment of psychological resilience in pre-adolescent HIV/AIDS-affected children, in other words, investigates factors that help children to cope with and overcome adversities related to HIV/AIDS, for example, stigmatisation, illness and death. While this research may help us to understand more about children's development of skills and characteristics that facilitate resilience, it may also inform strategies or guidelines as to how these qualities may be fostered in children. Therefore, the results of this study may be of particular value to those involved with childcare, education, and the design and implementation of intervention and prevention programmes for HIV/AIDS-affected children.

To assist you in the decision, a brief description of the research is provided. As a whole, the research consists of two parts:

- (1) Interviews held at Lebone Land with eight children from this facility.
- (2) Interviews held with key individuals involved in the care and education of these participants.

The research for which permission is requested concerns the second part, as this involves the teachers of Shanon Intermediate School. Only teachers involved with the education of the children selected to take part in the research and who have been granted permission, and who themselves agree to participate, will be involved in the study. These teachers will meet with the researcher individually on one occasion at the school for more or less 45 minutes per session. The teachers will be asked to express their views regarding the classroom behaviour and academic performance of the children, as well as the challenges faced by the children.

All efforts will be made to ensure confidentiality and additional ethical procedures will be taken to ensure that no harm is done to the children because of the research. Permission may be withdrawn at any time during the investigation. Information based on the results of each child, as well as of the whole group of participants will be provided (anonymously) in the final report of this investigation.

Herewith I would like to assure you that this study, which is part of a *Masters degree in Psychology of Education*, has been reviewed and received clearance through the *Department of Psychology of Education* at the University of the Free State. In addition, it has been approved by the Research Committee at the *Department of Education* at the University and has the support of Prof HCJ van Rensburg and Dr Z Swanepoel (supervisors of this study).

If you have any questions about the study, or if you would like additional information to assist you in reaching a decision, please feel free to call me at the Centre for Health Systems Research and Development at the University of the Free State, (051) 401 3682. Should you have any concerns or comments resulting from the teachers' participation in this study, please contact me, or Dr Zendré Swanepoel at the Department of

Psychology of Education at the University of the Free State, (051) 401 2245. Thanking you in advance for your interest and support of this research.

Yours sincerely,

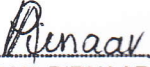
ANJA PIENAAR

Appendix 5

CONSENT FORM (SHANON INTERMEDIATE SCHOOL)



Fakulteit Geesteswetenskappe / Faculty of the Humanities

Skool vir Opvoedkunde / School of Education

Departement Psigo-Opvoedkunde / Department Psychology of Education

Consent Form

EXPLORING PSYCHOLOGICAL RESILIENCE AMONG PRE-ADOLESCENTS ORPHANED
BY AIDS: A CASE STUDY

Researcher: Anja Pienaar

Kindly peruse and confirm by signing below whether you grant permission. Please return this form to the researcher within three days:

I hereby agree that the prospective study has been explained to me, and I consent to allow the teachers selected for the research to participate. I have had an opportunity to ask questions. I understand that the investigator listed above will answer future questions I may have about the research. If I have questions about a child or teacher's rights as a subject, I may call the *Department of Psychology of Education* at the University of the Free State, (051) 401 2245.

Name (please print): Marisa Maboe

Signature: [Handwritten Signature]

Date: 21/02/06

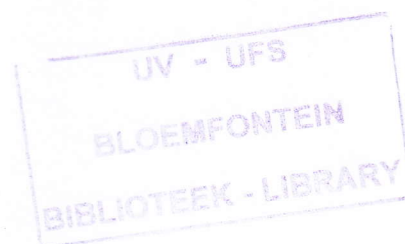

THANK YOU FOR COMPLETING AND RETURNING THIS CONSENT!

